



**ROHDE & SCHWARZ**

Test and Measurement  
Division

## **Operating Manual**

# **AUDIO ANALYZER**

# **R&S UPL/UPL16/UPL66**

**DC to 110 kHz**

**1078.2008.06/16/66**

**Software version UPL 3.00**

*Volume 1*  
*Operating manual consists of 2 volumes*

Printed in the Federal  
Republic of Germany

Dear Customer,

The Audio Analyzer R&S UPL is abbreviated as UPL.

## Tabbed Divider Overview

### Contents

#### Data Sheets

Safety Instructions

Certificate of quality

EU Certificate of Conformity

List of R & S Representatives

### VOLUME 1

#### Tabbed Divider

- 1 Chapter 1: Preparation for Use
- 2 Chapter 2: Manual Operation
- 3 Index

### VOLUME 2

#### Contents

#### Tabbed Divider

- 4 Chapter 3: Remote Control
- 5 Chapter 4: Maintenance
- 6 Annex A UPL Default Setup
- 7 Index



## Contents

### 1 Preparation for Use

<b>1.1</b>	<b>Putting into Operation.....</b>	<b>1.1</b>
1.1.1	Setting up the Audio Analyzer.....	1.1
1.1.2	Rackmounting.....	1.1
1.1.3	Power Supply.....	1.1
1.1.4	Switching On.....	1.3
1.1.6	Connecting an External Keyboard .....	1.4
1.1.7	Connecting a Mouse.....	1.4
<b>1.2</b>	<b>Fitting Options .....</b>	<b>1.5</b>
1.2.1	Enabling Software Options .....	1.5
1.2.2	Installation of Supplementary Software .....	1.6
1.2.3	Installation of Virtual Drive (RAMDRIVE).....	1.7
<b>1.3</b>	<b>Software Installation .....</b>	<b>1.9</b>
<b>1.4</b>	<b>UPL Start Options.....</b>	<b>1.11</b>
1.4.1	Restarting the UPL Software .....	1.11
1.4.2	Integration of Supplementary Programs .....	1.11
1.4.3	Command Line Parameters of the UPL Software .....	1.12
1.4.4	Immediate Effect of Command line Parameters at Power-Up.....	1.14

### 2 Manual Operation

<b>2.1</b>	<b>Explanations of Front- and Rearpanel Views incl. Key Combinations on the External Keyboard.....</b>	<b>2.3</b>
2.1.1	Front-panel View .....	2.3
2.1.2	Rear-panel View.....	2.11
2.1.3	Block Diagram .....	2.12
<b>2.2</b>	<b>Operating Instructions .....</b>	<b>2.13</b>
2.2.1	Brief Introduction .....	2.13
2.2.2	Introductory Examples.....	2.15
<b>2.3</b>	<b>General Instructions for Use .....</b>	<b>2.29</b>
2.3.1	Panels.....	2.31
2.3.2	Data Entry.....	2.34
2.3.2.1	Selecting a Parameter .....	2.34
2.3.2.2	Entry of Numeric Data .....	2.35
2.3.2.3	Using the Softkeys.....	2.36
2.3.2.4	Help Line.....	2.36
2.3.2.5	Entry of File Names .....	2.36
2.3.2.6	Data Input or Output during Measurements .....	2.39

2.3.3	Display of Measured Values .....	2.40
2.3.4	Settling Process .....	2.41
2.3.4.1	Introduction .....	2.41
2.3.4.2	The Settling Parameters: .....	2.42
2.3.4.3	Settling Process with External Sweep:.....	2.47
2.3.4.4	SETTLING Check and Optimization .....	2.48
2.3.5	Status Display .....	2.51
2.3.6	Error Messages .....	2.53
2.3.7	Help Function.....	2.55
2.3.8	Simplification of Panels.....	2.56
<b>2.4</b>	<b>Units.....</b>	<b>2.57</b>
2.4.1	Units for the Display of Measurement Results .....	2.57
2.4.2	Units for the Entry of Values.....	2.61
<b>2.5</b>	<b>Generators (GENERATOR Panel) .....</b>	<b>2.64</b>
2.5.1	Selecting the Generator .....	2.65
2.5.2	Configuration of Analog Generator.....	2.66
2.5.2.1	Unbalanced Output (Output UNBAL).....	2.68
2.5.2.2	Balanced Output (Output BAL) .....	2.69
2.5.2.3	Output Power .....	2.70
2.5.3	Configuration of the Digital Generator.....	2.71
2.5.3.1	Generating Jitter, Phase and Common Mode .....	2.77
2.5.3.2	AES/EBU Protocol Definition .....	2.78
2.5.4	Functions.....	2.85
2.5.4.1	Common Parameters for Generator Signals.....	2.86
2.5.4.1.1	Common Parameters for SINE, DFD, MOD DIST Signals.....	2.86
2.5.4.1.2	Common Parameters for All Generator Functions .....	2.87
2.5.4.1.3	Equalization of the Signals SINE, SINE BURST, DFD, MULTISINE, RANDOM .....	2.88
2.5.4.1.4	Amplitude Variation of the Signals MULTISINE, RANDOM and ARBITRARY .....	2.89
2.5.4.2	Sweeps .....	2.91
2.5.4.3	SINE.....	2.99
2.5.4.4	MULTISINE.....	2.101
2.5.4.5	SINE BURST .....	2.106
2.5.4.6	SINE <sup>2</sup> BURST .....	2.109
2.5.4.7	MOD DIST (Two-tone Signal to SMPTE) .....	2.111
2.5.4.8	DFD (Difference Frequency Distortion) .....	2.114
2.5.4.9	Random (Pseudo Noise) .....	2.117
2.5.4.10	Arbitrary (User-Programmable Signal) .....	2.124
2.5.4.11	POLARITY (Polarity Test Signal).....	2.127
2.5.4.12	FSK (Frequency Shift Keying) .....	2.127
2.5.4.13	STEREO SINE.....	2.128
2.5.4.14	MODULATION (modulated sine).....	2.132
2.5.4.15	DC Voltage.....	2.133
2.5.4.16	Coded Audio (Coded Audio Signals) .....	2.134

2.5.5	Auxiliary Generator.....	2.138
2.5.5.1	Auxiliary Generator Used as Analog Generator .....	2.139
2.5.5.2	Auxiliary Generator Used as Common Mode Generator.....	2.140
2.5.5.3	Auxiliary Generator Used as Jitter Generator.....	2.140
2.5.5.4	Auxiliary Generator Sweep .....	2.141
<b>2.6</b>	<b>Analyzers (ANALYZER Panel) .....</b>	<b>2.142</b>
2.6.1	Selecting the Analyzer.....	2.142
2.6.2	Configuration of Analog Analyzers .....	2.146
2.6.3	Configuration of Digital Analyzer .....	2.153
2.6.3.1	Measurement of Jitter, Phase and Common Mode.....	2.158
2.6.4	Ways of Starting the Analyzer, Ext. Sweep .....	2.159
2.6.5	Functions.....	2.165
2.6.5.1	Common Parameters of Analyzer Functions .....	2.166
2.6.5.2	RMS (incl. S/N) .....	2.178
2.6.5.3	RMS SELECT (Selective RMS Value).....	2.184
2.6.5.4	PEAK, Q-PEAK (Peak and Quasi-peak Weighting incl. S/N) .....	2.196
2.6.5.5	DC.....	2.198
2.6.5.6	THD Measurement .....	2.199
2.6.5.7	THD+N/SINAD Measurement (Total Harmonic Distortion+ Noise) .....	2.203
2.6.5.8	MOD DIST (Modulation Distortion).....	2.212
2.6.5.9	DFD (Difference Frequency Distortion) .....	2.214
2.6.5.10	Wow & Flutter .....	2.217
2.6.5.11	POLARITY (Polarity Test).....	2.219
2.6.5.12	FFT (Spectrum) .....	2.220
2.6.5.13	FILTER SIM .....	2.229
2.6.5.14	Waveform (Display in the Time Domain).....	2.230
2.6.5.15	Protocol Analysis .....	2.234
2.6.5.16	Measurement of Digital Input Amplitude.....	2.234
2.6.5.17	Measurement of Phase between Digital Input and Reference Signal .....	2.234
2.6.5.18	INPUT Display .....	2.235
2.6.5.19	Frequency Measurement.....	2.237
2.6.5.20	Combined Frequency, Phase and Group Delay Measurement .....	2.240
2.6.5.22	Coherence Measurement and Transfer Function.....	2.244
2.6.5.23	Loudspeaker Measurements (RUB & BUZZ) .....	2.246
2.6.5.24	Third Analysis (1/3 OCTAVE).....	2.252
2.6.5.25	12 <sup>th</sup> OCTAVE Analysis (12 <sup>th</sup> OCTAVE).....	2.256
2.6.6	Headphone/Speaker Output.....	2.260
2.6.7	Applications .....	2.266
2.6.7.1	Crosstalk Measurement.....	2.266
2.6.7.2	Linearity Measurements.....	2.268
2.6.7.3	Fast Frequency-Response Measurements.....	2.271
2.6.8	Optimizing the Measurement Speed .....	2.272
1.	Speed Optimization without Affecting Measurement Results.....	2.272
2.	Compromise between Measurement Time and Accuracy or Dynamic .....	2.273
3.	Speed Optimization Through Use of Internal Generator .....	2.274
4.	Optimizing the Speed of Generator Sweeps .....	2.274
5.	Optimized Utilization of DSP Performance with the Clock Rate.....	2.276
2.6.9	Improving the Frequency Response .....	2.277
<b>2.7</b>	<b>Analyzer Filters (FILTER Panel) .....</b>	<b>2.278</b>

2.7.1	Weighting Filters.....	2.279
2.7.2	Creating the User-definable Filters.....	2.284
2.7.2.1	Common Parameters of All Filters.....	2.285
2.7.2.2	Lowpass / Highpass.....	2.286
2.7.2.3	Bandpass / Bandstop.....	2.287
2.7.2.4	Notch.....	2.289
2.7.2.5	Third-octave / Octave.....	2.290
2.7.2.6	Internal Calculation of Filters.....	2.291
2.7.2.7	File-defined Filter ("FILE-DEF").....	2.292
<b>2.8</b>	<b>STATUS Panel.....</b>	<b>2.293</b>
<b>2.9</b>	<b>Series of Measured Values, Files and Loadable Instrument Settings (FILE Panel)...</b>	<b>2.294</b>
2.9.1	Loading and Storing.....	2.294
2.9.1.1	Loading and Storing of Instrument Setups and Complete Setups.....	2.296
2.9.1.2	Loading and Storing of Series of Measured Values and Block/List Data....	2.302
2.9.1.3	Format of Block/List Files.....	2.307
2.9.1.4	Editing Limit Files.....	2.312
2.9.1.5	Generating a Limit file from a Trace File.....	2.314
2.9.1.6	Generating a Limit File using an Application Program.....	2.317
2.9.1.7	Limit Report.....	2.317
2.9.2	Editing Files and Directories.....	2.321
2.9.3	Series of Measured Values (Sweeps and Scans) and Block/List Data.....	2.324
2.9.3.1	Scan count =1.....	2.324
2.9.3.2	Interpolation to a Common X Axis.....	2.325
2.9.3.3	Scan Count >1.....	2.325
<b>2.10</b>	<b>Graphical Data Presentation (DISPLAY and GRAPHICS Panels).....</b>	<b>2.327</b>
2.10.1	Parameters for Display of Traces and Spectra (DISPLAY Panel).....	2.330
2.10.2	Trace and Spectrum Display (GRAPH panel).....	2.337
2.10.3	Parameters for the Display of Lists.....	2.344
2.10.4	Display (GRAPH) of Lists.....	2.346
2.10.5	Parameters for BARGRAPH Display.....	2.347
2.10.6	BARGRAPH Display (GRAPHICS Panel).....	2.349
2.10.7	Limit Check.....	2.350
2.10.8	PROTOCOL Analysis.....	2.352
2.10.9	Switching between Full-screen and Part-screen Mode.....	2.357
<b>2.11</b>	<b>Starting and Stopping Measurements or Sweeps.....</b>	<b>2.358</b>
2.11.1	Overview of Measurement and Sweep Systems.....	2.358
2.11.2	Switching Measurement Modes On and Off.....	2.359
2.11.3	Operating States of Measurement System (No Sweep Active).....	2.360
2.11.4	Overview of Sweep Modes.....	2.361
2.11.5	Switching Sweeps On and Off.....	2.362
2.11.6	Operating States of Sweep System.....	2.363
2.11.7	Operating Modes of External Frequency and Level Sweeps.....	2.367
2.11.8	Several Sweep Traces Displayed in a Diagram.....	2.368



---

<b>2.12</b>	<b>Display of Selected Inputs / Outputs .....</b>	<b>2.370</b>
<b>2.13</b>	<b>Fast Switch-off of Outputs .....</b>	<b>2.371</b>
<b>2.14</b>	<b>Printing / Plotting / Storing the Screen Contents .....</b>	<b>2.371</b>
2.14.1	Screen Copy to Printer (pixel-oriented).....	2.381
2.14.2	Output in HP-GL Format.....	2.383
2.14.3	Output in PCX Format .....	2.383
2.14.4	Output in PostScript Format .....	2.384
2.14.4.1	PostScript Configuration File PS.CFG.....	2.385
2.14.4.2	Integrating and Output of PostScript Files .....	2.387
2.14.5	Output of Measurement Traces and Lists .....	2.389
<b>2.15</b>	<b>Setting and Displaying Auxiliary Parameters (OPTIONS Panel).....</b>	<b>2.390</b>
2.15.1	Selecting the Remote-Control Interface (IEC/IEEE Bus/COM2) .....	2.390
2.15.2	Beeper On/Off.....	2.393
2.15.3	Keyboard Settings.....	2.393
2.15.4	Language of Help Texts.....	2.393
2.15.5	Display Settings .....	2.394
2.15.5.1	Switching the Measurement Display ON/OFF .....	2.394
2.15.5.2	Reading Rate of Measurement Results.....	2.395
2.15.5.3	Resolution of Measurement Results.....	2.395
2.15.5.4	Graphics Display with Selectable Colours .....	2.395
2.15.6	Calibration.....	2.399
2.15.7	Version Display and Service Functions .....	2.401
2.15.8	Transfer of Parameters (Parameter Link Function).....	2.403
2.15.9	Selecting the Sampling Mode .....	2.405
<b>2.16</b>	<b>Macro-Operation.....</b>	<b>2.406</b>
<b>2.17</b>	<b>Connecting External Devices .....</b>	<b>2.408</b>
<b>2.18</b>	<b>UPL Used as Computer.....</b>	<b>2.412</b>
2.18.1	Setting the Realtime Clock .....	2.412

### 3 Remote Control

<b>3.1</b>	<b>Introduction.....</b>	<b>3.1</b>
<b>3.2</b>	<b>First Steps (Read-in of Measured Values) .....</b>	<b>3.3</b>
<b>3.3</b>	<b>Switchover to Remote Control.....</b>	<b>3.4</b>
3.3.1	Setting the Device Address.....	3.4
3.3.2	Indications During Remote Control.....	3.4
3.3.3	Return to Manual Operation.....	3.5
<b>3.4</b>	<b>IEC/IEEE-Bus Messages .....</b>	<b>3.6</b>
3.4.1	Interface Messages .....	3.6
3.4.2	Device-Dependent Messages (Commands and Responses).....	3.6
<b>3.5</b>	<b>Structure and Syntax of Device-Dependent Messages .....</b>	<b>3.7</b>
3.5.1	SCPI Introduction.....	3.7
3.5.2	Command Structure.....	3.7
3.5.3	Structure of a Command Line.....	3.9
3.5.4	Responses to Queries .....	3.11
3.5.5	Types of Parameters .....	3.13
3.5.6	Overview of Syntax Elements.....	3.15
3.5.7	Programming Model of UPL Generator .....	3.16
3.5.8	Programming Model of UPL Analyzer.....	3.17
<b>3.6</b>	<b>Instrument Model and Command Processing .....</b>	<b>3.18</b>
3.6.1	Input Unit.....	3.18
3.6.2	Parser .....	3.19
3.6.3	Setting the Device Hardware .....	3.19
3.6.4	Why is a Specific Operating Sequence Sometimes Required?.....	3.19
3.6.5	Status Reporting System .....	3.21
3.6.6	Output Unit.....	3.21
3.6.7	Triggering a Measurement/Sweep.....	3.21
3.6.8	Command Synchronization.....	3.21
3.6.8.1	Wait for End of Calibration .....	3.22
3.6.8.2	Wait for End of Measurement/Sweep.....	3.22
3.6.8.3	Comparison of Synchronization Capabilities .....	3.24
<b>3.7</b>	<b>Status Reporting System.....</b>	<b>3.24</b>
3.7.1	Structure of SCPI Status Register .....	3.25
3.7.2	Overview of Status Register .....	3.27
3.7.3	Description of Status Registers .....	3.28
3.7.3.1	Status Byte (STB) and Service Request Enable Register (SRE) .....	3.28
3.7.3.2	IST Flag and Parallel Poll Enable Register (PPE) .....	3.29
3.7.3.3	Definition of bits used in the Event Status Register .....	3.29
3.7.3.4	STATus:OPERation Register.....	3.30
3.7.3.5	STATus:QUESTionable Register.....	3.31
3.7.3.6	STATus XQUESTionable Register .....	3.32

3.7.4	Use of Status Reporting System .....	3.33
3.7.4.1	Service Request, Use of Hierarchical Structure .....	3.33
3.7.4.2	Serial Poll .....	3.34
3.7.4.3	Parallel Poll .....	3.34
3.7.4.4	Queries .....	3.35
3.7.4.5	Error Queue Query .....	3.35
3.7.5	Resetting the Status Reporting Systems.....	3.36
<b>3.8</b>	<b>Notation of Command Table .....</b>	<b>3.37</b>
<b>3.9</b>	<b>Common Commands .....</b>	<b>3.39</b>
<b>3.10</b>	<b>IEC/IEEE-Bus Commands.....</b>	<b>3.41</b>
3.10.1	Generators .....	3.41
3.10.1.1	Selection of Generator.....	3.41
3.10.1.2	Configuration of Analog Generators .....	3.41
3.10.1.3	Configuration of Digital Generators .....	3.44
3.10.1.3.1	AES / EBU PROTOCOL Definition.....	3.48
3.10.1.3.2	Auxiliary AUX GEN.....	3.50
3.10.1.4	Generator Sweeps.....	3.52
3.10.1.4.1	Sweep Settings for Auxiliary Generator (AUX GEN).....	3.52
3.10.1.5	Generator Functions.....	3.62
3.10.1.5.1	SINE .....	3.63
3.10.1.5.2	MULTISINE .....	3.65
3.10.1.5.3	SINE BURST .....	3.69
3.10.1.5.4	SINE <sup>2</sup> BURST .....	3.71
3.10.1.5.5	MOD DIST .....	3.73
3.10.1.5.6	DFD .....	3.76
3.10.1.5.7	RANDOM .....	3.79
3.10.1.5.8	ARBITRARY .....	3.83
3.10.1.5.9	POLARITY.....	3.86
3.10.1.5.10	FSK (Frequency shift keying) .....	3.87
3.10.1.5.11	STEREO SINE .....	3.88
3.10.1.5.12	MODULATION (FM or AM signal).....	3.91
3.10.1.5.13	DC voltage.....	3.92
3.10.1.5.14	Coded Audio (Coded Audio Signals).....	3.93
3.10.2	IEC/IEEE-Bus Commands for Analyzers .....	3.97
3.10.2.1	Selection of Analyzer .....	3.97
3.10.2.2	Configuration of Analog Analyzers .....	3.97
3.10.2.3	Configuration of Digital Analyzers.....	3.100
3.10.2.4	Starting the Analyzer, Ext. Sweep .....	3.103
3.10.2.5	Analyzer Functions .....	3.105
3.10.2.5.1	Common Parameters for Analyzer Functions .....	3.106
3.10.2.5.2	RMS Measurement incl. S/N.....	3.108
3.10.2.5.3	Selective RMS Measurement incl. Sweep .....	3.112
3.10.2.5.4	Peak and Quasi-Peak Measurement incl. S/N.....	3.119
3.10.2.5.5	DC Measurement .....	3.122
3.10.2.5.6	THD Measurement.....	3.123
3.10.2.5.7	THD + N / Sinad Measurement.....	3.125
3.10.2.5.8	MOD DIST .....	3.128
3.10.2.5.9	DFD .....	3.129

3.10.2.5.10	Wow & Flutter .....	3.130
3.10.2.5.11	POLARITY .....	3.131
3.10.2.5.12	FFT .....	3.131
3.10.2.5.13	Filter Simulation .....	3.136
3.10.2.5.14	WAVEFORM.....	3.137
3.10.2.5.15	Coherence Measurement and Transfer Function .....	3.140
3.10.2.5.16	Loudspeaker Measurements (RUB & BUZZ) .....	3.142
3.10.2.5.17	Input Level of Digital Signal (DIG INP AMP) .....	3.146
3.10.2.5.18	Phase Measurement (PHAS TO REF) .....	3.147
3.10.2.5.19	PROTOCOL.....	3.147
3.10.2.5.20	INPUT DISP .....	3.148
3.10.2.5.21	Frequency Measurement .....	3.150
3.10.2.5.22	Combined Frequency, Phase and Group-Delay Measurement .....	3.151
3.10.2.5.23	Sample Rate Measurement .....	3.154
3.10.2.5.24	Terzanalyse .....	3.156
3.10.2.5.25	12th Octave Analysis (12th OCTAVE) .....	3.160
3.10.3	Selection of Analyzer Filter .....	3.163
3.10.4	Units for IEC/IEEE Measurement Results .....	3.171
3.10.5	Loading and Storing.....	3.177
3.10.5.1	Loading and Storing Instrument Setups .....	3.177
3.10.5.1.1	Loading and Storing Traces and Lists .....	3.179
3.10.5.1.2	Storing Limit Violations (Error Reports) .....	3.180
3.10.5.1.3	Storing Equalization Files .....	3.181
3.10.5.2	Commands for Editing Files and Directories .....	3.182
3.10.6	Commands for Graphical Representation of Results .....	3.183
3.10.6.1	Commands for Limit Check .....	3.193
3.10.6.2	PROTOCOL Analysis .....	3.195
3.10.7	Commands for Printing/Plotting of Screen and Storing in Files.....	3.197
3.10.8	Setting and Display of Auxiliary Parameters .....	3.207
3.10.8.1	IEC/IEEE-Bus Address .....	3.207
3.10.8.2	Switching the Beeper On/Off .....	3.207
3.10.8.3	MACRO Operating .....	3.208
3.10.8.4	Transfer of Settings .....	3.209
3.10.8.6	Parameters of COM2 Interface .....	3.211
3.10.8.7	Keyboard Settings .....	3.212
3.10.8.8	Display Settings .....	3.213
3.10.8.9	Version Display.....	3.217
3.10.8.10	Calibration.....	3.219
3.10.8.11	Loading Speed f. Setups a. Analyzer Measurement Functions.....	3.220
3.10.9	Commands for Data Output .....	3.221
3.10.10	Commands for Input/Output of Block Data.....	3.222
3.10.11	Commands for Status and Error Queries .....	3.229
3.10.12	Commands for Synchronization .....	3.232
3.10.14	Settings without Corresponding IEC/IEEE-Bus Command .....	3.234

<b>3.11</b>	<b>Alphabetical List of IEC/IEEE-Bus Commands</b> .....	<b>3.235</b>
<b>3.12</b>	<b>IEC/IEEE-Bus Interface</b> .....	<b>3.293</b>
3.12.1	Interface Characteristics .....	3.293
3.12.2	Bus Lines .....	3.293
3.12.3	Interface Functions .....	3.294
<b>3.13</b>	<b>Interface Messages</b> .....	<b>3.295</b>
3.13.1	Common Commands.....	3.295
3.13.2	Addressed Commands .....	3.295
<b>3.14</b>	<b>List of Error Messages</b> .....	<b>3.296</b>
3.14.1	SCPI-Specific Error Messages .....	3.296
3.14.2	Command Error .....	3.297
3.14.3	Execution Error .....	3.298
3.14.4	Device-Specific Error .....	3.299
3.14.5	Query Error .....	3.299
3.14.6	UPL-Specific Error Messages.....	3.299
<b>3.15</b>	<b>Examples of IEC/IEEE-Bus Programming (Hints and Program Examples)</b> .....	<b>3.300</b>
3.15.1	R&S BASIC.....	3.300
3.15.2	IEC/IEEE-Bus Control after Power-Up .....	3.300
3.15.3	Command Logging - Converting UPL-B10 Commands into IEC/IEEE-Bus Commands.....	3.300
3.15.4	Initialization and Default Status.....	3.302
3.15.5	Sending Instrument Setting Commands.....	3.302
3.15.6	Switchover to Manual Control.....	3.302
3.15.7	Readout of Instrument Settings .....	3.302
3.15.8	Readout of Measurement Results .....	3.303
3.15.8.1	Readout of Triggered Measurements.....	3.304
3.15.8.2	Readout of Non-Triggered Measurements .....	3.305
3.15.9	Sweep Setting/Trigger .....	3.305
3.15.9.1	Generator Sweep.....	3.305
3.15.9.2	External Sweep.....	3.306
3.15.9.3	RMS-Selektiv-Sweep.....	3.306
3.15.10	Tuning - Setup for Maximum Measurement Speed.....	3.307
3.15.10.1	Configuration for Maximum Measurement Speed.....	3.307
3.15.10.2	Adapting Measurement Speed to Signal Frequency.....	3.307
3.15.10.3	Configuration for Maximum Sweep Speed.....	3.309
3.15.10.3.1	Generator Sweep .....	3.309
3.15.10.3.2	External Sweep .....	3.310
3.15.10.3.3	RMS Selective Sweep .....	3.310
3.15.10.3.4	Measurement Speed with Reference to Sampling Mode.....	3.312
3.15.11	List Management.....	3.312
3.15.11.1	Loading Lists into the UPL.....	3.312
3.15.11.1.1	Loading Sweep Lists into the UPL .....	3.312
3.15.11.1.2	Loading and Display of Several Traces in the UPL.....	3.312
3.15.11.1.3	Loading and Displaying of Trace Pairs in the UPL.....	3.313
3.15.11.2	Readout of Data Lists from the UPL.....	3.314
3.15.11.2.1	Readout of Lists of up to 1024 Values .....	3.315

3.15.11.2.2	Readout of FFT Lists of more than 1024 Values .....	3.315
3.15.11.2.3	FFT Lists with Suppressed Noise Floor .....	3.317
3.15.11.2.4	Readout of Several Traces from UPL .....	3.317
3.15.11.2.5	Readout of Trace Pairs from UPL .....	3.318
3.15.12	Filter Settings.....	3.319
3.15.13	Finding a File .....	3.320
3.15.14	Readout of Error Queue .....	3.320
3.15.15	Command Synchronization .....	3.320
3.15.15.1	Command Synchronization with *WAI.....	3.321
3.15.15.2	Command Synchronization with *OPC?.....	3.321
3.15.15.3	Command Synchronization with *OPC and SRQ .....	3.321
3.15.16	Service Request .....	3.322
3.15.16.1	SRQ Interrupt Routine with Serial Poll.....	3.322
3.15.16.1.1	Initialization of Serial Poll SRQ .....	3.322
3.15.16.1.2	Serial Poll SRQ Routine .....	3.323
3.15.16.2	SRQ Interrupt Routine with Parallel Poll.....	3.324
3.15.16.2.1	Initialization of Parallel Poll SRQ .....	3.324
3.15.16.2.2	Parallel Poll SRQ Routine .....	3.324
3.15.17	Readout of Cursor Position and Values .....	3.325
3.15.18	Call a BASIC-Macro.....	3.329
3.15.19	Third analysis - Output of Block Data .....	3.333
<b>3.16</b>	<b>Automatic Control of UPL with R&amp;S BASIC.....</b>	<b>3.337</b>
3.16.1	Use.....	3.337
3.16.2	Scope of Functions .....	3.337
3.16.3	Preparation for Use.....	3.338
3.16.4	Operation .....	3.339
3.16.4.1	Switchover between UPL and BASIC Entry Mode.....	3.339
3.16.4.2	First Steps (Readout of Measurement Results) .....	3.340
3.16.4.3	Logging Mode .....	3.340
3.16.4.4	Differences to IEC/IEEE-Bus Remote Control .....	3.341
3.16.4.5	UPL-Specific Modifications to the BASIC Manual .....	3.346
3.16.4.6	BASIC Screen.....	3.348
3.16.4.7	Control Commands Unsuitable for Logging .....	3.349
3.16.4.8	Driver for Screen and Keyboard STRINX.SYS.....	3.350
3.16.4.9	Operation of Serial Interfaces COM1 and COM2 .....	3.354
3.16.4.10	UPL-Specific Error Messages From BASIC .....	3.355
3.16.4.11	UPL/BASIC Memory Management.....	3.356
<b>3.17</b>	<b>Remote Control via RS-232 Interface .....</b>	<b>3.357</b>
3.17.1	Preparation for Use.....	3.357
3.17.2	Switchover to Remote Control .....	3.358
3.17.3	Return to Manual Operation.....	3.358
3.17.4	First Steps (Readout of Measurement Results) .....	3.358
3.17.4.1	Readout of Measurement Results in QuickBASIC .....	3.359
3.17.4.2	Readout of Measurement Results in R&S BASIC .....	3.360
3.17.4.3	Readout of Measurement Results in Borland-C 3.0 .....	3.361
3.17.5	Binary Data via RS232 Interface .....	3.363
3.17.6	Differences to Remote Control via IEC/IEEE Bus .....	3.364

---

<b>4</b>	<b>Maintenance and Troubleshooting .....</b>	<b>4.1</b>
<b>4.1</b>	<b>Maintenance.....</b>	<b>4.1</b>
4.1.1	Mechanical Maintenance.....	4.1
4.1.2	Electrical Maintenance .....	4.1
<b>4.2</b>	<b>Function Test .....</b>	<b>4.1</b>
<b>4.3</b>	<b>Troubleshooting .....</b>	<b>4.2</b>
4.3.1	BIOS-SETUP.....	4.2
4.3.2	Others.....	4.5
<b>5</b>	<b>UPL Default Setup</b>	
<b>A.1</b>	<b>Default Settings of Generator.....</b>	<b>A.1</b>
<b>A.2</b>	<b>Default Settings of Analyzer.....</b>	<b>A.13</b>
<b>A.3</b>	<b>Default Settings of Filter Panel .....</b>	<b>A.21</b>
<b>A.4</b>	<b>Default Settings of Display Panel .....</b>	<b>A.22</b>
<b>A.5</b>	<b>Default Settings of Options Panel.....</b>	<b>A.23</b>
<b>A.6</b>	<b>Default Settings of File Panel .....</b>	<b>A.25</b>
<b>6</b>	<b>Index</b>	







**ROHDE & SCHWARZ**  
EC Certificate of Conformity



Certificate No.: 9502140

This is to certify that:

Equipment type	Order No.	Designation
UPL	1078.2008.02/.05/.06	Audio Analyzer
UPL16	1078.2008.16	
UPL66	1078.2008.66	
UPL-B1	1078.4400.02	Low Distortion Generator
UPL-B2	1078.4000.02	Digital Audio I/O
UPL-B29	1078.5107.02	Digital Audio I/O 96 kHz
UPL-B5	1078.4600.02/.03	Monitoroutput

complies with the provisions of the Directive of the Council of the European Union on the approximation of the laws of the Member States

- relating to electrical equipment for use within defined voltage limits  
(73/23/EEC revised by 93/68/EEC)
- relating to electromagnetic compatibility  
(89/336/EEC revised by 91/263/EEC, 92/31/EEC, 93/68/EEC)

Conformity is proven by compliance with the following standards:

EN61010-1 : 1993 + A2 : 1995  
EN50081-1 : 1992  
EN50082-1 : 1992

Affixing the EC conformity mark as from 1995

**ROHDE & SCHWARZ GmbH & Co. KG**  
**Mühldorfstr. 15, D-81671 München**

Munich, 1999-03-04

Central Quality Management FS-QZ / Becker





# 1 Preparation for Use

## 1.1 Putting into Operation

### 1.1.1 Setting up the Audio Analyzer

The UPL can be operated in the following positions:

- Horizontal position: fold out the front feet provided on the instrument bottom in order to obtain a better view on the LC display.
- Vertical position tilted on its rear panel. Fold out the feet provided on the rear panel and use a 90° offset power connector (included in the accessories supplied).

**Note:** To ensure optimum performance of the audio analyzer observe the following:

- Do not cover the rear lateral ventilation openings.
- Adhere to the permissible ambient temperature specified in the data sheet.
- Avoid moisture condensation. If it has already occurred, dry out the instrument before switching it on.

### 1.1.2 Rackmounting

Use the adapter (see Data Sheet for type and order number.).

**Note:** To ensure optimum performance of the audio analyzer observe the following:

- Be sure sufficient air is supplied within the rack.
- There must be adequate space between ventilation openings and rack housing.

### 1.1.3 Power Supply

The UPL can be set to operate at AC supply voltages of **100 V**, **120 V**, **220 V** and **230 V** with a tolerance of  $\pm 10\%$  and a frequency of 47 Hz to 63 Hz. It can also be operated from AC supplies with other nominal voltages as shown in the table below.

Table 1-2 Operation of UPL from other AC supplies

Nominal AC supply voltage	Setting of voltage selector	Tolerance of instrument
110 V	100 V	+ 4 % – 18 %
	120 V	+ 20 % – 6 %
115 V	120 V	+ 15 % – 10 %
127 V	120 V	+ 4 % – 18 %
240 V	230 V	+ 6 % – 15 %

Before initial power-up, check that the correct supply voltage is set. If the setting is not correct, reset as follows:

- Remove power cable.
- Open cap of voltage selector using a slotted screwdriver.
- Remove both fuse holders and insert fuses of appropriate value (included in the accessories supplied):

Rated voltages 100 to 120 V,  
2 fuses T 4.0 H (IEC 127-2/III)

Rated voltages 220 to 240 V,  
2 fuses T 2.5 H (IEC 127-2/III)

- Insert fuse holder.

Remove the cylinder labeled with the rated voltages and re-insert it such that the value visible in the cap window when fitted corresponds to the desired rated voltage. If there is no suitable imprint, select the value closest to the desired one.

- Close the cap.

### 1.1.4 Switching On

**Note:** *Make sure no disk is available in the disk drive when turning the UPL ON (press ON/OFF switch on the front panel).*

Switch-on of the UPL is followed by the system start-up, selftest of the controller and loading of the MS-DOS operating system as well as of the measurement and operating software from the hard disk. While the UPL switch-on logo is being displayed, the selftest of the measurement hardware is executed (see Section 4.2 Function Test). The last UPL setup which has been automatically stored is subsequently loaded from the CMOS-RAM, setting the UPL to the status valid before switch-off.

**Note:** *If no characters are displayed on the screen after switch-on, the contrast control may be maladjusted (UPL02 with monochrome display only). Press the "Contrast" key in the CONTROL field of the front panel keypad and set the contrast for the desired angle of view using the rotary knob.*

For operation of an external monitor, refer to Section 2.17, Connecting External Devices.

**Note:**

- The system selftest also includes checking the availability of an external keyboard (see 2.17 Connecting External Devices). If an external keyboard is connected, it can be used for operating the UPL.
- Connecting the external keyboard after having turned on the UPL may involve that the software does not recognize the keyboard i.e. it is without function.
- With the use of an external keyboard, the storage test of the system can be aborted - while the storage addresses are being counted up - using the ESC key.
- The system messages output during system start-up are not displayed, since the LC display is not yet ready at this time. To make these messages visible, which is usually not required, it is necessary to connect an external monitor.

- The message

PRESS <DEL> IF YOU WANT TO RUN SETUP/EXTD-SET

or any corresponding message is displayed during system start-up (on an external monitor, only). Pressing this key allows you to enter the SETUP program where system configuration, date and time can be defined. We advise against calling this program as changing its settings, though inadvertently, may cause the UPL to work incorrectly or not work at all.

Calling this program is required only after battery replacement. (Section 4.3 Troubleshooting, deals with battery replacement and setups and, in addition, how to correct a maladjusted SETUP.) If required, date or time should be changed using the DOS commands DATE and TIME.

### 1.1.5 Switching Off

- Wait until there are no accesses to the hard disk or disk drive anymore.
- Remove the disk from the drive.
- Press the ON/OFF key on the front panel. (All UPL setups are maintained.)

### 1.1.6 Connecting an External Keyboard

**Note:** *Connect the keyboard only with instrument switched off. Otherwise, correct function of the keyboard cannot be guaranteed.*

The keyboard connector is fitted to the rear of the instrument (KEYBOARD label). Any standard PC keyboard may be used.

In normal operation, the keyboard facilitates the entry of commentary texts, file names etc. If the controller mode of the UPL is selected, e. g., in order to store measurement results in documents, the keyboard assumes its usual PC function (cf. **2.18 UPL Used as Computer**).

Section 2.1.1 (Front View of the Instrument) includes an overview of the assignment of the key functions of the UPL front panel to short-key combinations of the external keyboard. This assignment table can be looked up at any time in the help function (press front panel key HELP or F1 on the ext. keyboard) under the key-word "UPL".

The automatic repetition rate with constant key stroke and the associated delay can be modified in the OPTIONS panel (Rep rate, Rep delay).

Either a keyboard with German or English key assignment can be selected:

- change to DOS (press SYSTEM key)
- call "BOOTSET" program and make appropriate selection
- enter UPL to return to measuring operation

### 1.1.7 Connecting a Mouse

**Note:**

Connect the mouse only with the instrument switched off. Otherwise, correct operation cannot be guaranteed.

The complete UPL may be mouse-controlled. Particularly, the entry of commentary texts, file names etc. is easier than via the front panel keys, only (selecting the keys of a "screen keypad"). Mouse control is described in Section 2.3.

The UPL requires the appropriate mouse driver in the path C:\MOUSE of the UPL named mouse.com., which must be available on a 3.5"-disk.

Proceed as follows:

(In the subsequent example, the mouse driver to be installed is called msmouse.com and is located in the root directory of the disk)

- Connect external keyboard. Connect mouse to the interface COM1 and switch on the instrument
- Press ESC while the UPL switch-on logo is displayed to change to the DOS level
- Insert the disk with the driver to be installed in the 3.5" drive.
- Execute the following DOS command: `copy a:msmouse.com c:\mouse\mouse.com`
- Enter UPL: the UPL operator surface is started.

## 1.2 Fitting Options

### Installation of hardware options:

Hardware options may be installed only by a Rohde & Schwarz service center.

### Installation of software options:

- Either manual entry of installation key (see 1.2.1) or
- installation of supplementary software by means of a installation program supplied with automatic enabling of option (see 1.2.2 Installation of Supplementary Software).

Which of the two methods is used depends on the option concerned and is described in the installation instructions enclosed.

To order the following options, the serial number (SER. xxxxxx/xxx) at the rear of the unit has to be entered; the material number (1078.2008Kxx) is additionally required for newer units (SER. xxxxxx).

• Digital Audio Protocol	UPL-B21	1078.3856.02	(manual enabling)
• Jitter and Interface Test	UPL-B22	1078.3956.02	(manual enabling)
• Remote Control	UPL-B4	1078.3804.02	(manual enabling)
• Extended Analysis Functions	UPL-B6	1078.4500.02	(manual enabling)
• Universal Sequence Controller	UPL-B10	1078.3904.02	(manual enabling)
• Line Measurement to ITU-T O.33	UPL-B33	1078.4852.02	(manual enabling)
• Coded Audio Signal Generation	UPL-B23	1078.5188.02	(automatic installation)
• Mobile Phone Test Set	UPL-B8	1117.3505.02	(automatic installation)
• 3G Mobile Phone Tests	UPL-B9	1154.7500.02	(automatic installation)

### 1.2.1 Enabling Software Options

If one of the options was uninstalled by mistake, it has to be installed again, which is explained in the following, the **Remote Control UPL-B4** being used as an example.

- Switch on unit.
- Select the OPTIONS panel by means of the OPTIONS key on the UPL front panel or by pressing the ALT+O keys on the external keyboard and scroll to the panel end by means of the Cursor or Page key.
- Enter the numbers printed on the adhesive label at the rear of the unit into the **Option No.** and **InstallKey** fields in the OPTIONS panel.

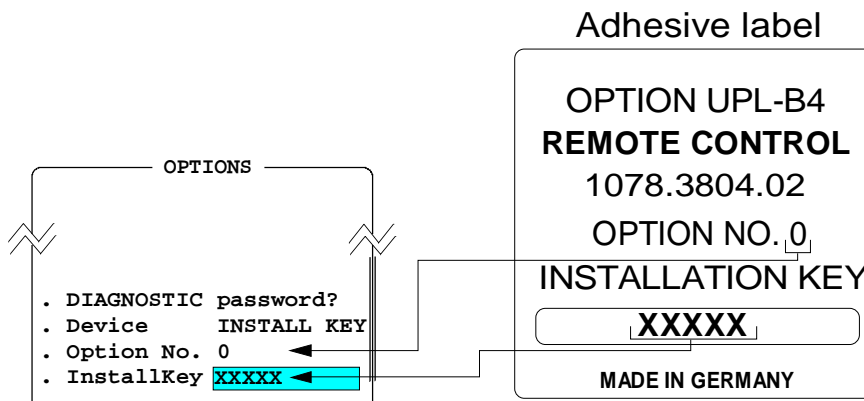



If the correct installation key has been entered, the following message is displayed:

Option installed!

If a wrong installation key has been entered, the following message is displayed:

Wrong Installation Key!  
Turn power off and restart UPL!

After the UPL has been switched off and on again, the installation key can be entered a second time.

If the installation key is entered again without having switched off/on the UPL beforehand, the following message is displayed:

To retype Installation Key,  
turn power off and restart UPL!

## 1.2.2 Installation of Supplementary Software

A software option for which supplementary software is required in addition to the installation key is installed via an installation program supplied. This program checks whether the option is enabled and queries the installation key, if necessary. If an already enabled option is installed (for the first time), this query will be omitted.

For first-time installation of option software, proceed as follows:

- Switch off unit (so that keyboard will be recognized correctly afterwards).
- Connect external keyboard.
- Switch on unit.
- Quit the UPL operating software either
  - by pressing the ESC key (or CANCEL key of the UPL keyboard) while the start-up logo is being displayed or
  - (while the UPL operating software is running) by pressing the SYSTEM and ENTER keys (corresponds to "Normal Exit to DOS" in the selection box).

Perform all subsequent entries via the external keyboard.

- Insert floppy #1 of option software.
- Enter "A:" and confirm entry using the Return key.
- Enter name of installation program according to installation instructions (e.g. PHONINST for UPL-B8, B23INST for UPL-B23) and confirm entry using the Return key.
- Enter the installation key supplied when prompted to do so (only for first-time installation).

**Note:** *If the entry via the external keyboard is not possible, the Universal Sequence Controller had been selected after power-up of the UPL. In this case, the UPL has to be switched off and the installation has to be started again. The selection of "Universal Sequence Controller" has to be avoided.*

- Continue installation according to instructions displayed. Normally, the only action required is to insert and remove floppies.
- If the software consists of several floppies, make sure that the floppies are inserted in the correct order (start with floppy #1).

**Note:** *The software is supplied on the floppies in compressed form and is unpacked only during installation (the size of the unpacked software is therefore much larger than the capacity of the floppy). The program for unpacking the software may output messages like "Exploding...", "Unpack" etc. These messages are correct. They do not indicate an erroneous installation.*

### 1.2.3 Installation of Virtual Drive (RAMDRIVE)

If the UPL has sufficient RAM capacity (at least 16 Mbyte), part of the RAM can be used as a RAM drive. Like normal hard disk drives, this virtual drive can be accessed via a drive letter (normally D:). Data on the RAM drive can be processed much faster than data on the hard disk but is no longer available if the UPL has been switched off. Therefore, the user has to make sure that RAM drive data is saved (on floppy or hard disk) - unless it is to be used only temporarily - prior to switching off the unit.

The RAM drive can be easily activated by means of the UPL software (version 3.0 or higher). In the CONFIG.SYS (available in the UPL root directory) the corresponding line is marked with REM which means that the line cannot be executed. To activate the RAM drive, delete the keyword REM in the following line:

```
REM DEVICEhigh =c:\dos\RAMDRIVE.SYS 17000 /E
```

Then install the UPL software (PROGRAM floppy) 3.0 or higher again to ensure that this modification is implemented in all other relevant files.

If a RAM drive is to be installed in an **UPL software version 1.xx or 2.xx**, the following has to be observed:

- The line mentioned above must be entered in *all* CONFIG.\* files (in the root directory of the UPL); otherwise this entry will be lost upon reconfiguration (with UPLSET.BAT).
- These entries are lost when the software is updated to version 1.xx or 2.xx.

If **less than 32 Mbyte RAM** is installed in the UPL, the RAM drive capacity should be selected so that at least 4 Mbyte or better 8 Mbyte RAM is available for the UPL:

- With **16 Mbyte RAM** a smaller RAM drive of max. 8 Mbyte is to be generated. The numeric value 17000 (17 Mbyte) in the above line then has to be reduced to 8000.
- With **8 Mbyte RAM** a RAM drive should not be used. If the ARBITRARY generator function is not used to play CPR, ACC or WAV files, a small RAM drive of max. 4 Mbyte may be used.
- With **4 Mbyte RAM** no RAM drive can be installed.

**Notes:**

- *It is strongly recommended to install a RAM drive for the option UPL-B23. The RAM drive is installed if the installation is performed in the factory.*
- *To operate the option UPL-B23 (Coded Audio Signal Generation) with **8 or 4 Mbyte RAM**, it is recommended to start the UPL with the call parameter '-ramdriveC'. Thus, the UPL knows that it has to use a hard disk directory to buffer the files. Since there is only a subset of library files in this directory, download times are considerably reduced.*
- DOS automatically assigns a drive letter to the RAM drive. In the UPL, this is normally drive D:. If a different drive letter (e.g. X:) is used due to a special configuration of the UPL, this letter should be communicated to the UPL software (from version 3.0 or higher) via the call parameter '-ramdriveX' with X being the designation of the RAM drive.

## 1.3 Software Installation

The following floppy disks are supplied together with the UPL:

- MS-DOS system floppies, containing all programs associated with MS-DOS.
- UPL program floppies, including the complete UPL operating and measurement software.
- UPL Example Disk. It contains examples for remote control via IEC/IEEE-bus and for Universal Sequence Control UPL-B10. as well as setups to different measurement applications.

The UPL is supplied with the operating system and the UPL software including example files already installed on the built-in hard disk. The supplied floppy disks are needed only when the complete software or parts thereof have been deleted inadvertently by the user. The MS-DOS, UPL software and example files can also be installed separately.

**Note:** *The UPL software is supplied in packed format and unpacked only during installation (the software then considerably exceeds the capacity available on the disk). The unpacking program may output messages such as "Exploding...", "Unpacking" etc. These messages are correct and do not mean faulty installation.*

### Installing the MS-DOS operating system:

- Connect the external keyboard.
- Switch on UPL, insert 1st disk.
- Press CTRL + ALT + DEL (or STRG+ ALT+ ENTF) keys.
- The installation program is started.

Continue the installation following the notes on the screen.

### Installing the UPL operating and measurement software:

- Connect the external keyboard.
- Switch on UPL.
- Exit the UPL operating software by pressing ESC key while the switch-on logo is being displayed on the screen, or, with the UPL operating software loaded, by pressing the SYSTEM key and Enter (corresponds to "Normal Exit to DOS" in the selection box).
- Insert the UPL program disk.
- Key in A :, press Enter.
- Key in UPLINST, press Enter.

The UPL software is now copied onto the hard disk.  
Continue the installation following the notes on the screen.

The UPL user interface is be displayed on the LCD screen.

**Note:** *If an updated version of the UPL software is to be installed, proceed as described above.*

**Installation of UPL example files:**

- Connect the external keyboard.
- Switch on UPL.
- Exit the UPL operating software by pressing ESC key while the switch-on logo is being displayed on the screen, or, with the UPL operating software loaded, by pressing the SYSTEM key and Enter (corresponds to "Normal Exit to DOS" in the selection box).
- Insert the UPL example disk.
- Key in A :, press Enter.
- Key in SETINST, press Enter.

The UPL example files are now copied onto the hard disk. Then the UPL operating software can be started as usual.

The files copied onto the hard disk during installation are stored in the following directory structure:

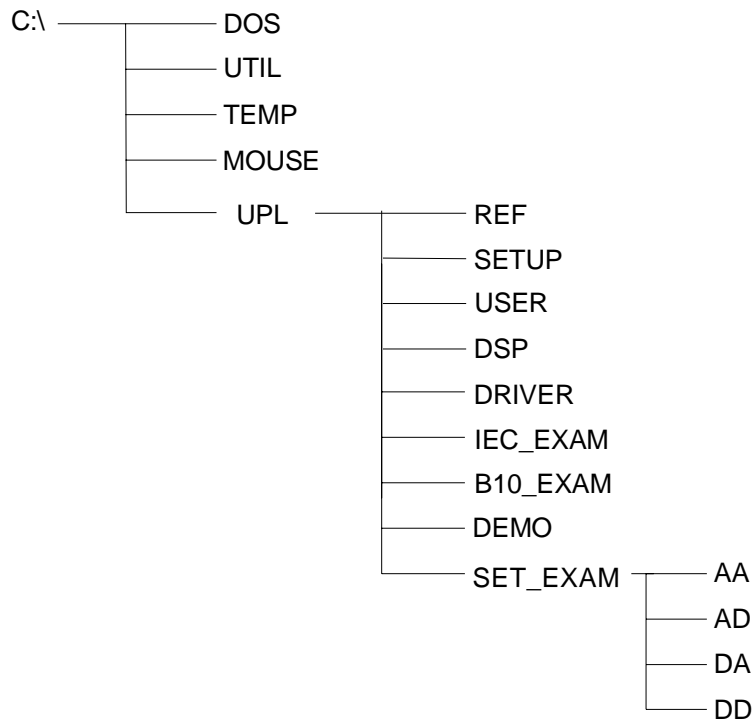

The READ.ME file in the C:\ directory refers to the contents of the individual directories and files.

After installation, the \DOS, \UTIL and \UPL paths are defined.

**Note:** To ensure correct functioning of the UPL measurement and operating software, do not modify the directory structure stated above nor the paths.

## 1.4 UPL Start Options

This chapter is primarily for advanced users since basic knowledge of the MSDOS operating system is required, thus allowing the user to additionally optimize the UPL for special applications.

### 1.4.1 Restarting the UPL Software

The software is automatically started when the UPL is switched on. A restart of the UPL software is normally not required but may be performed any time. There are different possibilities to do this:

1. *If an external keyboard* is not provided, the UPL has to be switched off and on again by means of the power switch (cold booting). Wait at least 10 s before switching the UPL on again to prevent the hard disk from being damaged.
2. *If an external keyboard* is provided, the UPL can be restarted by pressing the keys Ctrl + Alt + Del (warm booting). This is much faster than method 1.
3. The UPL software can be quit via the SYSTEM key (Ctrl F9 on external keyboard). The UPL is then at operating system level which is shown by the DOS prompt "C:path name>". The path name indicates the current directory. The UPL software can be restarted at this level by entering "upl" and then pressing the Enter key. This is even faster than the warm booting method described above.

### 1.4.2 Integration of Supplementary Programs

It may be desirable for certain applications to install supplementary programs on the UPL and to start them upon power-up prior to starting the UPL software. Such supplementary programs can be hardware drivers (e.g. mouse drivers, keyboard drivers for special external keyboards) but also batch files or programs for special applications.

Usually, such programs are entered in the AUTOEXEC.BAT file. This is, however, not a solution recommended for the UPL since the AUTOEXEC.BAT file is overwritten whenever the software is installed (e.g. during a software update) and when the configuration program BOOTSET is called up.

Instead, all additional applications should be called up in the batch file USERKEYB.BAT. This file – if not yet available – is generated in the UPL root directory (C:\UPL) together with a USERKEYB.DEF sample file during the installation of the UPL software (version 3.0 or higher) and then comprises examples of lines for potential applications. These lines cannot be executed since they are preceded by the keyword REM.

Like any other batch file, USERKEYB.BAT can be processed by a text editor (e.g. EDIT) and adapted to user requirements:

- A program line is activated by deleting the keyword REM at the beginning of the line.
- A program line is deactivated by inserting the keyword REM at the beginning of the line or by deleting the whole line.
- The whole batch file is deactivated by renaming (e.g. USERKEYB.SAV) or by deleting it.

USERKEYB.BAT must be located in the UPL root directory where it is called up while AUTOEXEC.BAT is being executed.

USERKEYB.BAT is exclusively checked by the user and is neither modified by the UPL software nor by installation programs.

Like AUTOEXEC.BAT, USERKEYB.BAT is executed only once when the internal controller is (re)started. Calling "upl" from the operating system level (see 1.4.1) does *not* execute the two batch files.

### 1.4.3 Command Line Parameters of the UPL Software

The (start) behaviour of the UPL can be individualized by means of command line parameters. Moreover, particular command line parameters, called 't-switches', allow the UPL to be configured for very special functions that are not documented in the manual.

If the UPL is called up using an invalid parameter, a list of valid parameters is displayed and the program is terminated.

Some of the command line parameters of the UPL are described in the following. Other parameters, especially those beginning with "-t" should be selected by the user only if the function is exactly known since the UPL's behaviour can, as a consequence, deviate more or less from the usual and described functionality.

The complete list with all command line parameters is displayed on the UPL when the UPL software is called using the parameter "-t?".

#### **Display settings:**

Command line parameter	Value	Description
-c		Coloured display on LCD <i>and</i> external monitor.
-m		Monochrome display on LCD <i>and</i> external monitor.
i		Monochrome display on LCD, only; external monitor is <i>not</i> addressed.

#### **Used setup:**

Command line parameter	Value	Description
-d		The UPL always starts with the default setting.
-sfilename.xxx		The UPL always starts with the setting of the given setup "filename.xxx". "filename.xxx" must be a "complete" setup.

#### **Configuration of universal sequence controller (BASIC options):**

Command line parameter	Value	Description
-bpx		Explicit indication of BASIC program memory capacity in kbyte. Permissible values for x: 8 to 64; the default setting is 32 or 64 kbyte depending on the configuration selected.
-bdx		Explicit indication of BASIC data memory capacity in kbyte. Permissible values for x: 4 to 0.64; the default setting is 32 or 64 kbyte depending on the configuration selected.
-bnfilename		BASIC program (macro) to be loaded and started automatically upon program start.
-r		Suppresses the waiting interval for user entries while the UPL is being started. Thus, the UPL can be started much more quickly. This parameter is also recommended when the UPL is remote-controlled.

**Other:**

Command line parameter	Value	Description
-ax		Analyzer options:
	x=1	When the analog channels are switched off, the outputs are switched to high impedance (high Z).
-ox		Parameter to ensure compatibility with previous software versions:
	x=1	Digital FS is <i>not</i> dealt with according to AES-17 standard: a sine signal with the amplitude 1 FS yields an RMS value of 0.7071 FS. A squarewave signal with the amplitude 1 FS yields an RMS value of 1.0 FS.
	x=2	During S/N measurements, the wanted signal is also measured using the selected filters.
	x=4	Waveform can be represented on a logarithmic scale.
	x=5	Modification of rollkey function in the operating panels: The rollkey cannot be used for navigating in the panel. Instead, it opens the selection window at the cursor position in the panel.
	x=14	Protocol data is no longer updated when switching over to PROTOCOL PANEL OFF (default behaviour prior to version 3.0).
	x=15	Use of previous jitter weighting filter (prior to version 3.0).
-ramdriveX		Definition of drive X as (pseudo) RAM drive.
	X=D	Default state; drive D: is used as RAM drive.
	X=C	A temporary directory on the hard disk is used as pseudo RAM drive. This is recommended if not enough RAM memory capacity is available to install a RAM drive and the UPL-B23 option is used.
	X=E or higher	The RAM drive used by the UPL-B23 option is drive E: (or higher); it is recommended if other drives or RAM drives are installed in the UPL.

**Hidden command line parameters:**

Command line parameter	Value	Description
-tsk		PCX pictures are printed using the softkeys.
-tjit		Jitter mode is selectable (clock or data jitter).
-tdcx	x=h	The optional Audio Monitor is reconfigured to operate as DC output. Voltage range -6 V to +6V.
	x=l	DC voltage range of reconfigured Audio Monitor: -2 V to +2 V.
-tsyncx		Behaviour in case of "lock error" (default: no reset, but restart of measurement).
	x=1	No reset but measurement is continued.
	x=2	No check for "lock error" in digital analyzer.
	x=3	Reset of AES receiver; measurement is restarted (default behaviour prior to version 3.0).
-tlog		Activates logging of IEC/IEEE-bus commands as BASIC commands. This allows to find out (with UPL-B10 installed) which IEC/IEEE-bus commands were sent from the host processor to the UPL.
-trest		Prevents the ongoing measurement to be restarted with generator frequency and level settings.
-tfilxz.yz		Rub & buzz measurement: modifies the waiting time for filter settling:
	xz	xz: divides the settling time of an optional lowpass filter by x.z.
	yz	yz: divides the settling time of the standard tracking highpass filter by y.z.
	Examples	99 reduces the settling time by a factor of $1/9.9 = 0.101$ . 10 leaves the settling time unchanged.

Command line parameter	Value	Description
		04 increases the settling time by a factor of $1/0.4 = 2.5$ .
-ttimo		Deactivates the timeout test for measurements.
-tthdnwin		THD+N measurement: window for FFT is settable.
-tpanel		Automatically generates a text file of the same name (TXT file) with the contents of all panels when an actual setup (SAC files) is stored.
-tterz.x.y	x.y = 0.1 to 9.9	Third-octave analysis: sets the decay time constant (in seconds) for the Maxhold function. (Example: -tterz0.1 sets 0.1s).
-twavx		ARBITRARY generator function: selects the channel of WAV files to be played (default: stereo is played in mono).
	x = 0	Left mono channel.
	x = 1	Right mono channel.
	x = 2	Stereo (only possible in digital generator with 8-bit signals).
-tpolarx	x > 0	Rub & buzz measurement: determines the measurement time of the polarity measurement in $\mu\text{s}$ (-tpolar200 sets a measurement time of 0.2 ms).
-tquot		Allows the vertical line ( ) instead of the inverted comma (') in IEC/IEEE-bus commands.
-tappl		Causes the "Working Dir" of the application setups to remain unchanged even in the event of loading from the application level and protects it from being overwritten by the current working directory. This facilitates application setup adaptation with subsequent storage at the same location.
-tkeyb		Allows the connection of an external keyboard even after UPL power-up. Deactivates the virtual keyboard. An external keyboard <i>must</i> be connected to enter letters.
-tsinad		SINAD/THD+N measurement: the weighting filter also has an effect on the RMS measurement result.
-tanlg		Allows the FFT representation in the 110 kHz analyzer up to 140 kHz; typical level error above 120 kHz: approx. 3 dB.

#### 1.4.4 Immediate Effect of Command line Parameters at Power-Up

If command line parameters are to be effective every time the UPL is started, it is desirable to enter them as fixed data. The method of writing them into the AUTOEXEC.BAT – as described in Section 1.4.2 Starting Supplementary Programs – is not a useful long-term solution.

The USERKEYB.BAT file is also suitable for this application. The DOS variable UPLCFG can be defined with the desired list of arguments which is then transferred to the UPL program. The correct syntax is as follows:

```
set UPLCFG=lists of arguments
```

The "list of arguments" contains all desired command line parameters separated by blanks.

Example:

```
set UPLCFG=-r -d
```

The UPL is always started in the default setting (-d) without waiting for any keystroke (-r).





## 2 Manual Operation

**Note:** You do not need any specific knowledge as to the MS-DOS operating system for use of the UPL.

We assume that you know what is meant by e.g. a file, a directory or a path and do not provide any further explanations on that.

### Legend of graphic symbols used in this manual:

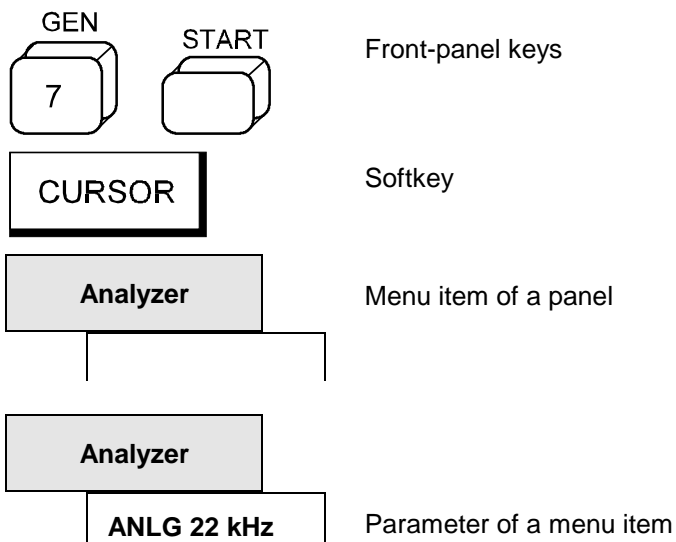

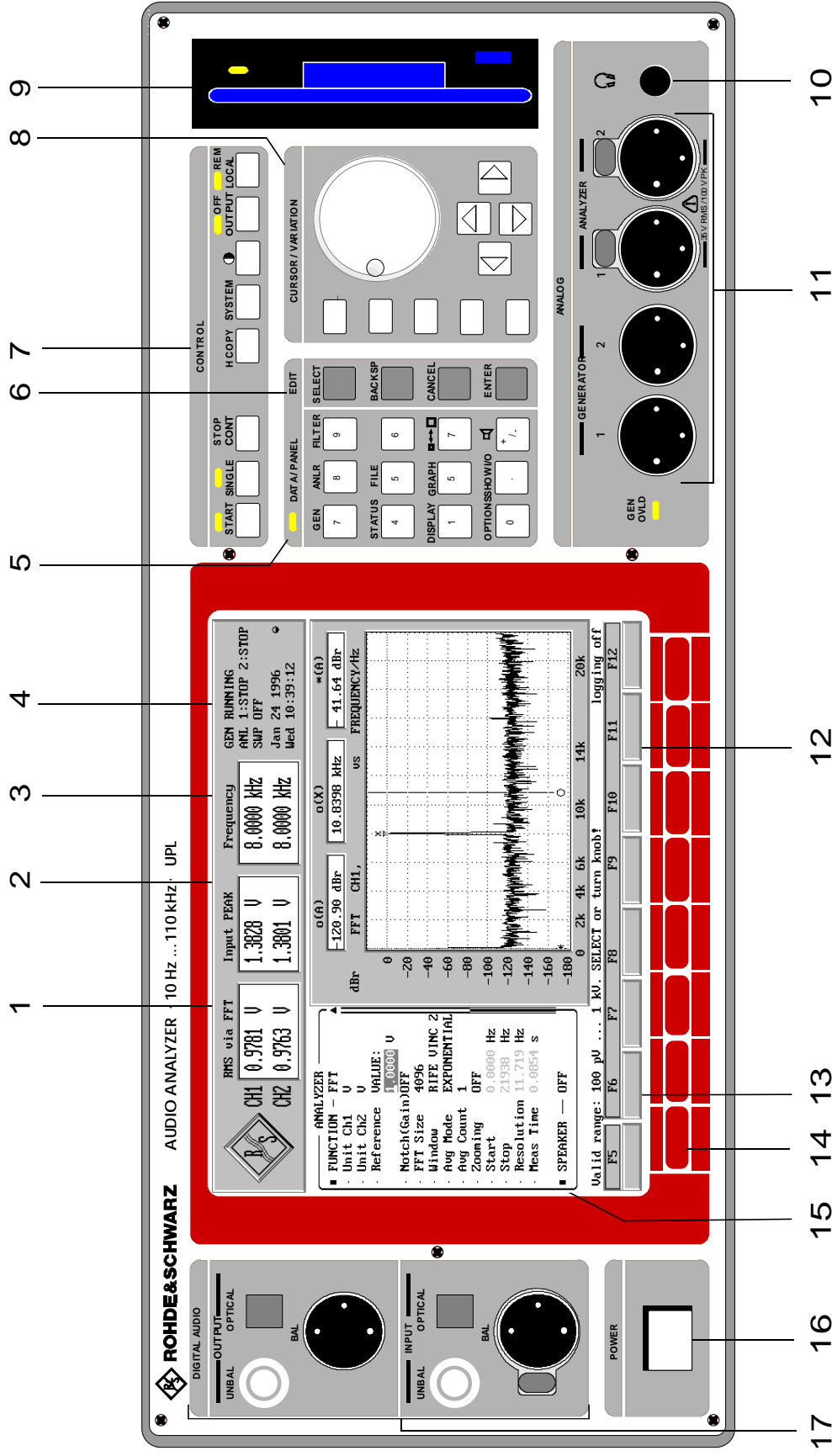

Fig. 2-1 Front-view

## 2.1 Explanations of Front- and Rearpanel Views incl. Key Combinations on the External Keyboard

### 2.1.1 Front-panel View

**1**

Display of the result of a selected measurement function, simultaneously for channel 1 and 2

**2**

Display of a second measured value per channel, e.g., peak level of input signal, simultaneously for channel 1 and 2

**3**

Display of frequency for both input signals or of frequency and phase between both input signals



**4**

Current mode of generator, analyzer and sweep system. Date and time.

### **5 DATA / PANEL**

Keypad with dual assignment:

DATA-LED ON: Keys serve as numeric keypad ( $\pm$  key switches the sign over)  
 DATA-LED OFF: Keys are used to call a panel (see 2.3.1 Panels); the labeling above the keys is valid:

Front-panel key	Key combination	Function
	External keyboard	
<b>GEN</b>	Alt G	Settings of all generators (see 2.5 Generators (GENERATOR Panel))
<b>ANLR</b>	Alt A	Settings of all analyzers (see 2.6 Analyzer PANEL)
<b>FILTER</b>	Alt T	Filter definitions of analyzers (see 2.7 Analyzer Filters (FILTER Panel))
<b>STATUS</b>	Alt S	Sum up user-definable menu items of any panel (see 2.8 STATUS Panel)
<b>FILE</b>	Alt F	Loading and storing traces and lists (see 2.9.1), editing files and directories (see 2.9.2)
<b>DISPLAY</b>	Alt D	Parameters for graphical display of results (see 2.10 Graphical Data Presentation)
<b>GRAPH</b>	Alt R	Activate panel or graphical display (toggle function)
 	ALT Z	Switch between full-screen and part-screen mode (toggle function) (see 2.10.9)

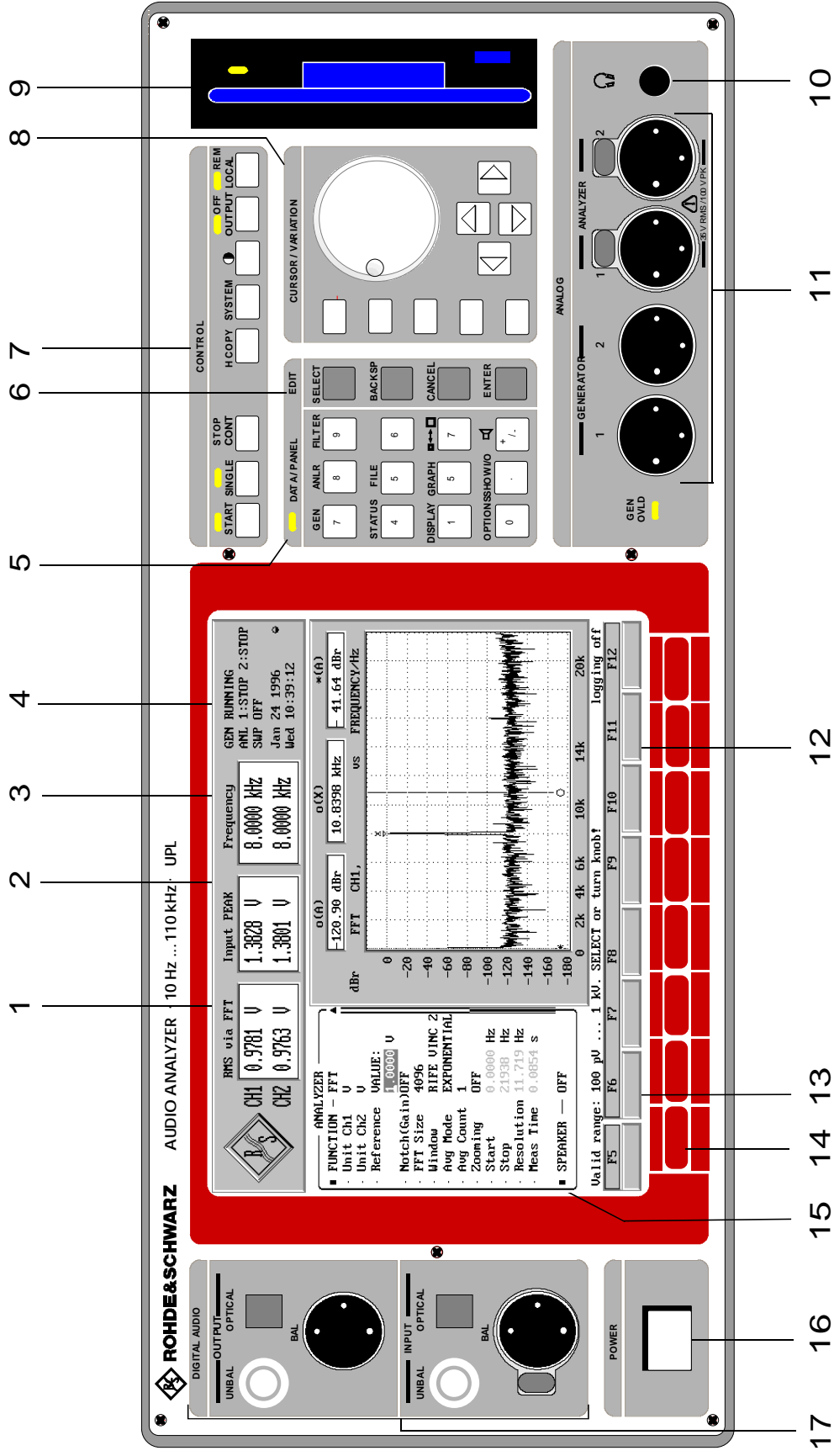

Fig. 2-1 Front-view

1078.2008.02

2.4

E-10

**5 DATA / PANEL**

Keypad with dual assignment:

DATA-LED ON: Keys serve as numeric keypad ( $\pm$  key switches the sign over)  
 DATA-LED OFF: Keys are used to call a panel (see 2.3.1 Panels); the labeling above the keys is valid:

<b>OPTIONS</b>	Alt O	Parameters for printout (see 2.14 Printing/ Plotting) and auxiliary settings (see 2.15 Setting and Displaying Auxiliary Parameters)
<b>SHOW I/O</b>	Alt I	Front-panel display with the selected inputs/ outputs marked; explanations in the case of indistinct input signals

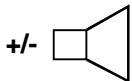

Open a box for setting the monitoring volume if the Option UPL-B5 (Monitor Output) is installed.

**6 EDIT keypad**

(see 2.3.2 Data Entry)

<b>SELECT</b>	Space	Open a selection, input or dialog window, selects characters in the entry box for entering text without external keyboard
<b>BACKSP</b>	*	Delete the character before the cursor
<b>CANCEL</b>	Esc	Close open window, the old value or parameter will remain effective
<b>ENTER</b>	Enter	Close open window, the new value or parameter will be accepted

**7 CONTROL keypad**

<b>START</b>	Ctrl F5/ Strg F5	Starts continuous measurement or sweeps. ( $\rightarrow$ LED lights up).  Resets min. and max. values of bargraph display, average values and average traces (see 2.11 Starting and Stopping of Measurements or Sweeps)
<b>SINGLE</b>	Ctrl F6/ Strg F6	Starts a single measurement or single sweep. LED lights during a single sweep (see 2.11 Starting and Stopping of Measurements or Sweeps)
<b>STOP/CONT</b>	Ctrl F7/ Strg F7	Stops or continues measurement or sweep (toggle function) (see 2.11 Starting and Stopping of Measurements or Sweeps)
<b>H COPY</b>	Ctrl F8/ Strg F8	Prints a hard copy of screen (see 2.14.1 Screen copy to printer (pixel-oriented))
<b>SYSTEM</b>	Ctrl F9/ Strg F9	Return to MS-DOS (see 2.18 UPL Used as Computer)

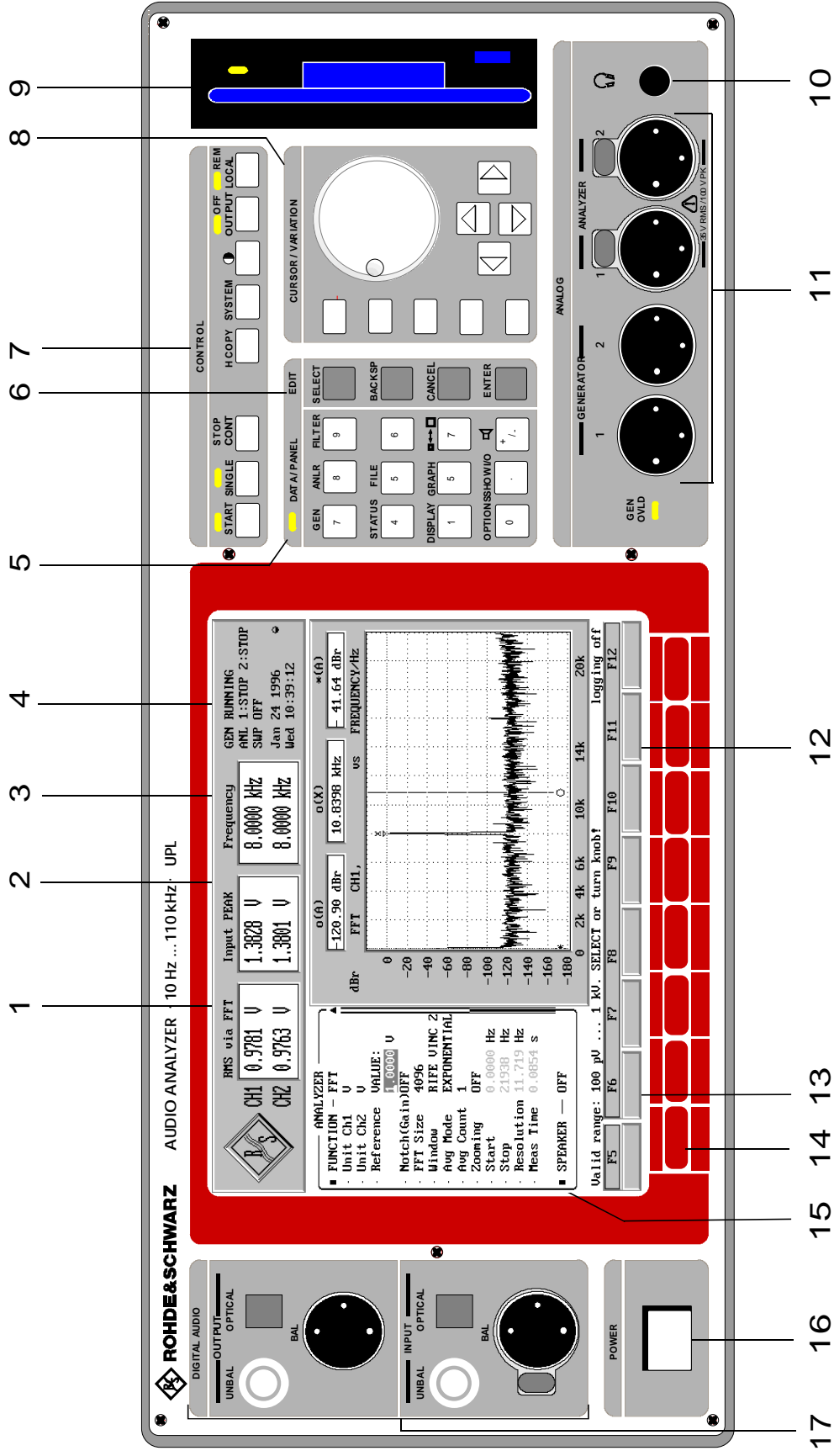

Fig. 2-1 Front-view

1078.2008.02

2.6

E-10

**7 CONTROL keypad**

●	Ctrl F10/ Strg F10	Open window for setting the contrast of the LCD via rotary knob.
<b>OUTPUT</b>	Ctrl F11/ Strg F11	Switches all outputs ON/OFF (OFF: LED lights up) (see 2.13 Fast Switch-off of Outputs)
<b>LOCAL</b>	Ctrl F12/ Strg F12	Switch from remote to local mode (Remote control: LED is ON) In LOCAL mode, the internal loudspeaker and, optionally, the connected headphones are switched on/off if the option UPL-B5 (Monitor Output) is installed.



(Speaker off)

**8 CURSOR / VARIATION keypad**

(see 2.3.2 Data Entry, 2.3.1 Panels)

<b>HELP</b>	F1	Opens a help window
→ , *	→ , *	Tabulator right/left; change to the next input field to the right or to the left, may be used also for toggling between input panel and graphical window
<b>PAGE*, PAGE*</b>	Page *, Page * Picture*, Picture *	Turn pages in a panel or move windows back and forth If the graphical window is activated (by means of the GRAPH key or Alt R, and discernible from the softkeys being labeled with the graphics control functions), the PAGE keys are used to scroll up or down the scan index (see 2.9.3.3, Scans count >1).
*, *	*, *	Move the cursor up/down
→, *	→, *	Move the cursor to the left, right; only effective in an open input window. In the graphical window, too, the cursor position is changed unless MANUAL SWEEP is selected. With MANUAL SWEEP (started by means of the START key), the sweep steps are advanced by means of the horizontal cursor keys. When the STOP key is pressed, switchover is made back to the graphics cursors. In manual sweeps, the rotary knob has the same function as the horizontal cursor keys.
<b>Rotary knob</b>	Cntrl * / Strg * Cntrl → / Strg →	Increment or decrement the number on the cursor position, move the active cursor in the graphical display

**9**

3.5" disk drive, LED indicates a read or write access

**10**

Headphones connector (Option UPL-B5)



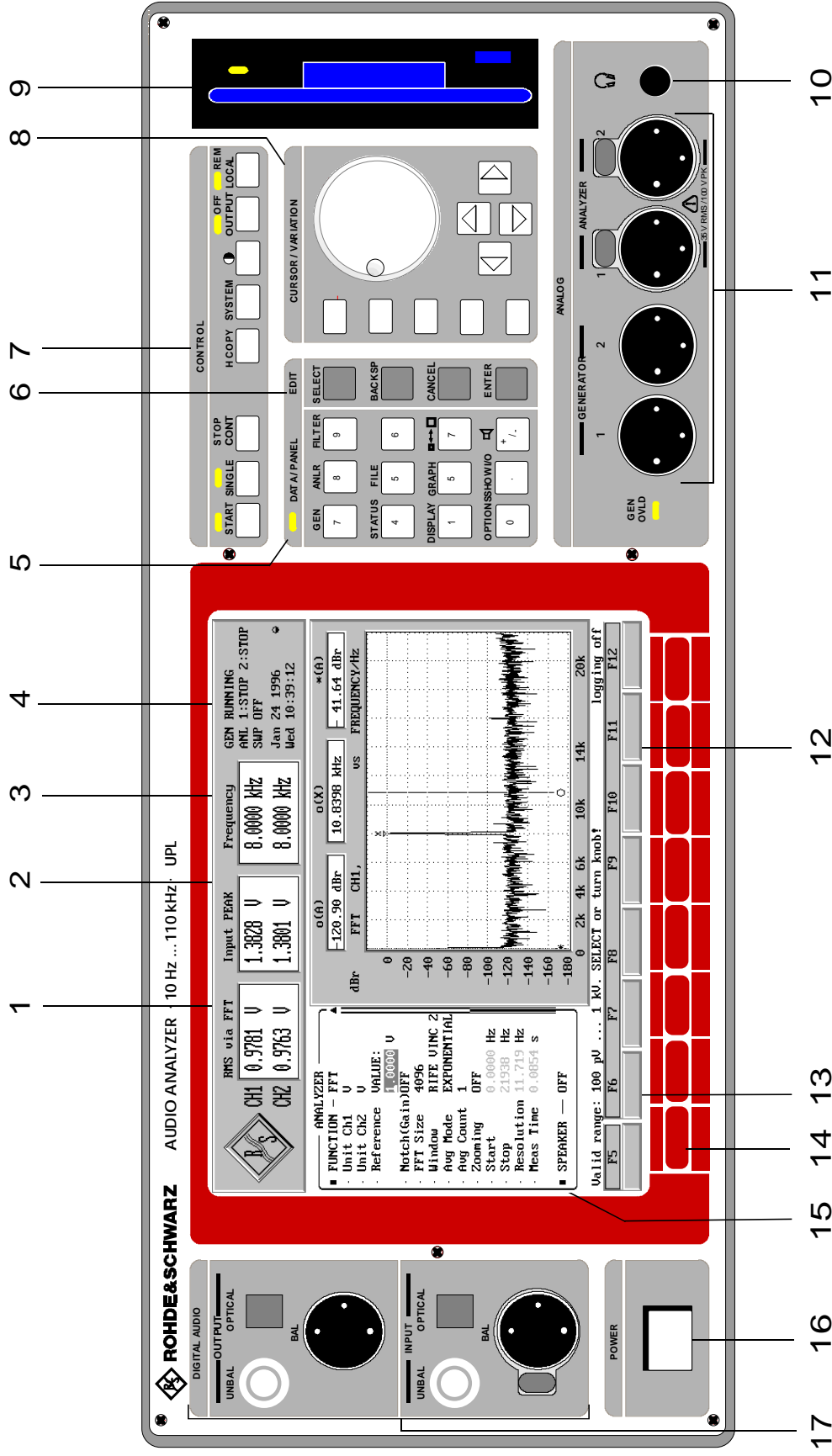

Fig. 2-1 Front view

**11**

Input and output connectors of the analyzers and generator for the analog interfaces (see 2.5.2 Configuration of the Analog Generator and/or 2.6.2 Configuration of the Analog Analyzers)

**12**

Graphical presentation of results, the measured values at the cursor positions being used.

**13**

Operator guidance line, also indicating the permissible range of values during data entry.

**14**

Softkeys. Entry of units and operation of the graphical display; can also be activated via mouse or function keys of external keyboard.

**15**

One of altogether 7 panels, each containing all the appertaining settings

**16 Power Switch****17**

Input and output connectors of the analyzer and generator for the digital interfaces (Option UPL-B2, see data sheet for order No.); see 2.5.3 Configuration of the Digital Generator / 2.6.3 Configuration of the Digital Analyzer.

Unbal: BNC connector

Optical: Interface EIJ CP-340, system TOSLINK

Bal: XLR connector



To avoid EMC problems the user should take care of proper shielding of the XLR connector cables.

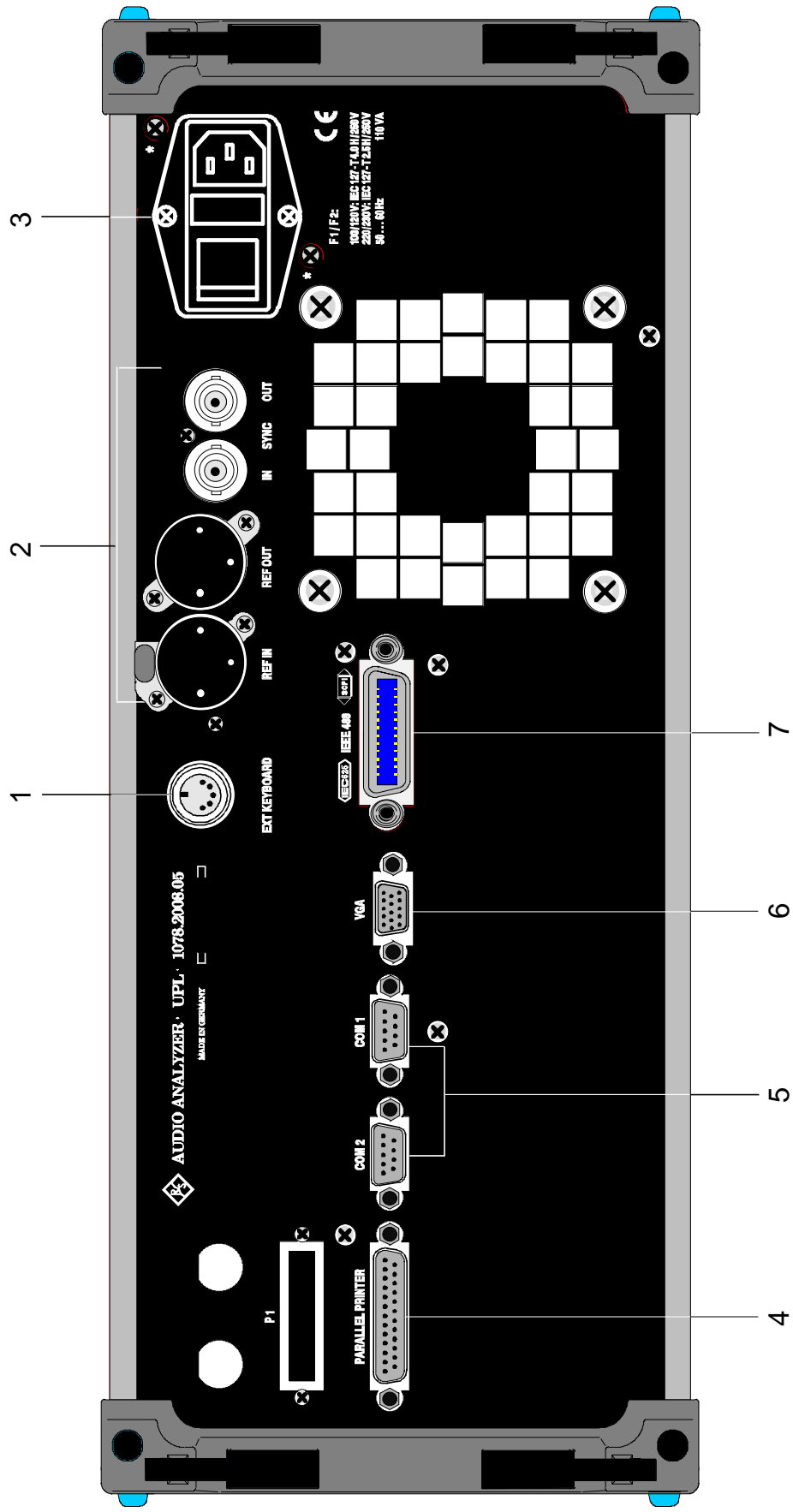

Fig. 2-2 Rear-panel view

## 2.1.2 Rear-panel View

### 1

Connector for an external keyboard (see 1.1.6, Connecting an external keyboard)

### 2

Inputs and outputs for reference and sync signals of the digital audio interfaces (Option UPL-B2) (see UPL-B2 data sheet)

REF IN: input for a digital audio reference signal (DARS)

REF OUT: output for a digital audio reference signal generated by UPL

SYNC IN: synchronization input for wordclock and video signals

SYNC OUT: synchronization output for synchronization of external devices (e.g., oscilloscope) to digital input signal

### 3

Display of the set ac voltage

### 4

IEC-BUS female connector (IEC-625/IEEE-488), Remote Control Option (UPL-B4) required, (see data sheet for order No.) (see Section 3, Remote Control)

### 5

Connector for an external VGA monitor, 15-contact D-SUB female connector, triple-row

### 6

two RS 232-C interfaces, 9-contact D-Sub female

### 7

Parallel printer interface, 25-contact D-Sub female

2.1.3 Block Diagram

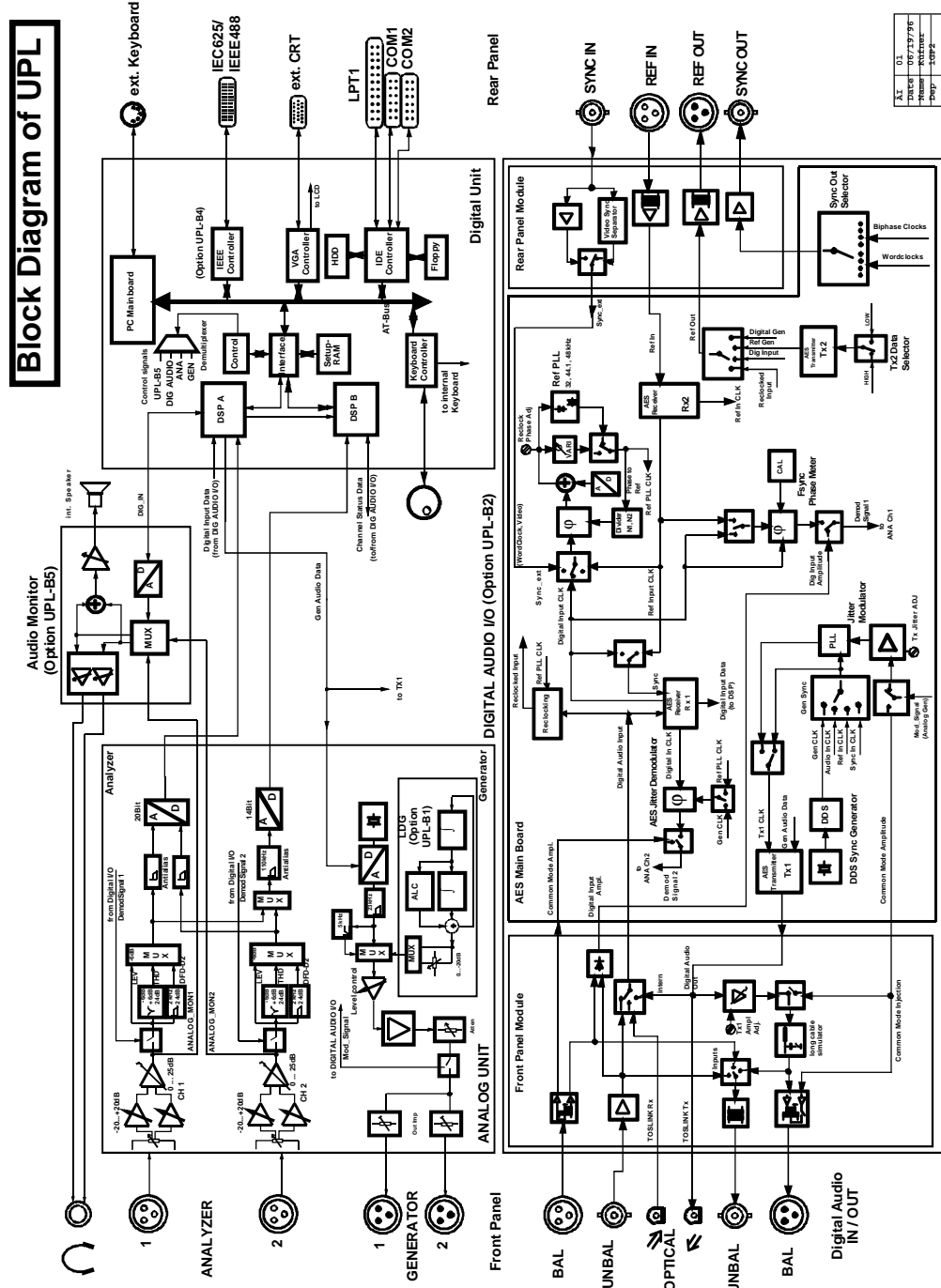

## 2.2 Operating Instructions

### 2.2.1 Brief Introduction

#### General

Subsequent to switch-on, the instrument assumes the same state as prior to switch-off. This applies to **all setting parameters** of the UPL, i.e., also for those which are currently not displayed.

The UPL is operated using the cursor (inverted field), the rotary knob and the keys SELECT, BACKSP, CANCEL and ENTER. The cursor indicates the input field for which an entry is expected. The cursor can be moved from one input field to another using the rotary knob or one of the keys  $\uparrow$ ,  $\downarrow$ , PAGE $\uparrow$ , PAGE $\downarrow$ , Tab  $\rightarrow$  and Tab  $\leftarrow$ . The cursor cannot be placed on fields with indicating function only. They are displayed in a different gray or another color.

#### Panel Structure

Associated functions and settings are displayed together in panels:

- **Analyzer panel**
  - selection of the instrument (analog or digital interfaces, frequency range)
  - configuration of the interfaces
  - measuring functions (incl. sweeps of tracking filters)
  - trigger conditions (incl. ext. sweep)
  - selection of the filters
- **Generator panel**
  - selection of the instrument (analog or digital interfaces, frequency range)
  - configuration of the interfaces
  - selection of the test signals incl. level setting
  - sweep of the generator signals
- **Filter panel**
  - definition of the filter characteristics
- **File panel**
  - storage and loading of instrument settings and measured-value sequences
  - editing of files and directories
- **Display panel**
  - definition of the type of graphical display
  - scaling of x and y-axes
  - selection of multiscans
  - entry of tolerance lines
- **Graph panel**
  - selection of cursor and marker functions
  - graphical analysis of the measurement results
- **Status panel**
  - user-configurable panel (only in combination with graphical display)
- **Options panel**

settings for

- remote control
- parameter link
- printer/plotter
- COM2-interface

- external keyboard
- external monitor
- display of the measurement result: selection of the number of digits and update rate
- display mode and language of the help texts
- version numbers of hardware and software and options fitted
- calibration
- installation of options

## Basic rules of operation

- **First select the instrument (both generator and analyzer)**

Reason: An individual set of parameters is provided for each instrument. This parameter set is saved when changing the instrument and restored when returning to the instrument. It must be loaded first before beginning to make new entries. When changing an instrument, the current choice of functions may change also (e.g., analog instruments do not offer selection of the sampling rate..).

- **Always proceed from "top to bottom" in the panels.**

Reason: Variations in parameters of individual menu items may affect the selection or the range of values of menu items further down, however not of menu items above.

- **Edit the DISPLAY panel only after the generator and the analyzer have been set.**

Reason: Everything which can be displayed graphically also depends on the selected measurement function.

Many setting parameters of the DISPLAY panel are automatically adopted from other panels, if desired, eliminating the need for setting display parameters.

## Selection of function and entry of values

### Selection of functions and parameters:

First open input box (SELECT key or space key on external keyboard), then

- |         |   |
|---------|---|
| either: | - select function or parameter using the arrow keys                       |
| or:     | - enter the first letter of the desired function on the external keyboard |

Pressing the "Enter" key acknowledges the selection, "CANCEL" retains the previous selection.

### Entry of numeric values:

- |         |  |
|---------|--|
| either: | - open the input box (SELECT key or space key on the external keyboard or first digit of the number to be entered) |
|         | - numeric entry  |
|         | - terminate with "Enter"   |

the unit remains unchanged

- |     |  |
|-----|--|
| or: | - open the input box and do the numeric entry (as above)   |
|     | - terminate by selecting the unit via softkey (or the corresponding function key on the external keyboard) |

- |     |   |
|-----|---|
| or: | - switch the rotary knob function to "value change mode" by pressing one of the keys ENTER, ← or →                                      |
|     | - vary the numeric values using the rotary knob, the position of the digit to be changed can be selected using the cursor keys (← or →) |

The permitted range for the selected function is displayed in the operator guidance line (between panels and softkeys).

## Help Functions

The UPL provides a manifoldity of help functions to support the user:

### 1. HELP function

- A HELP information is provided for each input field, optionally in German or English (HELP key or F1 of the external keyboard, selection of the language in the option panel).
- The help information corresponds always to the firmware version of the instrument

### 2. ONLINE help

The permitted range for the selected menu item is indicated in the operator guidance line (between the panels and the softkeys), respectively.

### 3. Entries exceeding the specified range

Entries which exceed the specified range permitted for the selected function are not accepted, an acoustic warning is output and the entry is modified to the respective minimum or maximum value.

### 4. SHOW I/O key

If the measured value can not be displayed, e.g., due to a missing or inappropriate input signal, the message "-Input?- Press SHOW I/O" is displayed. Pressing this key causes notes on possible error causes to be displayed together with the input and output configuration.

### 5. OUTPUT OFF

All UPL outputs can be switched off using this key, e.g., in order to protect a connected device under test.

## 2.2.2 Introductory Examples

This section provides an introduction to the operation of the UPL via the front-panel keyboard by way of examples which base on each other (operation via external keyboard or mouse, see Section 2.3 General Instructions for Use).

The examples are:

- Loading the default setup
- Frequency response measurement of the analog UPL generator from 15 Hz through 20 kHz using the sweep function
- Cutting in a filter
- Ways of presentation of measurement results
- FFT of a two-tone signal, measured at digital interface
- Hard copy of screen

**Note:** *Menu items which are not explained in the examples remain unchanged.*



### Example 1: Loading the Default Setup

(Only required to ensure that equal conditions prevail in the examples given below)

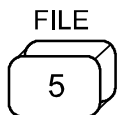

Press the figures key 5 on the front panel. As the instrument is currently not expecting a numerical input (LED above the figures keys does not light up) the secondary function indicated above the keys is automatically executed. In this example, it is the FILE function.

Causes the appertaining panel (= input window) to be displayed on the screen. The panel contains the menu items dealing with file management.

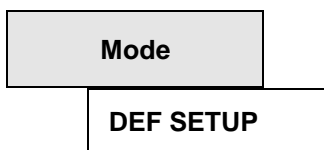

Using the keys above, place the cursor to the input field in the second line of the panel (= right-hand column of menu item "Mode" under the heading LOAD INSTRUMENT STATE), press SELECT, select DEF SETUP with the cursor, close the window using ENTER. The UPL default setup is loaded.

**Note:** The operator sequence "SELECT, selection with the cursor, ENTER" is always necessary to select a parameter, is however not explicitly stated in the following explanations.

### Example 2: Frequency Response Measurement of the UPL Generator in the Range from 15 Hz to 20 kHz using the Sweep Function

Analyzer settings:

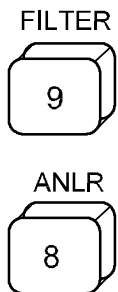

Causes the panels for setting the analyzer filters to be displayed on the screen instead of the display panel and then changes to the analyzer panel. The cursor is always located in the last-selected panel.

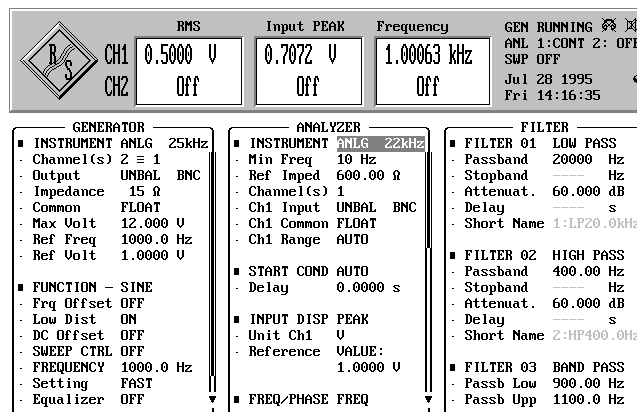
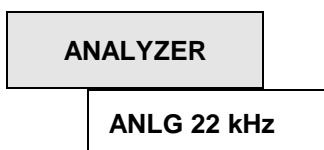

Fig. 2-3



Define which one of the three analyzers is to be used. The preset parameter is ANLG 22 kHz, which is designed for the analog interfaces and the frequency range up to 22 kHz. The panel displayed on the screen indicates all possible ways of setting this analyzer; the settings of the other analyzers, e.g. the analyzer DIGITAL are suppressed, however retained.

**Channel(s)**

1&2

Define which channel is to be measured. Select two-channel measurement.

**CH1 Input**

GEN CH2

Select the input on which the measurement is to be carried out. Switch channel 1 to GEN CH2 and channel 2 to GEN CH1. The generator outputs are now connected internally crosswise to the analyzer inputs. (This feature is required, e.g., for performing precise gain measurements or, as in this example to execute the examples without changing external connections.)

**CH2 Input**

GEN CH1

**FREQ / PHASE**

Freq &Phase

Switch to simultaneous frequency and phase measurement.

**FUNCTION**

RMS&S/N

Define the measurement function. All measurement capabilities are listed in the selection window (SELECT key). Keep the preset RMS measurement (CANCEL key).

The UPL measures continuously, which is why the measurement results of the signal currently output by the generator are already displayed on the upper range of the screen:

- the first window shows the results for both channels of the selected measurement function, which is here the rms measurement (the heading of the window reflects the selected function)
- the second window gives the peak level of the input signal, also for both channels
- the third window outputs the frequency of the input signal and the phase between both channels

#### Generator settings:

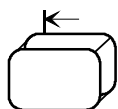

Switch to the next input field (to the left); in this case, when pressing the key no more than twice, to the GENERATOR panel and to the position the cursor was placed when the panel was left, in this example the first line.

**GENERATOR**

ANLG

Specify which one of the five generators is to be used. The preset parameter is ANLG, which is the generator for the analog interfaces.

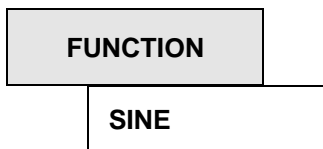

Specify the type of signal to be output. The selection window lists all possible types of signals. Keep the presetting, which is sine-wave.

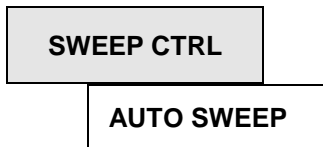

Define whether a sweep is to be carried out, whether the sweep is specified by parameters or a list and whether the sweep is to be continued automatically or manually via rotary knob. Switch to AUTO SWEEP. The panel shows some additional lines in which the sweep parameters are to be specified:



Define which parameter is to be swept, here the frequency.

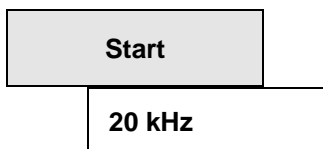

Specify the start and stop values of the sweep. With a frequency sweep selected, frequency values are expected:

Enter the start value of 20 kHz: place the cursor to the input field, press SELECT (the LED DATA above the entry block for digits lights up indicating that these keys have now the function of figures keys and cannot be used to select panels), key in 20, press softkey kHz (= F6), thus closing the input window. Select the input field for the stop value using the cursor key.

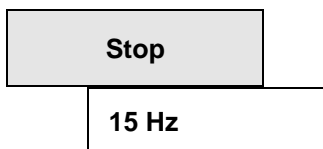

Place the digital cursor to the second position using the ←→ key, set 15 Hz using the rotary knob.

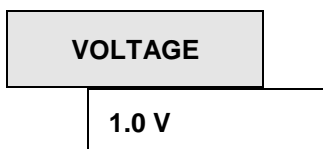

Specify the output voltage. Set to 1.0 V. The permissible range of values is output in the operator guidance line (above the softkeys).

**Note:** *The maximum level which is still permitted to be output can be defined in the menu item "Max volt" (upper section of panel) (protects custom circuits against destruction in case of a keying error). The upper range limit permissible for inputs is thus limited to this value and accordingly varied in the operator guidance line.*

**Setting the Display Parameters:**

DISPLAY



Causes the DISPLAY panel to be displayed on the screen (at the former position of the FILTER panel) and the cursor to be placed in this panel. Contains all parameters concerning the graphical presentation.

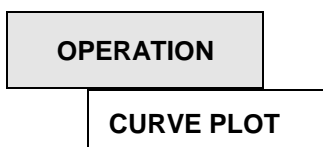

The standard setting CURVE PLOT is used to display the measurement results in the form of a curve.

Trace A
FUNC CH1

Define which data are to be collected in the measured value memory A. Here, the parameter FUNC CH1 specifies the results of the function currently active for channel 1. With rms measurement selected in the analyzer, the results of this measurement are collected.

Unit
dBr

Specify the unit with which the Y axis is to be scaled. (It is possible to select a different unit from that selected in the ANALYZER panel for numerical display of the measurement result. A different unit can be selected even at a later date in order to rescale an already available trace.)

Hint: The  $\uparrow$  key allows for jumping to the end of the selection box, thus obtaining dBr very fast.

Scale
MANUAL

The standard setting AUTO ONCE causes the scaling to be effected automatically whenever a measurement function is changed. At the beginning of the sweep, the full-scale values are set to a useful start value. After the sweep has been completed, the measured full-scale values are taken as the basis for rescaling.

Switch to Manual. Scaling can now be specified in the lines Top and Bottom.

Top
0.2 dBr

Enter the full-scale values +0.2 dBr and -0.2 dBr.

The full-scale values can be entered in units other than specified for scaling of the axis. (Renders conversion of the full-scale values when changing the scaling unit unnecessary.)

Bottom
-0.2 dBr

Trace B
PHASE

The phase measurement values are collected in the measured value memory B.

Scale
MANUAL

Switch to manual scaling. The scale for trace B is displayed in the right-hand margin of the graphics window.

Top
+ 1°

Enter full-scale values of  $\pm 1^\circ$ .

Bottom
- 1°

**X AXIS**

Indication value only. Is automatically set to the sweep control variable.

**FREQ**

**Scale**

Automatically scale the x axis with the start and stop values of the sweep.

**Auto**

**Spacing**

Select between linear and logarithmic scaling of the x axis (=sweep parameter). Keep the presetting LOG.

**LOG**

GRAPH

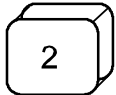

Toggle key switching from the selected input panel to the window for graphical presentation of traces, bargraphs or trace lists and vice versa. Press the key.

The graphics window will appear in **full** display (because the key was pressed when the panels were shown in full display, i.e. 3 panels simultaneously).

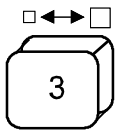

Switches from full-screen to part-screen mode and vice versa.

The panel most recently selected (here: DISPLAY panel) is shifted to the left on the screen, the GRAPH window being displayed next to it on the right side instead of the other two panels (part-screen mode).

SINGLE



Start a single sweep. The current measured values are output in the measurement result window and, at the same time, both traces are displayed. The sweep starts at the high frequencies (because of start value=20 kHz). The graph window is now active, i.e. the → and ← keys, the rotary knob and the softkeys refer to the graphical display.

The measurement of the sum frequency response of generator and analyzer is thus complete.

**Example 3: Cutting in a Filter**

DISPLAY

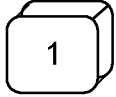

Select the DISPLAY panel.

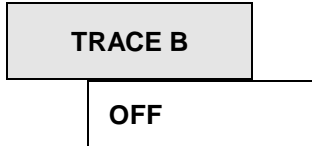

Switch off trace B.

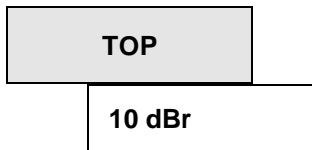

Reset the top full-scale value of trace A to 10 dBr and the bottom full-scale value of trace A to -90 dBr.

You can select Scale Auto Once instead, causing the scaling to be automatically matched at the end of the sweep.

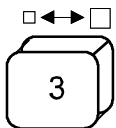
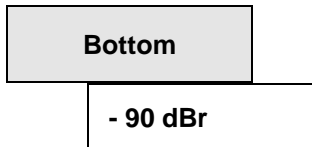

Switch from part-screen to full-screen mode (here: 3-panel display as the cursor was in a panel).

FILTER

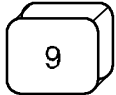

Select the FILTER panel. Up to 9 filters can be defined by the user at the same time: Enter the type of filter (lowpass, highpass...), attenuation, passband or center frequency and bandwidth you wish to use in the menu item "FILTER XX", finished. To make the entry more convenient for you, some filters are predefined.



Scroll to the first notch filter.

The parameters displayed in green or gray are values which have been determined by the internal filter design program. These values are for your information and cannot be changed.

HELP



If you need help, press the Help key to open the help window, which provides you with brief information on the current menu item, here the filters. You may select key words highlighted in the help text and obtain further information on these items by pressing SELECT.

CANCEL



Cancel closes the help window (also ENTER).

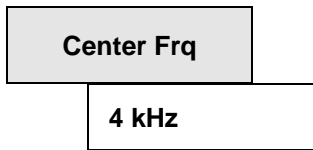

Set the center frequency to 4 kHz, the (band)Width to 500 Hz and Atten(uation) to 50 dB. The filter is now defined and is automatically designated "5:NO4000 Hz".

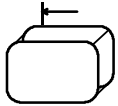

Select the ANALYZER panel using e.g. the tabulator key (press twice) and scroll to its end using e.g. the Page ↓key.

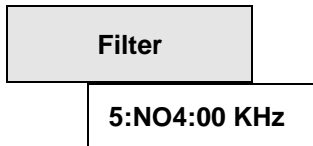

Define the filters activated in the selected rms measurement. Scroll to the first menu item "Filter" under the heading FUNCTION, open the selection window containing a list with the nine filters defined in the FILTER panel together with their short designations and all weighting filters. All settable filters can be made visible by scrolling with the ↓ and ↑ cursor keys.

Place the cursor on Filter 5:NO4000 Hz and select using Enter. The filter is now being calculated. The displayed filter parameters are UPLated in the FILTER panel.

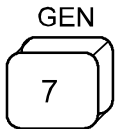

Select the GENERATOR panel.

Frequency:

Spacing

Select linear spacing between sweep variables.

LIN Points

Start

Change the start and stop values of the sweep to 3500 Hz or 4500 Hz in order to facilitate analysis of the stopband of the notch filter.

3500 Hz

Stop

4500 Hz

Stop

4500 Hz

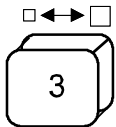

Switch from full-screen (3 panels) to part-screen mode.

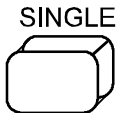

Start a new sweep. The frequency response for channel 1 with the notch filter activated is displayed. Scaling of the X-axis is automatically matched to the new sweep values.

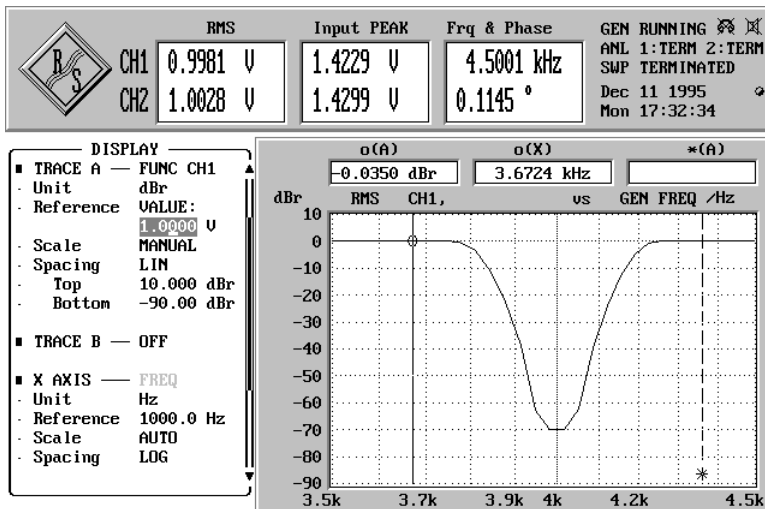
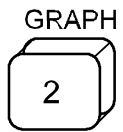

Fig. 2-4



**Example 4: Ways of Presentation of Measurement Data**



The graphical display window is activated, i.e. all entries (e.g. via rotary knob, softkeys) are relevant for graphical display.

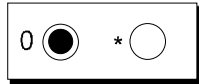

The softkey indicates by the filled circle which cursor is active, i.e. can be moved using the cursor keys or the rotary knob (in the example 0-cursor). Select the 0-cursor by pressing the softkey.

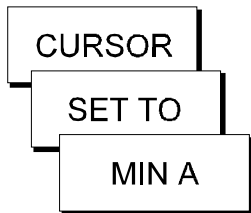

Graphical display and the cursor function can be altered using these softkeys. The key sequence CURSOR, SET TO, MIN A, for example, sets the (active) cursor to the minimum value of the sweep.

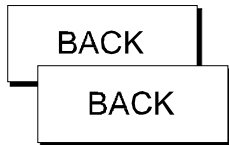

The Back softkey allows you to return to the next higher menu level. Press twice.

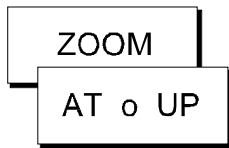

The X-axis is zoomed symmetrically around the 0-cursor by the factor of 2 with each pressing of the key.

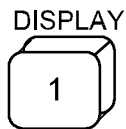

Select the DISPLAY panel.

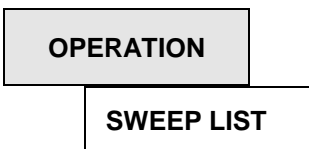

Display of measured value list for the most recent sweep. This list can be stored e.g. for further processing (FILE panel, "STORE TRACE/LIST": "STORE" Ø "TRACE A", select a file name).

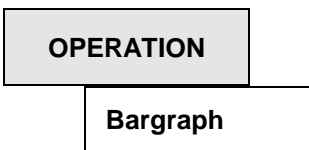

Select bargraph display. The function to be displayed and the other parameters can be selected independently for each bargraph. The minimum and maximum values indicated are reset whenever the START key is pressed.



Start a continuous sweep. The current rms values and frequency are indicated in bargraph display.

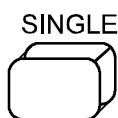

Ends the continuous sweep at the end of the last sweep.

**Example 5: FFT of a Two-tone Signal, Measured at Digital Interface**

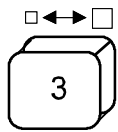

Select full-screen mode for the panels.

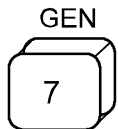

Select the GENERATOR panel.

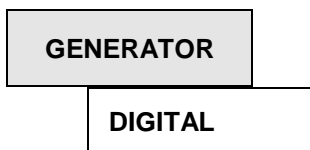

Select the generator for the digital interfaces.

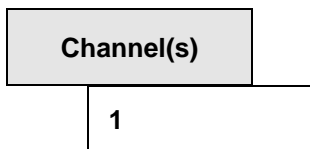

Set single-channel output.

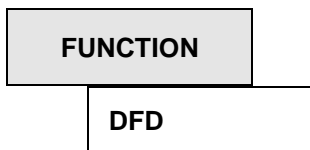

A difference tone is generated. A box is first displayed containing the question: „Really Parameter Link Yes/No“. Yes means that the corresponding DFD measurement is automatically switched on in the analyzer. Acknowledge by entering NO in this example, since an FFT is to be made. Select mean frequency (enter in menu item "Mean Freq") and difference frequency (menu item "Diff freq") is generated. The total level is 100 % FS (full scale), i.e. the peak value of the level matches the maximum number that can still be displayed ("all bits set").

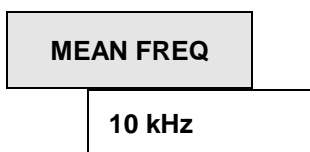

Enter mean and difference frequency.

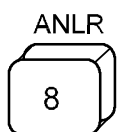
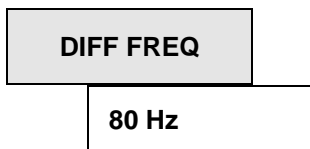

Select the ANALYZER panel.

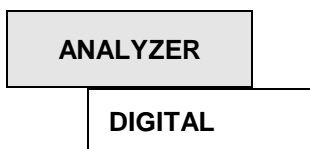

Select the analyzer for the digital interfaces.

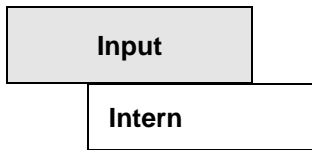

Switch to the internal digital interface to the generator. The generator is connected internally to the analyzer. (The internal sample rate is fixedly set to about 43 kHz.)

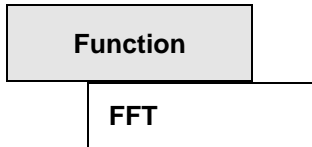

Select FFT analysis (selection in a box can always be made, alternatively, by entering the first letter on the external keyboard, i.e. „F“ in this example).

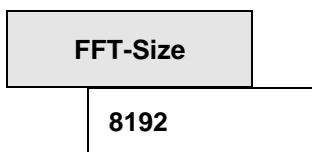

Specify the size of the calculated FFT in number of points. The higher the FFT, the higher the frequency resolution (see DISPLAY menu item "Resolution"), however the more the measuring time (see DISPLAY menu item "Meas Time").

Display

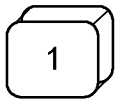

Trace A:

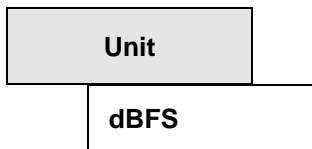

Select unit of the y-axis. Scaling is then made automatically, since the parameter "Scale" is set to "AUTO ONCE".

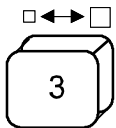

Switch to part-screen mode. The spectrum of the difference tone signal is displayed.



Select analyzer panel.

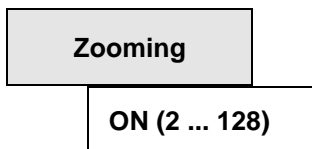

Increases the frequency resolution by one center frequency (menu item "Center") through digital preprocessing of the signal by the zoom factor (DISPLAY menu item "Zoom-Fact"). The frequency range displayed is thus decreased by the same factor (menu item "Span").

**Note:** *Not to be confused with the Zoom in Graph where the measured data are only displayed in zoomed form. Here, the measurement is really made at this higher resolution!*

Center  
10 kHz

Set to 10 kHz (= center frequency of difference tone signal)

Span  
2.49 kHz

Select 2.49 kHz. This results in an expansion by a factor of 16 (zoom factor). In the graphics window, the zoomed spectrum is displayed (see Fig. 2.5).

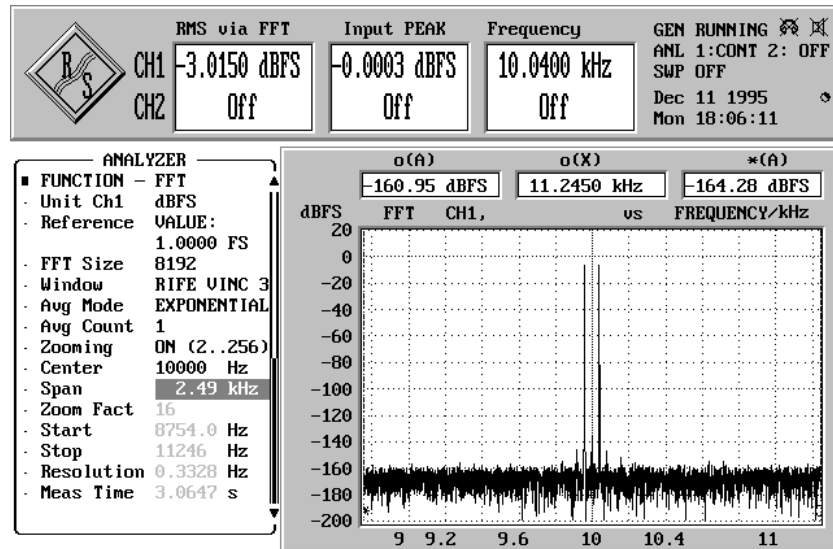

Fig. 2-5

**Example 6: Hard Copy of Screen**



Use the key in the "Span" line to enter the first column of the panel. The SELECT key is used to tick off this line and generate a copy of this line in the status panel.

STATUS



Activate the STATUS panel. In this panel, all lines which have been ticked off by the user in one of the panels are listed. It is thus possible to sum up all particularly important parameters in one panel and to print them out together with the measurement results.



The UPL can also be operated from the status panel: select a span of 1.37 kHz (the frequency resolution is increased again).

Essential parameters can thus be modified without changing the panel.

For generation of a hard copy, just connect a printer to the parallel interface and configure the UPL appropriately:

OPTIONS

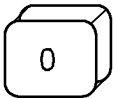

Select the OPTIONS panel.



Select hardcopy output to a printer.



Select the appropriate printer driver from the list provided. Subsequently, change to the type of display which is to be printed (e.g., activate status panel again).

HCOPY



A box is displayed which allows for selection whether and which comment is added to the printout. Upon acknowledging the request, the printjob is started.

It is advisable with fast printers, to stop the measurements by pressing the STOP key thus increasing the printwork.

## 2.3 General Instructions for Use

The UPL is very easy to operate, especially when you observe the following recommendations:

- **First select the instrument (both generator and analyzer)**

Reason: An individual set of parameters is provided for each instrument. This parameter set is saved when changing the instrument and restored when returning to the instrument. It must be loaded first before beginning to make new entries. When changing an instrument, the current choice of functions may change also (e.g., analog instruments do not offer selection of the sampling rate..).

- **Always proceed from "top to bottom" in the panels.**

Reason: Variations in parameters of individual menu items may affect the selection or the range of values of menu items further down, however not of menu items above.

- **Edit the DISPLAY panel only after the generator and the analyzer have been set.**

Reason: Everything which can be displayed graphically also depends on the selected measurement function.

Many setting parameters of the DISPLAY panel are automatically adopted from other panels, if desired, eliminating the need for setting display parameters.

### General Hints as to Mouse Operation

If a mouse is connected to the UPL (see Section 1.1.7 Connecting a Mouse), an arrow the position of which can be changed by moving the mouse appears on the screen. The arrow can be moved across the entire screen. If the cursor is on the desired position, the action (see the following Section) is always triggered by pressing a mouse key (= clicking on a field).

Further, the mouse can be used to

- select between the three different display modes:  
3-panel display, part display and full display, with the left and right mouse key being pressed simultaneously in the shaded area (cf. Fig. 2-6, a and c). The mouse click to change the display modes must be at a position in the panel which is not assigned by an operable field.
- change between panel and graphics in the part display, with the left mouse key being pressed in the shaded area (cf. Fig. 2-6 b).
- change the panel by clicking the panel heading using the left mouse key (cf. Fig. 2-6 d).
- entry of file names, comments etc. is easier than via the front-panel keypad. If no external keyboard is connected, a "screen keyboard" is displayed. Its keys can be actuated by selecting them using the mouse.

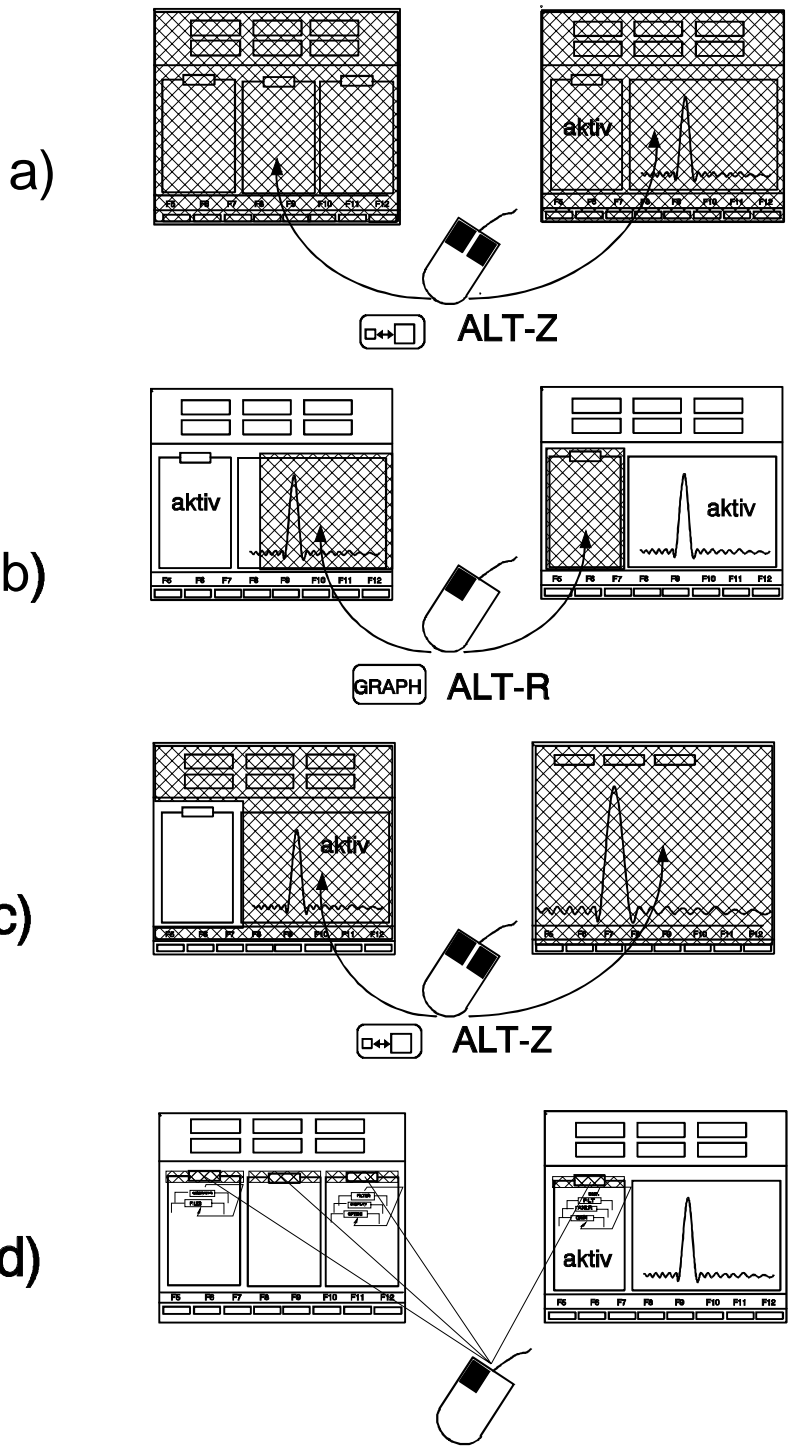
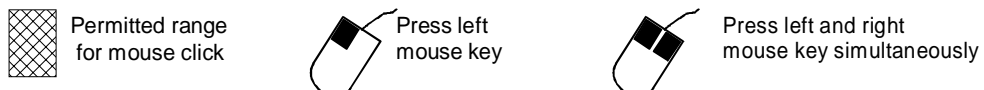

Fig. 2-6

### 2.3.1 Panels

Related settings and functions are always combined to form a so-called panel in the UPL. Each panel has a name (= heading in the upper margin of the panel), which is used to call the panel.

In addition to the panels, there is another window in which the measurement results are displayed graphically. Selection and activation of this graphics window matches that of a panel, which is just larger than the panel.

Only one panel can be active at one time. An active panel is characterized by the cursor (field in inverse display) being placed in it, i.e. entries can be made only in this panel. On the whole, there are eight panels (incl. graphics window), a maximum of 3 panels being displayable on the screen at one time.

A panel is selected and, if required, displayed on the screen using

- the panel keys on the front panel
- the short-key combinations of the external keyboard (option)

Switchover between visible panels is also possible by:

- the Tab →, Tab ← keys.
- moving the mouse cursor (arrow) to the desired panel and clicking on a field
- the short-key combination of the external keyboard (option) (see table 2-1).

When a panel is called, the position of the cursor matches that at the time when the panel was left (exception: changing the panel using the mouse; in this case the position of the mouse cursor is relevant). Thus, you can quickly switch between constantly recurring input points.

The keys on the front-panel keypad named DATA/PANEL are assigned two functions. The first is the fast selection of the panels (see Table 2-1), the second function is that of a input block for numbers. Switchover from first to second function and vice versa is made automatically. If the UPL expects the entry of figures (after having pressed the SELECT key with the cursor placed on a field for the entry of numerical values, see Section 2.3.2 Data Entry), the keys serve as figures keys, otherwise as keys for panel selection. If the entry of data is expected, the LED above the designation DATA lights up.

Table 2-1 Panels and their functions

Panel name	Front panel key	Key combination ext. keyboard	Function
Analyzer	ANLR	Alt-A	Settings of all six analyzers
Generator	GEN	Alt-G	Settings of all five generators
Filter	FILTER	Alt-T	Filter definitions of the analyzers
File	FILE	Alt-F	Loading and storing of traces and lists, editing of files and directories
Display	DISPLAY	Alt-D	Parameters for graphical presentation of measurement results
Status	STATUS	Alt-S	Summary of user-definable menu items of any panel
Options	OPTIONS	Alt-O	Settings for printer/plotter, ext. keyboard, ext. monitor, information on options fitted, calling of calibration routines
Graphics	GRAPH	Alt-R	Activates panel or graphical display (toggle function)
Full-screen/part-screen	☐ ←→ ☐	Alt-Z	Switching from full-screen to part-screen mode (toggle function)



**Note:** For a complete list of short-key combinations for operation via an external keyboard, refer to Section 2.1.1, Front-panel View or to the HELP menu under UPL (HELP key or F1 of the external keyboard).

Every panel has a fixed position on the screen (except when part-screen mode is simultaneously selected, see the following Section):

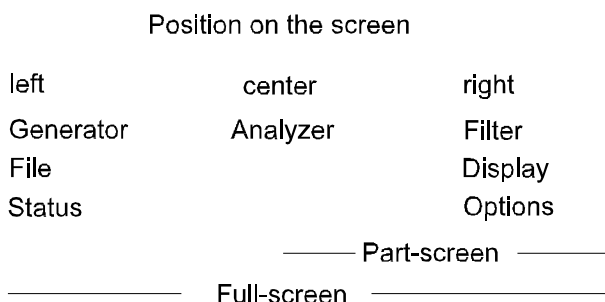

The GRAPH key allows you to switch from the active panel to graphical display and vice versa.

The  $\square \leftarrow \rightarrow \square$  key is used to change from full-screen mode (graphics over the entire screen or 3-panel display, depending on whether graphics or a panel is active) to part-screen mode (a panel by the side of graphics) and vice versa.

In part-screen mode, the panel used most recently moves to the left side of the screen. Any subsequently called panel is placed on this position, too, allowing the user to display and print any panel (especially the  $\rightarrow$  STATUS panel) together with the graphical presentation of results at one time.

After the part-screen mode has been switched off, the current panel is reshifted to its normal position.

## Scrolling in the Panel

If a panel has more lines than can be displayed on the screen section, the  $\uparrow$ ,  $\downarrow$ , Page $\uparrow$  and Page $\downarrow$  keys (or the corresponding keys on the external keyboard) can be used for scrolling in the panel. The bar in the right-hand margin of each panel stands for its complete size, the dark section representing the section currently visible on the screen. Arrows show you in which direction to scroll to cause the lines not visible to be displayed in the window.

With the mouse connected, the panel contents is scrolled by one line whenever the respective arrow is selected. Pressing and holding down the mouse key causes the contents to be scrolled until the key is released. Any desired panel section can be made visible by selecting the dark part of the bar and positioning it appropriately by moving the mouse with the key held down.

## STATUS Panel

This special panel can be called only in part-screen mode. Any line in any panel can be marked with a tick in the first column (select the position using the Tab  $\leftarrow$ ,  $\uparrow$  and  $\downarrow$  keys, press SELECT, the tick is switched on or off (toggle function)). Each marked line is taken over into the so-called STATUS panel, thus allowing the user to sum up all important parameters in one panel. It can be simultaneously displayed with the measurement results and their graphical representation, which is of particular interest for the documentation of results (see 2.8 STATUS Panel).

The UPL can be operated from the STATUS panel as well as from all other panels, thus allowing you to execute any repetitively used control sequence from one panel only.

## Changing an Instrument

The UPL has three analyzers (one in each of the measurement ranges 22 kHz and 110 kHz for the measurement on analog interfaces, three for the measurement on digital audio interfaces). All analyzers are set in the ANALYZER panel. The generators are set correspondingly in the GENERATOR panel.

Each of these instruments has its own data set, each with a different structure. The data sets are different with respect to

- the selection of the displayed menu items (= lines of the panel). All settings possible for the selected instrument (e.g., of the analyzer for analog interfaces and the frequency range up to 22 kHz), the settings of the other instruments (e.g., of the analyzer for the digital interfaces) are suppressed, however retained in the background. This ensures fast and convenient operation of the UPL despite the wide variety of possible settings.
- the permissible range of values for the parameters. It is not possible, for example, to set a sample rate in the analyzer "ANLG 22 kHz", however it is feasible in the analyzer "DIGITAL".
- the selection of the functions. To give an example, the analyzer for the frequency range up to 22 kHz is provided with more measurement capabilities than the analyzer for the frequency range up to 110 kHz.

### Parameter Link

It may sometimes be required with changing the instrument that the set of parameters which had been set last time is not set, but that the one of the currently used instrument is set instead. This is, e.g., the case when checking converters, if the same measurements are to be performed at the digital interfaces as have been performed at the analog interfaces. The option panel allows for selection, if any parameters of the current instrument are to be set and which ones, i.e., which are not to be overwritten by the loaded data set (see 2.15.8 Parameter Link). If this so-called parameter link is activated, a query box is displayed with changing the instrument where the user can select once again, whether the parameter link is to be carried out or not.

For switching between the instruments, follow the instructions below:

- Place the cursor on the input field of the first panel line (= right-hand column of the line named ANALYZER or GENERATOR) using the mouse or the ↑, Page↑ and Tab → keys. Then press

SELECT

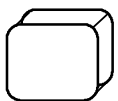

press

(or any mouse key or space on the external keyboard). A selection window with a list of all available analyzers or generators will be displayed.

- Select an instrument using the ↑ and ↓ keys, rotary knob or mouse and press

ENTER

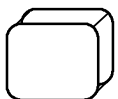

press

(or any mouse key or Enter on the external keyboard). The selection window is closed and the settings of the "former" instrument are saved. The panel with the menu items and all settings appertaining to the instrument most recently selected is built up anew.

### Changing Functions or Parameters

Changing a function (e.g. from RMS to THD measurement or, from sinewave to multi-sinewave generation) is performed analogously to changing an instrument, which is explained above: all menu items including the parameters appertaining to the function are retained. (The frequencies and amplitudes of all multi-sinewaves are still present, even when the frequency and amplitude of the single sinewave have been changed in the meantime).

Also when changing parameters, the menu items not required are suppressed, their parameters are however retained and are available again when they are activated.

#### Example:

Changing from "OFF" to, for example, "AUTO SWEEP" in the menu item "Sweep CTRL" causes the menu items (=lines) required in this mode "Start", "Stop", "Points" etc. to be displayed together with the parameters set for the most recent sweep. These lines are canceled again, when the sweep is switched off.

**Note:** *The order of the menu items in the panel is selected such that varying a parameter may induce changes in the lines further down, however never in lines further up in the panel. We advise you to proceed in the given order from top to bottom.*

### Parameter Link

It may sometimes be required with changing a function that the set of parameters which had been set last time is not set, but that the one of the currently used function is set instead. This parameter link can be selected in the option panel (see 2.15.8 Parameter Link). If this so-called parameter link is activated, a query box is displayed with changing the function where the user can select once again, whether the parameter link is to be carried out or not.

## 2.3.2 Data Entry

The cursor (field in inverse display) indicates for which input field an entry is currently expected. The cursor can be moved from one input field to the other using the front-panel keys ↑, ↓, Page↑, Page↓, Tab → and Tab ← or the corresponding keys on the external keyboard. Some fields in the column with the input fields have display function only, the cursor cannot be placed into them. They are displayed in a different color or in a different gray shade. Menu items without input field serve as headings.

**Note:** *The same menu item may have an input field or just serve as heading depending on the parameters selected in other menu items.  
Note Section 2.3.2.6 Data Input or Output during Measurements*

### 2.3.2.1 Selecting a Parameter

Place the cursor on the desired input field. Press the SELECT key (or the space bar on the external keyboard) or any mouse key to open a selection window containing all parameters appertaining to this menu item. The cursor↑ and cursor↓ keys or the mouse are used to select the parameters. The window is closed again using ENTER (also with external keyboard), CANCEL (or ESC on external keyboard) or by pressing a mouse key. The parameter of the selection window is taken over with ENTER whereas the former setting is retained with CANCEL. Also, the parameter is accepted when selected with the mouse or, the window is closed while the former setting is retained when any point outside the selection window is selected using the mouse.

**Note:** *The contents of the selection windows are not constant but vary depending on the other settings selected.  
For a list of all key combinations assigned to the front-panel keys of the external keyboard, refer to Section 2.1, Front- and Rear-panel Views. The key combinations are therefore not explicitly specified in the following description.*

### 2.3.2.2 Entry of Numeric Data

#### Entry using the rotary knob

- Place the cursor on the desired input field using the rotary knob or the cursor keys ↓ or ↑
- press ENTER or move the numerical cursor (= underscore) to the position to be incremented or decremented.
- the color of the current field changes and the rotary knob can be used to scroll the figure.

The digits can be varied only within the range of values specified in the user info line. A warning is audible when the limit values are reached (can be deactivated, see 2.15.2 Beeper On/Off)

After having left the field by one of the keys ↓, ↑, PgUp, PgDn, TAB, SHIFT TAB or CANCEL the rotary knob is used to move the cursor up and down the panel.

Sweep parameters (e.g. generator frequency or level) may be incremented or decremented by a user-defined value which is set by specifying the step width of the manual sweep.

**Note:** *Some settings require other settings in the panel to be varied (example: when changing the reference voltage, all settings referring to this value must be converted). In this case, the complete panel must be rewritten whenever a value is changed, thus slowing down the rotary knob function.*

#### Entry using the numeric keypad

Position the cursor to the desired input field, press SELECT or any mouse key or a number key on the external keyboard causing a small input window with the current value to be displayed. (The number of digits available in the input window may be higher than that of the input field allowing the user to enter values with a higher accuracy than can be displayed in the panel, if required. After having closed the window the rounded value appears in the panel.)

If the value is to be re-entered completely, simply enter the figure using the numeric keypad. The first pressing of the key automatically deletes the old value. The BACKSP key is used to delete the figure to the left of the cursor during input.

If you wish to change only individual figures, place the numerical cursor on the respective position using the → or ← and enter the desired figure (changing the position of the numerical cursor before the entry of the first figure or deleting a character causes the former value to be retained).

Close the window using

- ENTER: the value entered anew is accepted
- CANCEL: the old value is retained
- Softkeys: the selected unit is set and the value entered anew is accepted
- Clicking with the mouse inside the input window: the value entered anew is accepted
- Clicking with the mouse outside the input window: the value entered anew is not accepted

Entries outside the specified range of values are not accepted, a warning is audible (can be switched off, see 2.15.2 Beeper On/Off) and the entry is changed to the appropriate minimum or maximum value.

#### Changing the unit at a later date

Place the cursor on the unit field (using Tab → in the numeric input field) causing a softkey line with the units permissible for this menu item to be displayed. The current numeric value is converted for the selected unit by pressing the respective softkey (see also next Section).

### 2.3.2.3 Using the Softkeys

The softkeys (eight keys at the bottom screen margin) are used for the entry of units and operation of graphical display. The MORE softkey switches to further softkeys available to this operating point, the BACK softkey returns to the next higher softkey level.

The softkeys can be activated

- using the front-panel keys
- using the function keys on the external keyboard specified in the softkey labeling
- by mouse click.

### 2.3.2.4 Help Line

The help line is between the panels and the softkeys and always refers to the input field marked by the cursor. It provides you with information on which keys to use for further operation or the permissible range of values. Entries outside the specified range are not accepted, a warning is audible and the entry is replaced by the appropriate minimum or maximum value.

**Note:** *The maximum permissible range of values may depend on other settings, i.e. is not constant. For further information on the current menu item, press the HELP key.*

### 2.3.2.5 Entry of File Names

Position the cursor on the input field of the menu item the file name of which is to be changed and press the SELECT key. A dialog window consisting of three more windows will be displayed.

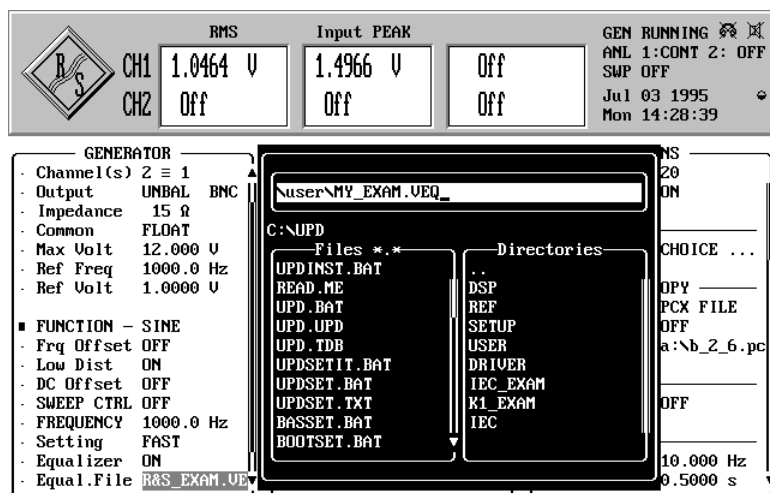

Fig. 2-7

- The top window serves for editing the file name (incl. path name, if required). When selecting the dialog window, it is preassigned with the current file name of the selected menu item. The line below indicates the currently used path (disk drive and directory, see also paragraph "Working Directory").
- The "Files" window allows you to select an already available file. This window lists all files contained in the current path of the file type provided as standard for this menu item. (The type of file is identifiable by the three letters after the point. Different types of files are used for the different tasks of a file (e.g. limit file, sweep list file etc.) to facilitate file management. For a list of all types and their meanings, 2.9.1 Loading and Storing).

- The "Directories" window allows the user to change the directory. It contains the subdirectories (if any) of the current path. The directory name "..." represents the higher-order directory with respect to the current directory.

The Tab ← and Tab → keys can be used to switch between the above windows.

### Selecting an already available file

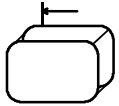

Change to the Directories window using the tab key in the open dialog window.

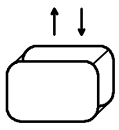

Select the desired directory. Scrolling is possible as in a panel, also with the help of Page ↵ (see Section 2.3.1 Panels)

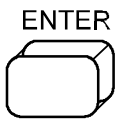

The newly selected, current path is displayed, the window contents are UPLated, \*.xxx is entered as file name, where xxx stands for the type of file provided as standard for the selected menu item.

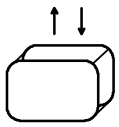

Change to the Files window and select the desired file.



The selected file name is taken over into the input window where it can still be modified (see below "Entering a new file name"). Entering an already available file name is to be preferred, in particular when no keyboard is used as entering a completely new name is then time-consuming.



Close the dialog window, storing or loading is effected with the name stated in the input window. CANCEL closes the window without any operation carried out, the old file name being retained.

### Entering a new file name

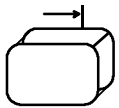

- Change to the uppermost window.



The file name to be entered must comply with the MS-DOS conventions: a maximum of eight characters followed by a point and the data type consisting of a maximum of three characters. The <> = , ; : . \* ? [ ] ( ) ^ + ! characters must not be used.

There are three ways of entering the file name:

- using an external keyboard
- with the help of the mouse (also with no external keyboard connected)
- via the front-panel keypad

For entries without using an external keyboard, place the input cursor (" ^" character) on the position there characters are to be entered using the → or ← key. Press the mouse key or the SELECT key. A selection window with all characters which can be entered will be displayed. Select a character (using the mouse or →, ← keys), which is then inserted into the file name at the cursor position whenever a mouse key or the SELECT key is pressed. An entry at the first position causes the former file name to be automatically deleted. BACKSP is used to delete the character to the left of the input cursor. Close the selection window using the ENTER key, by selecting <ok> in the selection window or by selecting one of the three windows in the dialog window with the help of the mouse.

When using an external keyboard, editing is made directly in the input window, the above selection window with the alphabet is not displayed. On **power-up**, the UPL checks whether an external keyboard is connected. (Being not initialized when connected after power-up of the UPL, the key-board does not function properly.)

The following can be entered in the input window (see also previous section "Working Directory"):

- File name without path specification: The path specified in the next line is used. Storing and loading is initiated using ENTER.
- File names with wild cards (don't care characters \* and ?). ENTER serves to display the respective files in the FILES window, e.g. \*.LUP is used to list all files of this type. The search for file types other than the standard files is thus possible.
- Only a path. The path and window contents are correspondingly updated.
- File name incl. the complete path specification. Storing and loading is initiated using ENTER.

### Using the Working Directory

Files can be summed up in a working directory for certain projects or instrument users (see Section 2.9.1 Loading and Storing). The path specified in the menu item WORKING DIRECTORY of the FILE panel (e.g. C:\PROJECT1) precedes all file names used in the UPL at the time of loading or storing, provided they do not begin with "\" or "Drive:\".

#### Example:

Entering the file name MEAS5\MYFILE.XYZ results in the path C:\PROJECT1\MEAS5\MYFILE.XYZ, to use the above example again.

### 2.3.2.6 Data Input or Output during Measurements

#### Internal or external sweep switched off

(**External sweep:** The parameter AUTO is not selected for menu item START COND of analyzer)

All entries are permissible at any time. After having terminated an entry (ENTER), the present measurement or output is aborted, the newly selected parameters are set and the measurement or output is restarted.

Note that with graphical display (e.g. continuous FFT, bargraph, histogram of intermodulation measurement), the graphics output is interrupted when a selection window is opened, however the measurement continues. After having closed the window, the graphics is restored, or, when display parameters were changed, the graphics is deleted and built up again with the new settings (in the case of continuous FFT, this is performed only at the end of the present FFT).

#### Internal or external sweep switched on

(**External sweep:** The parameter AUTO is not selected for menu item START COND of analyzer)

Any entry causes the sweep to be stopped (i.e. it is stopped after conclusion of the current sweep) and then the action initiated by the activated key to be executed because modifications to parameters during a sweep may affect the measurement, thus rendering the measurement results displayed on the screen questionable.

#### Exceptions:

The following keys can be activated or the following actions can be made without aborting a sweep:

- Entries in the DISPLAY panel
- Display of any panel without varying parameters
- Rotary knob (enables a manual sweep, (see 2.5.4.2 Sweeps)
- Softkeys of graphical display of results

Changes in the GENERATOR, ANALYZER, FILTER or STATUS panels cause the internal instrument status to be set to "measurement invalid" because the measurement results do not match the setting parameters. The attempt to save or print these measurement results is prompted by an appropriate warning (see Section 2.9.1 Loading and Storing and Section 2.14 Printing/Plotting/Storing the Screen Contents (OPTIONS Panel)). It is no longer possible to continue the sweep using the CONT key, a restart with the START or SINGLE key is required.

Modifications to parameters in the DISPLAY, FILE and OPTIONS panels do not affect the measurement results; the internal instrument status is "measurement valid". Entries are immediately processed. (Exception: With continuous FFT, modifications to the display parameters are considered only in the next spectrum to be output). The measurement can be continued with the CONT key.

**Note:** See also 2.11 Starting and Stopping of Measurements or Sweeps



### 2.3.3 Display of Measured Values

The display windows for a maximum of 6 measurement results are in the upper section of the screen except for in full-screen mode.

To the right of the windows, there are status information on the current instrument state, see 2.3.5 Status Display.

	Measured value display			Status block
	RMS Select	Input Peak	Frequency	
CH1	-41.18 dBV	12.34 mV	1.234 kHz	GEN-Status see 2.3.5 ANL-Status " SWP-Status " Apr01 1992 Wed20:44:50
CH2	22.11 DB $\mu$ V	9.876 V	1.234 kHz	

Fig. 2-8

- 1st column: Measurement results of the selected measurement functions ...
  - 2nd column: Measurement results of the measuring function selected in menu item „Input Disp“ (in the example, peak value display of input levels) ...
  - 3rd column: Frequency and phase measurement results ...
- ... each for both channels at one time.

**Display of measured values:**

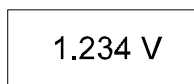

The measurement results are shown in 3 ½-, 4 ½- or 5 ½-digit display i.e. the decimal point jumps at the transition 2.999 ↔ 3.00, 29.99 ↔ 30.0, 299.9 ↔ 300 etc. If a measured value happens to be in the transition range, hysteresis prevents an unsteady display. The number of digits and the rate of updating the displayed measurement results can be selected in the option panel - depending on the measurement function (see 2.6.5 Functions). Independent of this reading rate, the measurement rate can be selected for the individual functions (see 2.6.5 Functions). Only the function influences the measurement accuracy. With fluctuating measurement results it is advisable to reduce the number of digits to be displayed (reading resolution) in order to obtain a steady display. The measurement results can be displayed with various units individually for each channel. The unit is selected in the analyzer panel with the measurement function.



The measurement channel or function is OFF, for example, Input Peak = OFF

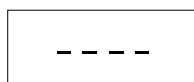

There is no measurement result related to the selected function available, e.g., there are no frequency measurement results during DC measurements.

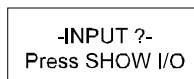

The measurement result cannot be displayed because of an inappropriate input signal. A hint about how to eliminate the error appears when pressing the SHOW I/O key (see 2.6.3).

## 2.3.4 Settling Process

### 2.3.4.1 Introduction

#### Why settling is necessary:

If a modification is made at the generator of the UPL and if the settling time of a test item is known, it can be considered using the delay indication in the analyzer panel (cf. 2.6.4 Ways of Starting the Analyzer, Ext. Sweep). Settling processes within the UPL are automatically considered so that the user does not need to take these times into account. The analyzer supplies settled, valid measurement results.

If there is a test item with an unknown transient response between the generator and the analyzer of the UPL or if a test item is fed by an external generator, a transient response will usually be observed at the measurement result after a change of the signal or a manipulation at the test item (in the case of a high measurement rate compared to the settling time) until the display has stabilized. The steadied readout is then accepted to be valid.

The settling process in the UPL has the aim of imitating and automating this procedure. A measured value is only output if it satisfies a certain accuracy the user can enter freely (maximal deviation from the settled final value, later the expression "tolerance" is used). The settling process is preferably used in cases where measurements are to be made at test items with an unknown or changing settling time. The settling process can be combined with a delay so that an undesired signal characteristic can be ignored before the settling process begins as of the starting time of the measurement (change of generator or of signal with external sweep). The settling process can also be used to steady the readout by rejecting values which do not comply with the accuracy entered.

#### How the settling process is realized:

The value measured by the UPL is permanently compared with up to 5 measured values stored immediately before. A measured value is only accepted as valid if it is within the tolerance limits entered by the user with regard to the previous measured values. Otherwise it is rejected and included in the series of comparison values for the next measured value.

#### Where settling can be set:

The settling process can be applied to:

- External sweep (START COND → FREQ CH1 | FREQ CH2 | VOLT CH1 | VOLT CH2)
- Frequency results (FREQ/PHASE → FREQ)
- Phase results (FREQ/PHASE → FREQ&PHASE)
- Function results for all functions except for FFT, POLARITY and WAVEFORM (START COND → AUTO)

The settling process for the external sweep and the settling process for the frequency, phase or function measurement can be combined.

#### Exception:

Settling process in combination with external sweep with a change of the frequency as trigger condition (setting START COND → FREQ CH1 | FREQ CH2) cannot be combined with a settling of the frequency results. Reason: There are already settled frequency results which do not have to be weighted using a settling process again!

All settling settings can be activated in the ANALYZER panel in the corresponding panel sections under menu item "Settling".

### 2.3.4.2 The Settling Parameters:

The appropriate settling parameters are stored for every measurement function so that the settling settings once selected and well tested are effective in a change of the function.

#### Settling:

##### Settling → EXPONENTIAL

sets a result comparison window with an exponential characteristic whose lock-in range is determined by the setting "tolerance". This setting is ideal for measurements on test items with a normal exponential transient response and usually covers most applications (cf. Fig. 2-9).

##### Settling → FLAT

sets a result comparison window with a fully flat characteristic (tolerance band) whose lock-in range is determined by the setting "tolerance". With a very small tolerance entered, this setting only supplies a measurement result if the test item has quasi completely settled. Due to this stricter settling condition, the time until a valid measured value is recognized is usually longer than with the EXPONENTIAL setting (cf. Fig. 2-9).

##### Settling → AVERAGE

causes an arithmetic averaging for the number of measured values set in samples. After a restart of the measurement by pressing the SINGLE key at the UPL or a parameter entry which must result in a restart of the measurement such as modifications of the generator signal or of the settling parameters themselves, the average is only output when the number of measurements set by means of "samples" has been made. If the memory is full of measurement results, the most previous result is dismissed and the average output with every new result. In this phase, an abrupt change of the signal results in a creeping change of the average (low-pass properties).

#### Samples:

This value indicates the number of measured values used for tolerance and resolution comparison. Samples = 6 means that the latest measured value is compared with the 5 last measured values.

#### Tolerance:

The tolerance value denotes the maximally permissible deviation from the previous measured value a settled measured value may have in order to be classed as valid by the UPL. The value of the maximally permissible deviation of the current measured value compared to the 2nd/3rd/4th and 5th last measured value is determined by the EXPONENTIAL | FLAT setting.

### Tolerance characteristic

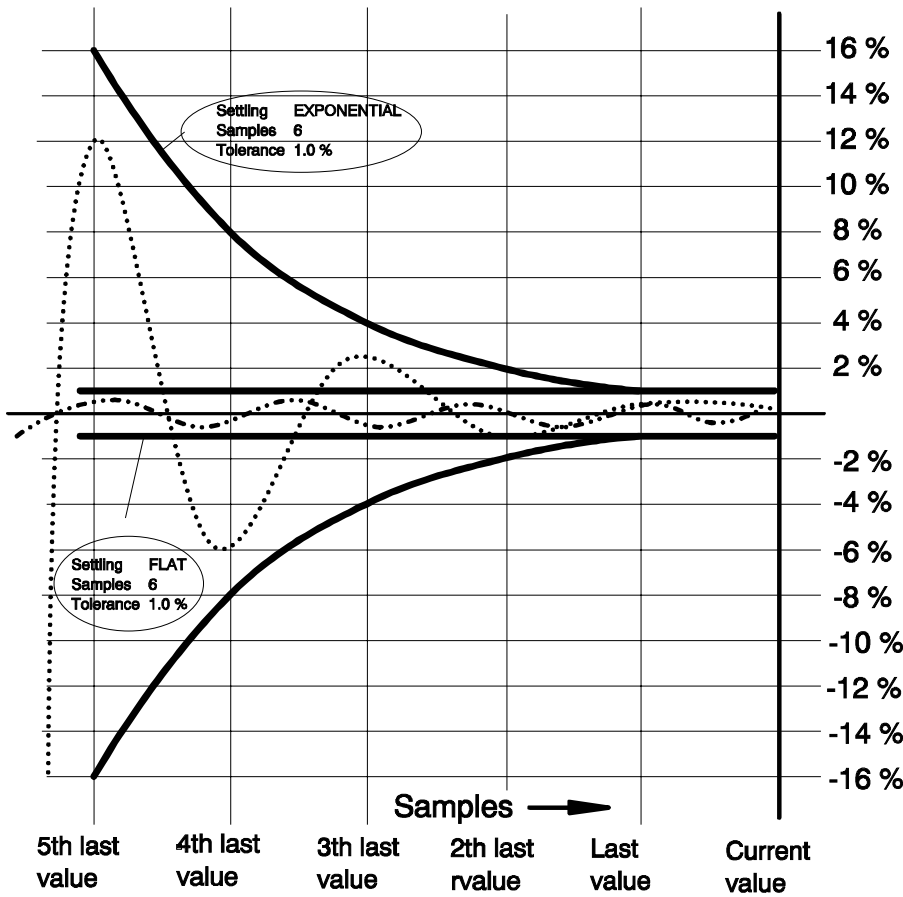

Fig. 2-9 Tolerance characteristic

When the measured values are checked as to whether they satisfy the tolerance condition,

- volt is always used as a basis for the measurement result for level measurements RMS & S/N, RMS SELECT, PEAK & S/N, Q PK & S/N and DC,
  - % is used as a basis for the measurement result for intermodulation measurements THD, THD+N/SINAD MOD DIST, DFD and WOW & FL, and
  - Hz is used as a basis for the measurement result for frequency measurements, irrespective of the unit in which the measurement result is displayed.
- For a phase measurement, it is only possible to set the resolution (see resolution).

**Examples:**

In the following examples, Settling → EXPONENTIAL and samples = 6. If the tolerance is 1%, this means that the current measured value must be identical to

- the last measured value ±1% (or ±0.086 dB)
- the 2nd to the last measured value ±2% (or ±0.172 dB)
- the 3rd to the last measured value ±4% (or ±0.340 dB)
- the 4th to the last measured value ±8% (or ±0.668 dB)
- the 5th to the last measured value ±16% (or ±1.289 dB).

Level measurement, tolerance 1 %:

A measured value of 1 V is displayed as settled, when

- the last measured value is between 0.99 and 1.01 V ( $\pm 1\%$ )
- the 2nd to the last measured value is between 0.98 and 1.02 V ( $\pm 2\%$ )
- the 3rd to the last measured value is between 0.96 and 1.04 V ( $\pm 4\%$ )
- the 4th to the last measured value is between 0.92 and 1.08 V ( $\pm 8\%$ )
- the 5th to the last measured value is between 0.84 and 1.16 V ( $\pm 16\%$ )

Intermodulation measurement, tolerance 1%:

A measured value of 0.01 % is displayed as settled, when

- the last measured value is between 0.0099 and 0.0101 % ( $\pm 1\%$ )
- the 2nd to the last measured value is between 0.0098 and 0.0102 % ( $\pm 2\%$ )
- the 3rd to the last measured value is between 0.0096 and 0.0104 % ( $\pm 4\%$ )
- the 4th to the last measured value is between 0.0092 and 0.0108 % ( $\pm 8\%$ )
- the 5th to the last measured value is between 0.0084 and 0.0116 % ( $\pm 16\%$ )

Intermodulation measurement, tolerance 0.1 dB (1.16 %):

A measured value of -80 dB (0.01%) is displayed as settled, when

- the last measured value is between -80.1 and -79.9 dB ( $\pm 1.16\%$ )
- the 2nd to the last measured value is between -80.2 and -79.8 dB ( $\pm 2.32\%$ )
- the 3rd to the last measured value is between -80.4 and -79.6 dB ( $\pm 4.63\%$ )
- the 4th to the last measured value is between -80.8 and -79.2 dB ( $\pm 9.26\%$ )
- the 5th to the last measured value is between -81.7 and -78.5 dB ( $\pm 18.53\%$ )

Frequency measurement, tolerance 1 %:

A measured value of 1000 Hz is displayed as settled, when

- the last measured value is between 990 and 1010 Hz ( $\pm 1\%$ )
- the 2nd to the last measured value is between 980 and 1020 Hz ( $\pm 2\%$ )
- the 3rd to the last measured value is between 960 and 1040 Hz ( $\pm 4\%$ )
- the 4th to the last measured value is between 920 and 1080 Hz ( $\pm 8\%$ )
- the 5th to the last measured value is between 840 and 1160 Hz ( $\pm 16\%$ )

**Resolution:**

With very small measured values, especially at the lower measurement limit of the UPL, or in the case of signals with superimposed noise, relatively large measuring errors may occur so that the measured value often is no longer within the exponential tolerance characteristic. In this case, a minimum value of the result resolution is considered, the "resolution" value, which serves as the starting value for an exponential resolution characteristic and which has exactly the same curve (EXPONENTIAL or FLAT) as the exponential tolerance characteristic (see fig. 2-10).

A value outside the exponential tolerance characteristic which has been caused by superimposed noise is not expressive with regard to the transient response of the test item. If the measured value satisfies the resolution entered by the user, however, it is accepted as being valid nevertheless.

If, e.g., the current measured value is not within the tolerance limit required compared to the 4th last result, the amount of the difference between the current measured value and the 4th last value is found and compared to the resolution value no. 4. If this difference value is smaller than the resolution value, the measurement result is considered to be valid.

The accuracy of the phase measurement results is the same throughout the entire range from 0 to 360°. Observing the tolerance for phase measurement results would not be very useful, because the slightest phase fluctuations about 0° would cause large tolerance jumps and thus continuously violate the tolerance conditions. Therefore, only specification of the resolution is possible for the phase measurement, i.e. the absolute offset of the current phase measurement result compared to the previous phase measurement results in °.

**Example:**

Phase measurement with resolution 1°:

A phase result is indicated to be valid if the magnitude of the difference between the current measured value and

- the 1st last measured value  $\leq 1^\circ$
- the 2nd last measured value  $\leq 2^\circ$
- the 3rd last measured value  $\leq 4^\circ$
- the 4th last measured value  $\leq 8^\circ$
- the 5th last measured value  $\leq 16^\circ$

Example by means of the following panel setting:

Settling	EXPONENTIAL
Samples	5
Tolerance	1.0 %
Resolution	0.5 mV

### Tolerance characteristic

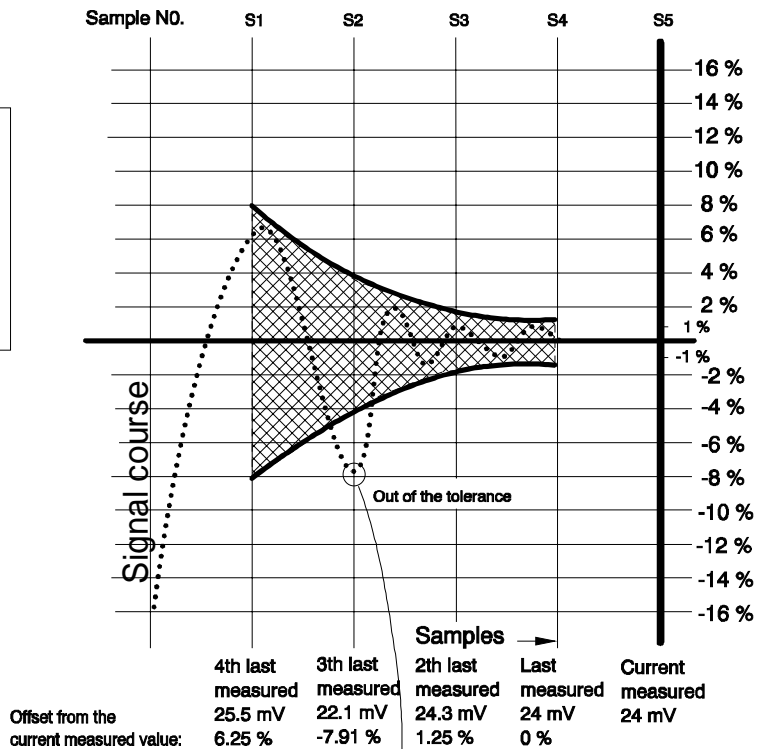

### Resolution characteristic

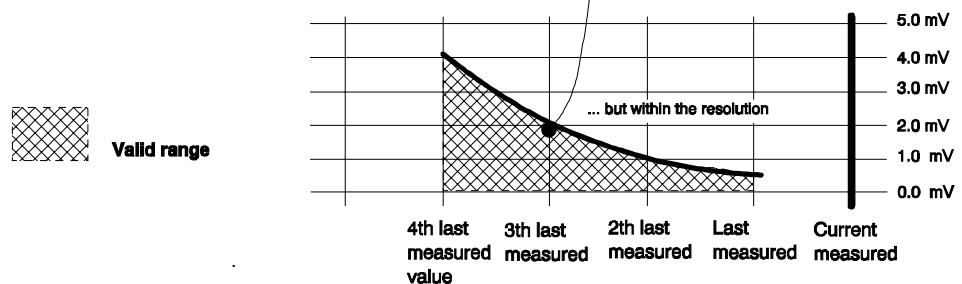

Fig. 2-10 Connection between tolerance and resolution

The EXPONENTIAL traces are always calculated to the basis 2. The sampling points of the exponential tolerance characteristic, e.g. starting from tolerance 1%, are calculated to: 1%, 2%, 4% and 8%. The sampling points of the resolution trace, e.g. starting from a resolution of 0.5 mV, are calculated to: 0.5 mV, 1 mV, 2 mV and 4 mV. The offset of the current measured value compared to the 3rd last measured value is -7.91% and is therefore not within the desired tolerance. When the amount of the difference between the current measured value (24 mV) and the 3rd last measured value (22.1 mV) is smaller than or equal to the resolution value [S2] (2 mV), the current measured value is accepted as being valid nevertheless.

$$|24 \text{ mV} - 22.1 \text{ mV}| = 1.9 \text{ mV}$$

Since 1.9 mV < 2 mV, the current measured value is valid.

**Time-out:**

Time-out denotes the time which may elapse from the start of a measurement until the settling mechanism has recognized a settled measurement result. If the measured value does not stabilize within this time, the measuring loop is aborted and the note "Input - Press SHOW I/O" output instead of a measured value. During a sweep with a graphical curve display, a gap in the curve trace indicates that a measured value is missing. In the case of settling with an external sweep (cf. next paragraph) a time-out is not considered.

**2.3.4.3 Settling Process with External Sweep:**

For better understanding the following explanations, please read menu items

- "Min VOLT"
- "Start"
- "Stop"
- "Variation"

in Section 2.6.4, Ways of Starting the Analyzer, Ext. Sweep

When the external sweep (START COND → FREQ CH1 | FREQ CH2 | VOLT CH1 | VOLT CH2) is used together with the settling process, the following measurement procedure results (see fig. 2-11):

1. Check whether a level of at least the value indicated in "Min VOLT" is present at the measurement input. (Only true of an external sweep with triggering on frequency changes (START COND → FREQ CH1 | FREQ CH2))  
No: Execute step 1.
2. Wait for the stabilization of the frequency with setting: \_\_ START COND → FREQ CH1 | FREQ CH2, or the stabilization of the level with setting: START COND → VOLT CH1 | VOLT CH2 by means of the settling process.
3. Check whether the level or the frequency are in the range indicated by "Start" and "Stop".  
No: Execute step 1.  
Yes: - Wait the time indicated under delay to permit a test item to settle.  
- Execute function measurement (possibly including function settling)  
- Proceed function result to the display
4. Check whether a change in level or frequency by at least the value indicated in "Variation" has occurred.  
No: Execute step 4  
Yes: Execute step 1

**Note on the delay:**

*A delay with an external sweep with settling process is useful when measurement is carried out on test items showing a slow transient response of the level due to a change in frequency (e.g. hearing aids with sound-level limiter or compander/expander circuits with fast level rise times and slow decay times). A frequency change has to be set as a trigger condition (START COND → FREQ CH1 | FREQ CH2). If the settling mechanism supplies quickly steadied values for the frequency results but the level is far from having stabilized, the lapse of the level settling time can be waited for using delay.*



External sweep with settling process example:

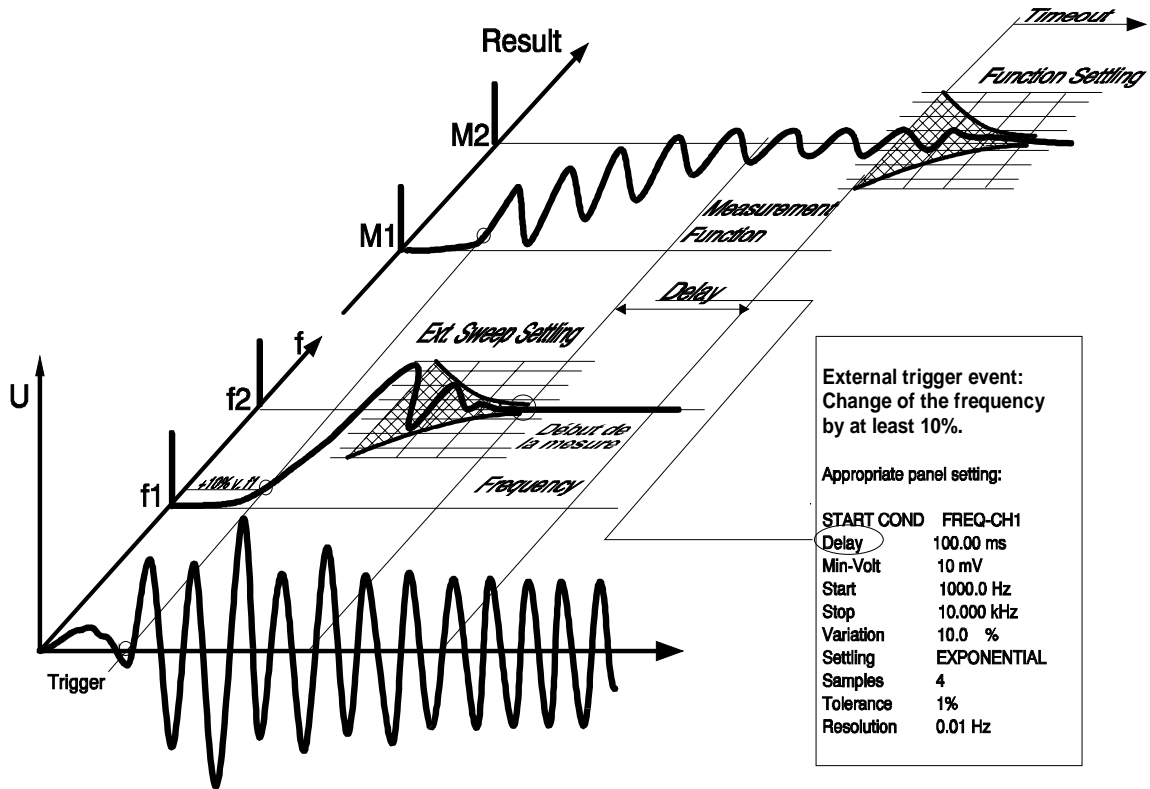

Fig. 2-11 External sweep with settling process

### 2.3.4.4 SETTLING Check and Optimization

#### Settling check

If the SHOW I/O key is pressed during a fault-free measurement run with activated settling process, the settling control characters "r", "t" or "-" appear in a suggested result window or after the text "Ext. Sweep", indicating whether the result display or the trigger event were possible because of a fulfilled tolerance or resolution condition. According to this display, the tolerance or resolution value can be varied until the desired transient response is achieved.

Example of an indication in SHOW I/O display:

	Func		Freq
CH1	rttr		rrt
CH2	tttr		ttt

Ext. Sweep: trt

**Explanation:**

"t": tolerance condition fulfilled

e.g., "t" at the third position: tolerance condition of the current measurement result compared to the 3rd last measurement result was fulfilled.

"r": resolution condition fulfilled, only

e.g., "r" at the fifth position: the tolerance condition of the current measurement result compared to the 5th last measurement result was

not fulfilled, the resolution condition was fulfilled instead.

Exception:

Since no tolerance condition can be specified for the phase measurement, a settled phase measurement result is always characterized by "r".

"-----": No settled measurement result.

Remedy:

- Increase tolerance and resolution value
- Reduce the number of samples
- Switch from FLAT to EXPONENTIAL.

"rrrrr" The measurement result is too unsteady or noisy for the selected tolerance condition.

Remedy:

Select greater tolerance value.

If a still smaller resolution value was selected, "-----" would be displayed.

"rttrt" The measurement result is still too unsteady or noisy for the selected tolerance value.

Remedy:

The more unsteady this display, the greater the tolerance value to be selected.

"ttttt" The measurement results lie all inside the specified tolerance range.

The tolerance condition can be tightened by using a smaller tolerance value or the setting Settling → FLAT until an "r" appears sporadically.

**Note:** *If varying or fluctuating measurement results are to be observed although the tolerance condition is fulfilled, this may be due to the following reasons:*

- Slowly rising or falling measured values (compared to the measurement rate)
- Sudden, but rare variation of the measured values compared to the measurement rate.

**Optimizing the settling parameters:**

In order to obtain maximal measurement rates in connection with the settling mechanism, the DELAY time under START COND → AUTO (cf. 2.6.4) is to be observed. This is the time elapsing from the setting of the generator until the restart of a measurement (and thus the start of the settling process) in order to take into account possible dead times of a test item. The UPL automatically considers the settling time of the generator and the analyzer. If the value 0.0 s is entered for DELAY, no additional delay is effective and a maximum measurement rate is achieved.

As the settling process in the UPL can be used for individual measurements, the suitable settling parameters can be easily determined by observing the measurement results and by trying.

**Delay value if the UPL generator is used**

Measurement of the DUT delay using the time-controlled measurement functions Timetick or Timechart (START COND → TIME TICK or TIME CHART, cf. 2.6.4 Ways of Starting the Analyzer, Ext. Sweep) and graphical display. After a generator modification, determine the time until the sudden signal change.

**Delay value with external sweep**

In the case of unknown signals, short dead times of the test item up to approx. 100 ms can be determined using function WAVEFORM, for longer dead times we recommend to use a storage oscilloscope. If test bands, test CDs etc. are used, possible manufacturer's instructions can be used. Trying delay values for the external sweep is usually not successful since settled measured values might occur, but possibly at an undesired point of time.

**Sample value**

A high value makes high demands on the transient response of the test item. No general statements possible.

**Tolerance value**

Select bar display until the min/max values are within the desired limits. A tolerance indication of 1% is suitable for most AF applications. In the case of noisy test bands with considerable level fluctuations, e.g., the tolerance value must not be selected too small as otherwise settled measured values would never be obtained. Tolerance values of approx. 5% with 3 samples can be useful.

If noisy signals are weighted via the settling process, a steadied readout can be achieved by suitably setting "tolerance". However, the measurement rate decreases as possibly very many measured values have to be rejected until the settling condition is satisfied. The settling process offers the possibility of averaging (cf. AVERAGE).

**Resolution value**

Observe value displayed. The resolution value should always remain near the UPL resolution. If, e.g., the level result fluctuates by 2 mV, a value which is approx. 5 times higher, i.e. 10 mV, would be suitable as resolution value.

**Caution!** *Too high a resolution value would permanently signal settled measured values although the tolerance conditions would permanently be violated.*

**Time-out**

The longest time the UPL takes to measure the test item can be determined by experimenting. If this time is slightly increased, it can be used as time-out period and guarantees a maximal rate of the test run in the case of time-out being exceeded.

**Note:** *For explanation of how to enter settling commands see 2.6.5.1 Common Parameters of Analyzer Functions.*

### 2.3.5 Status Display

The status information is always displayed in the top right section of the screen and contains information on the current status of the generator, analyzer and sweep system as well as date and time.

Exception: In full-screen mode (see 2.10.9 Switching between Full-screen and Part-screen Mode), date and time are displayed right-flush in the operator guidance line.

#### Status display GEN Status

GEN OFF: Both generator channels are off.  
 GEN RUNNING: Generator outputs signal.  
 GEN BUSY: Generator-DSP is temporarily processing the waveform.  
 GEN HALTED: No generator output signal because of the setting not yet concluded or invalid.  
 GEN OVERRUN: The sample rate applied to the external input (see 2.5.3) is too high for the selected digital generator.  
 Remedy: • Set a lower external sample rate. Recall the function.

#### Status display ANL Status

ANL WAIT FOR TRIG: The analyzer waits for the trigger condition set under START COND (see 2.6.4).

ANL1:  2:

Separate status information for analyzer channels 1 | 2:

OFF: Channel OFF, no status messages  
 OVER: Overranges may occur when  
 • a measurement range has been fixed using FIX (see 2.6.2 Configuration of the Analog Analyzers)  
 • a signal with a level featuring a crest factor > 2 is applied to the range limit  
 • DC control is applied to the input configuration BAL.

UNDR: Unterranges may occur when a measurement range has been fixed using FIX or LOWER (see 2.6.2 Configuration of the Analog Analyzers)

RANG: Ranging. No measurements possible!  
 SNGL: Single measurement running   
 CONT: Continuous measurement running see 2.11 Starting and  
 TERM: Single measurement terminated Stopping Measurements  
 STOP: Measurement stopped or Sweeps   
 CAL: Cyclic internal DC offset calibration of A/D converter in the analog analyzers or DC offset calibration of input levels in measurement function DC. Calibration, see 2.15.6.

ORUN: The sample rate applied to the external input (see 2.6.3) is too high for the selected digital instrument.  
 Remedy: • Set a lower external sample rate  
 Recall the function.

**Status display SWP Status after modifications to the settings**

SWP OFF:	No sweep	] see 2.11 Starting and Stopping of Measurements or Sweeps
SWP INVALID:	Sweep invalid because not yet started or parameter varied	
SWP TERMINATED:	Single sweep terminated	
SWP STOPPED:	Sweep was stopped and can be continued	
SWP CONT RUNNING:	Continuous sweep running	
SWP SNGL RUNNING:	Single sweep running	
SWP MANU RUNNING:	Manual sweep running	] see 2.11 Starting and Stopping of Measurements or Sweeps
SWP UNDERRANGE:	On account of an underrange, valid, yet inaccurate measured values occurred during a sweep.	

**Other status displays:**

In the section where date and time is displayed, the following status messages are displayed. Data and time are displayed again when the cause for the error has been removed.

- PRINTER NOT READY
- After the H COPY key has been pressed, the UPL recognizes that no printer is connected.
  - The connection to the printer has been interrupted while files or lists (see 2.14.1 and 2.14.5) are being printed.
- CONVERTING SETUP
- The setup of a previous UPL program version is being converted to be loadable by the latest UPL program version.
- WAIT FOR CAL: ANA OFFSET
- The analyzer requires an offset calibration. It is currently not feasible because cyclic DC-offset calibration has been switched off (see 2.15.6) or, due to a running sweep, has been disabled.

The operator guidance line shows the following status message:

DUMP SCREEN TO TEMPORARY FILE Pressing the H COPY key causes the screen contents to be copied to a temporary file. While this status message is being displayed, operation of the UPL is not possible.

### 2.3.6 Error Messages

Each error message in manual mode is displayed in a window in the center of the screen until it is confirmed by the user. This can be done in three different ways:

1. By pressing the ENTER key of the UPL keyboard. This is recommended if the entry causing the error message was made via the UPL keyboard.
2. By operating the rollkey of the UPL. This is recommended if the entry causing the error message was also made via the rollkey. It is therefore not necessary to press the ENTER key while using the rollkey.
3. By pressing the RETURN key of the external keyboard connected. This is recommended if the entry causing the error message was made via the external keyboard.

The error message contains information about troubleshooting, if possible.

#### Error messages in measurement mode

In measurement mode, error messages may occur on account of inappropriate input signals or settings, thus disabling the display of measured values. Instead, the following hint is displayed in the window:

-INPUT ?-  
Press SHOW I/O

Fulfilling this request by pressing the SHOW I/O key on the UPL front panel (or ALT + I on the keyboard) sets a graphics to show the currently active inputs/outputs (see 2.12) and a text giving information about why the display of measured values is not possible. If there are more than one message, the messages can be called one after the other by repeatedly pressing the SHOW I/O key. Messages issued more than 30 seconds ago are not displayed.

The UPL front-panel graphics is removed and the measurement mode is entered again when

- all messages have been read out and the SHOW I/O key is pressed again.
- CANCEL or ESC is pressed.

#### Fatal errors with error messages

Just in case an internal software error making it impossible for the UPL program to run should occur, which is never to happen, the DOS operating system is branched to. The following error message will be displayed.

*"Save setup to C:\UPL\SETUP\UPL.SET and Exit to DOS!"*

"Internal Error No. xxx -- press any key!" where xxx is the error number.

Before returning to the DOS operating system, the current setup and a fault diagnostics buffer including the error number xxx is stored from the battery-backed RAM of the UPL to the hard disk under the name C:\UPL\SETUP\UPL.SET.

You can facilitate troubleshooting for the R&S service personnel by including the UPL.SET file.

To this end, connect a keyboard to the UPL (see 1.1.6 Connecting an External Keyboard), insert a 3½"-disk into the disk drive and enter the DOS command:

```
COPY C:\UPL\SETUP\UPL.SET A:
```

When the UPL is put into operation again after a fatal error, the power-up picture includes the hint "Error in prev. run! CANCEL → default setting, ENTER → previous setting" offering you the following possibilities

- CANCEL: ... booting the UPL with its default setting
- ENTER: ... booting the UPL with the previous setting which might be faulty.

**Fatal errors without error message**

In the case of a fatal error without error message, the UPL was no longer capable of storing the information which provides the above selection box when the UPL is put into operation again. Analogous to the above selection box, you can select between two ways of starting the UPL.

Booting the UPL with the setup most recently stored in the CMOS-RAM

This setup may be correct despite the faulty response of the UPL. To avoid having to re-enter the settings most recently input, try to start the UPL with this setup.

- Switch power switch off and on (no further action necessary).

In case the above attempt fails,

boot the UPL

Enter the following and terminate with ENTER:

UPL -d	The setup "DEFAULT.SET" supplied with the UPL in the directory C:\UPL\SETUP is loaded.
UPL -s	The UPL is started with the setup given without space character following "-s". The file name should be combined with a path name, e.g.: -sA:\SETUP\MYSETUP.SET ODER -sC:\UPL\USER\MYSETUP.SET (The file names are given by way of example.)

### 2.3.7 Help Function

#### Calling the HELP function:

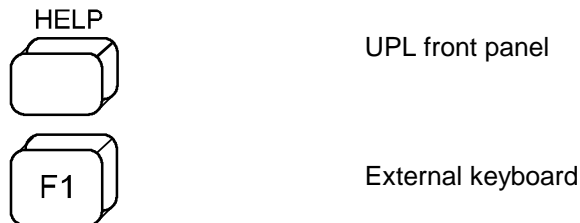

A HELP information can be called for any input field in the panels (context-sensitive). It is displayed in a window in the center of the screen. Depending on the size of the HELP information, waiting times of several seconds may occasionally occur, which is indicated by the note

*Just a moment please!*

If the HELP information extends the range provided in the window, paging is possible by way of the Page ↑ and Page ↓ keys. A scroll bar at the right margin of the window indicates the position of the visible text section with respect to the complete HELP information. Highlighted fields within the HELP information serve as cross-references for a more detailed description. Cross-reference information is selected using the ↑, ↓, →, ← keys and displayed using SELECT. The HELP window is used and scrolled in the same way as is a panel (see 2.3.1 Panels).

Requesting a HELP information stops the output of graphics.  
Measurement results can still be output.

#### Selection of the language

The help text can either be displayed in German or English language. The languages can be selected in the OPTION panel under the menu item Language (cf. 2.15.4)

#### Help information on the graphics softkeys:

By calling the help function with active part or full display, the user obtains the help information on the graphics softkeys.



**2.3.8 Simplification of Panels**

The UPL and UPD menu lines are arranged in the same way in all the panels. This means the UPL or UPD user works in a familiar environment with any unit and in any setup.

However, this also has the effect that some menu lines – which are important for certain applications – are located down at the bottom outside the visible window. Vice versa, menu lines that may not be needed for the application on hand are located further up, taking up all the space in the visible range.

For this reason, the panels for particular UPL/UPD applications can be simplified by clearing the visible range from menu lines that are momentarily not required. Every panel can be modified such that the 18 most important menu lines are arranged in the upper range which is visible in the panel window.

When a menu line is eliminated, a new section labelled "Hidden Commands" appears at the end of the panel, which now contains the eliminated menu line. If several menu lines are eliminated, they will be arranged in this section in the same order as in the upper range of the panel. Of course, the hidden menu lines can still be used and may also be restored to their original positions whenever desired.

Each menu line can be hidden and restored via the associated check box.

Action	Key on UPL keyboard	Key on external keyboard	UPL response
Hiding	BACKSPACE	BACKSPACE or DEL	Menu line is moved to "Hidden Commands" section
Restoring	BACKSPACE	BACKSPACE or INS	Menu line is moved back to original position

**Note:** *If all menu lines of a panel have been restored, the empty "Hidden Commands" section will disappear.*

If an external keyboard is connected, the "Hidden Commands" sections of the panels can be temporarily "hidden" by pressing CTRL H. This is not stored in the device setup, ie when the unit is started anew, the "Hidden Commands" are again visible. While the unit is on, the "Hidden Commands" are made visible again by pressing CTRL H a second time.

**Note:** *The status panel does not contain a "Hidden Commands" section. By pressing the BACKSPACE key, the menu lines in the original panel are hidden or restored. The status panel is reduced by switching off the tick for the menu lines that are currently not needed.*

## 2.4 Units

There are two types of units available in the UPL:

- Units for the display of measurement results:  
Select a display unit for every measurement function in the ANALYZER panel. The measurement result will be displayed with this unit in the measured value window (see 2.3.3 Display of Measured Values). The unit is selected under the menu item "UNIT" of the respective measurement function subsequent to opening the window.
- Units for the input of values (e.g. reference values, frequencies, level etc.). While data are entered, all appropriate units are offered on the softkeys thus enabling termination of the value entry by selection of the unit. Opening of the selection window is not required (cf. 2.3.2.2 Entry of Numerical Data).

### 2.4.1 Units for the Display of Measurement Results

To simplify the matter

- the data to be entered are designated in the conversion formulae below with their unit, only.  
Example: "dBu" means: value in dBu.
- the conversions into  $\mu$ , m, k, M are omitted

#### Units for analog level measurement results:

Functions: RMS & S/N, RMS Select, PEAK, QPEAK, DC, Input-Disp: PEAK, Input Disp: RMS  
Basic unit: Volt (V[V])

Table 2-2 Units for analog level measurement results

Value in	IEC/IEEE-bus notation	Conversion formula
V	V	
dBV	DBV	$20 * \lg(V)$
dBu	DBU	$20 * \lg(V/0.7745967)$
dBm	DBM	$10 * \lg(V^2 * 1000 / R_{REF})$
W	W	$V^2 / R_{REF}$
$\Delta\%V$	CPCTV	$(V/U_{REF} - 1) * 100$
$\Delta V$	DV	$V - U_{REF}$
V/Vr	VVR	$V / U_{REF}$
$\%V/Vr$	PCTVVR	$100 * V / U_{REF}$
$\Delta\%W$	DPCTW	$((V^2 / R_{REF}) - P_{REF}) / P_{REF} * 100$
$\Delta W$	DW	$(V^2 / R_{REF}) - P_{REF}$
P/Pr	PPR	$(V^2 / R_{REF}) / P_{REF}$
$\%P/Pr$	PCTPPR	$(V^2 / R_{REF}) / P_{REF} * 100$
dB	DBR	$20 * \lg(V / U_{REF})$

$R_{REF}$  = Value of reference impedance from ANALYZER panel

$V_{REF}$  = Reference value from ANALYZER panel of functions RMS & S/N, RMS-SELECT, PEAK, QPEAK, DC or Input PEAK/RMS measurement

$P_{REF}$  =  $(U_{REF})^2 / R_{REF}$

**Units for digital level measurement results:**

Functions: RMS & S/N, RMS-Select, PEAK, QPEAK Input-Disp: PEAK, Input Disp: RMS

Basic unit: Full Scale FS 0 to 1

Table 2-3 Units for digital level measurement results

Value in	IEC/IEEE-bus notation	Conversion formula
FS	FS	
%FS	PCTFS	FS×100
dBFS	DBFS	20 × log (FS)
Hex *)	HEX	FS×65535
Δ%	DPCT	(FS/U <sub>REF</sub> -1) × 100
dBr	DBR	20 × log (FS/U <sub>REF</sub> )
LSBs	LSBS	FS × 2 <sup>audio bits-1</sup>
bits	BITS	ld (FS × 2 <sup>audio bits-1</sup> + 1)

V<sub>Ref</sub> = Reference from the ANALYZER panel of the functions RMS & S/N, RMS-SELECT, PEAK, QPEAK, DC or Input-PEAK/RMS measurement

\*) Level measurement result in hex

The full-scale (FS) value measured at the digital interface as the result of a digital analyzer function is displayed as a 6-digit hexadecimal number (6 digits= 24 bit = 23 bit mantissa +1 sign bit) in the measured value window, for example:

Table 2-4 Level measurement results FS/Hex

FS value	Hex display
1.0	7FFFFFF Hex
0.9	733333 Hex
0.5	400000 Hex
0.0001	000347 Hex
0.0	000000 Hex
-0.0001	FFFCB9 Hex
-0.5	C00000 Hex
-0.9	8CCCCD Hex
-1.0	800000 Hex

All digital analyzer functions provide FS values in the range from 0 to 1. Exception: the peak measurement functions PEAK & S/N and Q-PK & S/N may provide FS values < 0 or >1, depending on the PEAK mode selected. All values < -1 and >1 are displayed as 80000 Hex and 7FFFFFF Hex, respectively.

FS values > 1 may occur

- with the function PEAK & S/N together with Meas Mode PK+, when applying a square signal. Being band-limited, overshoots at the edges (Gibb's phenomenon) occur, which, with peak evaluation, are included as part of the measurement result.
- with the measurement function PEAK & S/N together with Meas Mode PK to PK or PKabs.

FS values < 0 may occur

- with the function PEAK & S/N together with Meas Mode PK-.

**Units for analog and digital interference level measurement results:**

Functions: THD, THD+N/SINAD, MOD DIST, DIM, DFD

Basic unit: %

Table 2-5 Units for analog and digital interference level measurement results

Value in	IEC/IEEE-bus notation	Conversion formula
%	PCT	
dB	DB	$20 * \log ([\%] * 100)$

**Unit for analog and digital S/N measurement results:**

Functions: RMS, PEAK, QPEAK with S/N measurement on

Table 2-6 Unit for analog and digital S/N measurement result

Value in	IEC/IEEE-bus notation	Conversion formula
dB	DB	$20 * \log(S/N)$

S: Measured level with generator on

N: Measured level with generator off

**Units for analog and digital frequency measurement results:**

Basic unit: Hz

Table 2-7 Units for analog and digital frequency measurement results

Value in	IEC/IEEE-bus notation	Conversion formula
Hz	HZ	
$\Delta$ Hz	DHZ	$\text{Hz} - F_{\text{REF}}$
$\Delta\%$ Hz	DPCTHZ	$100 * (\text{Hz} - F_{\text{REF}})/F_{\text{REF}}$
Toct *	TOCT	$\log (\text{Hz}/F_{\text{REF}}) * 9.96578$
Oct	OCT	$\log (\text{Hz}/F_{\text{REF}})/0.30103$
Dec	DEC	$\log (\text{Hz}/F_{\text{REF}})$
f/fr	FFR	$\text{Hz}/F_{\text{REF}}$

\*) Toct = Third Octave

 $F_{\text{Ref}}$  = Reference parameter from ANALYZER panel of frequency measurement**Units for phase measurement results:**

Basic unit: degree

Table 2-8 Units for phase measurement results

Value in	IEC/IEEE-bus notation	Conversion formula
°	DEG	
RAD	RAD	$P[^\circ] * (\pi/180)$
$\Delta$ °	DDEG	$P[^\circ] - D_{\text{REF}}$
$\Delta$ RAD	DRAD	$(P[^\circ] - D_{\text{REF}}) * (\pi/180);$

 $D_{\text{Ref}}$  = Reference parameter from ANALYZER panel of phase measurement

**Units for group-delay measurement results:**

Basics unit: s

Table 2-9 Units for group-delay measurement results

Value in	IEC/IEEE-bus notation	Conversion formula
s	S	
$\Delta s$	DS	$\tau[s] - D_{REF}$

$D_{REF}$  = Reference parameter from ANALYZER panel of phase measurement

**Unit for analog and digital wow & flutter measurement results:**

Basic unit: %

Table 2-10 Units for analog and digital wow & flutter measurement results

Value in	IEC/IEEE-bus notation	Conversion formula
%	PCT	

**Unit for digital jitter measurement results:**

Basic unit: UI

Table 2-11 Unit for digital jitter measurement results

Value in	IEC/IEEE-bus notation	Conversion formula
UI	UI	
%UI	PCTUI	$100 \times UI$
dBUI	DBUI	$20 \times \log (UI)$
ppm	PPMUI	$10^6 \times UI$
ns	NS	$10^9 \times UI / (128 \times \text{sample frequency})$
dBr	DBR	$20 \times \log (UI/U_{REF})$

**Unit for digital phase measurement results (PhaseToRef):**

Basic unit: UI

Table 2-12 Unit for digital phase measurement results

Value in	IEC/IEEE-bus notation	Conversion formula
UI	UI	
%FRM	PCTFRM	$100 \times UI / 128$
°FRM	DEGFRM	$360 \times UI / 128$
ns	NS	$10^9 \times UI / (128 \times \text{sample frequency})$

Jitter and delay are usually stated in UI (unit interval). UI is defined as the smallest pulse width of the digital audio signal (eye width) and is independent of the selected sampling rate. One UI corresponds to the clock period of the digital signal (biphase clock). With digital audio signals, one UI corresponds to the 128th of the sampling period; at 48 kHz one UI is approx. 163 ns.

## 2.4.2 Units for the Entry of Values

To simplify the matter

- the input values are designated only by the unit in the following conversion formulas.  
Example: "dBu" actually means "value in dBu".
- the conversions into  $\mu$ , m, k, M have been left out.

Table 2-13 Absolute analog level units (without reference voltage)

Conversion formulae	IEC/IEEE-bus notation
$V_{pp}$ = depending on the generator function (see 2.5.4 for respective signal function)	VPP, VPP, UVPP
$dBu = 20 \cdot \log(V/0.7746)$	DBU
$V = 0.7746 \cdot 10^{(dBu/20)}$	
$dBV = 20 \cdot \log(V)$	DBV
$V = 10^{(dBV/20)}$	
$dBm = 10 \cdot \log(V^2 \cdot 1000/R_{REF})$	DBM
$V = \sqrt{10^{(dBm/10)} \cdot R_{REF} / 1000}$	
$W = V^2/R_{REF}$	W, mW, uW
$V = \sqrt{(W \cdot R_{REF})}$	

\*) For the generator, the reference impedance is fixed to  $R_{REF} = 600 \text{ ohm}$ .

Table 2-14 Relative analog level units (with reference voltage)

Conversion formulae	IEC/IEEE-bus notation
$\Delta V = V - U_{REF}$	DV, Dm, V, DuV
$V = \Delta V + U_{REF}$	
$\Delta\%V = (V/U_{REF} - 1) \cdot 100$	DPCTV
$V = U_{REF} \cdot (1 + \Delta\%V/100)$	
$V/V_r = V/U_{REF}$	VVR
$V = V/V_r \cdot U_{REF}$	
$\%V/V_r = V/U_{REF} \cdot 100$	PCTV/VR
$V = \%V/V_r \cdot U_{REF}/100$	
$\Delta W = (V^2 - U_{REF}^2)/R_{REF}$	DW
$V = \sqrt{(dW \cdot R_{REF}) + U_{REF}^2}$	
$\Delta\%W = (V^2 - U_{REF}^2) \cdot 100/U_{REF}^2$	DPCTW
$V = \sqrt{U_{REF}^2 \cdot (\Delta\%W / 100 + 1)}$	
$P/Pr = V^2/U_{REF}^2$	P/PR
$V = \sqrt{P/Pr \cdot U_{REF}^2}$	
$\%P/Pr = V^2/U_{REF}^2 \cdot 100$	PCTPPR
$V = \sqrt{\%P/Pr \cdot U_{REF}^2 / 100}$	
$dBr = 20 \cdot \log(V/U_{REF})$	DBR
$V = 10^{(dBr/20)} \cdot U_{REF}$	
$V/on = V/Burstamp[V]$	V/VON
$V = V/on \cdot Burstamp[V]$	
$\%on = 100 \cdot V/Burstamp[V]$	PCTON
$V = \%on \cdot Burstamp[V]/100$	
$dBon = 20 \cdot \log(V/Burstamp[V])$	DBON
$V = 10^{(dBon/20)} \cdot Burstamp[V]$	

Table 2-15 Absolute digital level units (without reference)

Conversion formulae	IEC/IEEE-bus notation
$bits = -3.322 \cdot \log(FS)$	BITs
$FS = \frac{2^{bits}-1}{2^{Audio\ bits-1}}$	
$\%FS = 100 \cdot FS$	PCTFS
$FS = \%FS/100$	
$dBFS = 20 \cdot \log(FS)$	DBFS
$FS = 10^{(dBFS/20)}$	
$LSBS = FS \cdot 2^{Audio\ bits-1}$	LSBS
$FS = \frac{LSBS}{2^{Audio\ bits-1}}$	

Table 2-16 Relative digital-level units (with reference)

Conversion formulae		IEC/IEEE-bus notation
$dBr = 20 \times \log (FS/U_{REF})$	$FS = 10^{(dBr/20)} \times U_{REF}$	DBR
$\Delta\% = 100 \times (FS/U_{REF} - 1)$	$FS = (\Delta\% / 100 + 1) \times U_{REF}$	DPCT
$\%on = 100 \times FS/Burstamp[FS]$	$FS = \%on \times Burstamp[FS]/100$	PCTON
$dBon = 20 \times \log (FS/Burstamp[FS])$	$FS = 10^{(dBon/20)} \times Burstamp[FS]$	DBON

Table 2-17 Absolute time units

Conversion formula		IEC/IEEE-bus notation
s		S, MS, US
min = 60 s	s = min / 60	MIN
cyc = s * signal frequency	s = cyc / signal frequency	CYC, KCYC, MCYC

Table 2-18 Relative time units

Conversion formula		IEC/IEEE-bus notation
$\Delta s = s - T_{REF}$	$s = \Delta s + T_{REF}$	DS, DMS, DUS
min = 60 s	s = min / 60	MIN
cyc = s * signal frequency	s = cyc / signal frequency	CYC, KCYC, MCYC

Table 2-19 Absolute frequency units

Conversion formula		IEC/IEEE-bus notation
Hz		HZ KHZ

Table 2-20 Relative frequency units (with reference)

Conversion formulae		IEC/IEEE-bus notation
$\Delta Hz = Hz - F_{REF}$	$Hz = \Delta Hz + F_{REF}$	DHZ, DKHZ
$f/fr = Hz/F_{REF}$	$Hz = f/fr * F_{REF}$	FFR
$\Delta\%Hz = 100 * (Hz - F_{REF})/F_{REF}$	$Hz = \Delta\%Hz * F_{REF}/100 + F_{REF}$	DPCTHZ
$Toct^*) = \lg (Hz/F_{REF}) * 9,96578$	$Hz = 2^{(Toct/3)} * F_{REF}$	TOCT
$Oct = \lg (Hz/F_{REF}) * 3,32193$	$Hz = 2^{(Oct)} * F_{REF}$	OCT
$Dec = \lg (Hz/F_{REF})$	$Hz = 10^{(Dec)} * F_{REF}$	DEC
*) Toct = Third Octave = Terz		

Table 2-21 Absolute phase unit

Conversion formula		IEC/IEEE-bus notation
$\text{rad} = \text{°} \cdot (\pi/180)$	$\text{°} = \text{rad} \cdot (180/\pi)$	RAD

Table 2-22 Relative phase unit

Conversion formula		IEC/IEEE-bus notation
$\Delta \text{°} = \text{°} - D_{\text{REF}}$	$\text{°} = \Delta \text{°} + D_{\text{REF}}$	DDEG
$\Delta \text{RAD} = (\text{°} - D_{\text{REF}}) \cdot (\pi / 180)$	$\text{°} = (\Delta \text{RAD} \cdot 180 / \pi) + D_{\text{REF}}$	DRAD

Table 2-23 Deviations (tolerance) compared to the previous measured values in the settling function (see 2.3.4 and 2.6.5.1)

Conversion formula		IEC/IEEE-bus notation
$\% = (10^{\text{dB}/20} - 1) \cdot 100$	$\text{dB} = 20 \cdot \lg (\% / 100 - 1)$	DB, PCT

Table 2-24 Step size of a logarithmic level sweep

Conversion formula		IEC/IEEE-bus notation
$\text{MLT} = 10^{\text{dB}/20}$	$\text{dB} = 20 \cdot \log (\text{MLT})$	MLT, DB

Table 2-25 Absolute resistance unit

Conversion formula		IEC/IEEE-bus notation
$\Omega$		OHM, KOHM

**Legend:**

FS:	Abbreviation for Full Scale = ratio 0 to 1
$U_{\text{REF}}$ :	Level reference value in V or FS $\rightarrow$ *)
$R_{\text{REF}}$ :	"Ref Imped" parameter from ANALYZER panel
$F_{\text{REF}}$ :	Frequency reference value in Hz
Burstamp:	High level of generator burst signal, see 2.5.4.5 SINE BURST
Signal frequency:	Frequency of generator burst signal or pulse signal, see 2.5.4.5 BURST, 2.5.4.6 SINE2 BURST
$D_{\text{REF}}$ :	Phase reference value in $\times$
MLT:	Multiplication factor (marked by "*" in the panel)



## 2.5 Generators (GENERATOR Panel)

### Activating the GENERATOR panel:

- *UPL front panel:* GEN
- *External keyboard:* ALT + G
- *Mouse:* (repeated) clicking of the panel name, until the generator panel is displayed.

If the GENERATOR panel is already visible on the screen, it can be activated also by actuating one of the TAB keys (repeatedly) or by mouse-click.

Advantage: The panel need not be established again.

- The GENERATOR panel is always displayed on the left side of the screen and consists of two segments: configuration and function.

GENERATOR		
GENERATOR	DIGITAL	Select instrument (analog or digital).
CHANNEL(s)	CH1	Configuration segment for setting the outputs. (output connectors, channel select, output impedance / sample frequency, etc.)
:	:	see 2.5.2 Configuration of the Analog Generator
:	:	see 2.5.3 Configuration of the Digital Generator
:	:	
FUNCTION	SINE	Functions (waveforms) of the Generator, see 2.5.4
:	:	

When changing the *function* (generator signal)

- the current function is stored to the hard disk;
- the desired function is loaded from the hard disk, initialized and, if possible, started.

When changing the *generator* (e.g. **DIGITAL** instead of **ANLG**)

- the current generator with all settings and the current function is stored to the hard disk;
- the desired generator with the currently active function is loaded from the hard disk, initialized and, if possible, started.

**Note:** *The “parameter link“ function which can be selected in the OPTION panel may be used to influence the UPL with changes of function and instrument. As requested, existing settings in the function and/or configuration segment of the generator panel are accepted for the new function or instrument - if physically possible. A change of instrument from ANLG to DIGITAL can be performed by way of example without the function and its frequency parameters changing in the panel.*

## 2.5.1 Selecting the Generator

### GENERATOR

#### ANLG

#### DIGITAL

The GENERATOR panel contains the settings for the analog and the optional digital generators.

Two-channel analog generator, frequency range:

- 2 Hz to 21.75 kHz with universal generator
- 10 Hz to 110 kHz low-distortion generator (UPL-B1 option)

Two-channel digital generator, frequency range:

- 2 Hz to 21.93 kHz with option UPL-B2 (digital audio I/O)
- 2 Hz to 43.86 kHz with option UPL-B29 (digital audio 96 kHz)

The standard analog generator can be supplemented by the Low-distortion Generator option (UPL-B1) for sinewave generation in the analog range, thus allowing for generating a particular low-distortion sinewave signal with a frequency of up to 110 kHz.

- Frequency range of the digital GENERATOR

The maximum generator output frequency is given by:

$$f_{max} = \text{sample frequency} \times 117 / 256$$

The sample frequency is set in the configuration segment of the GENERATOR panel using the menu item Sample-Frq.

There are 3 states the active generator (visible in the panel) can assume (see 2.3.5 Status Display):

- **RUNNING:** The set function (generator signal) is output via the specified interface.
- **BUSY:** Generator output signal is calculated.
- **HALTED:** Generator is halted, no output signal; the outputs are terminated.

RUNNING, i.e. a signal is constantly output, is the normal status of the generator. It is automatically restarted after a generator reset.

The generator can be manually restarted at all times by calling the generator or the function (open the respective selection window and confirm using ENTER). This may be required with burst signals to enable beginning of a new interval (with the burst phase).

The setting of some signals (e.g. specific noise signals) involves a lot of computations. During this time, the generator does not produce any signal and is in the BUSY state. After having successfully concluded the computations, the generator automatically re-enters the RUNNING state. If further settings are made or keys are pressed during computation, the computation is aborted and automatically restarted. The generator shortly assumes the HALTED state.

Other reasons for halting the generator (HALTED):

- Faulty setting (e.g. wrong file name for an equalization or sweep list).  
Remedy: eliminate the cause of error; restart, if required.
- On the digital instrument:  
Applying a too high external frequency (generator is "overrun").  
Remedy: reduce the external clock frequency and restart.

### 2.5.2 Configuration of Analog Generator

The generator can be used as balanced or unbalanced source with one or two output channels. Various internal resistors are selectable.

The complete generator is designed to be floating to frame potential.

The below overview of possible settings is followed by substitute circuit diagrams showing the three balanced and unbalanced output.

Channel(s)	
OFF	The deactivated channel is internally terminated with the internal impedance set. both channels off
1	channel 1 on, channel 2 off
2	channel 2 on, channel 1 off
2 ≡ 1	identical signal on both channels

Output	
UNBAL	The XLR connectors can be operated either balanced (BAL) or unbalanced (UNBAL). an unbalanced signal is generated at the XLR connector; the maximum output level is 10 V.
BAL	a balanced signal is generated at the XLR connector; the maximum output level is 20 V. The output impedance can be selected in 3 steps. I

Impedance	
10 Ω 200 Ω (150 Ω) 600 Ω	Selection of generator source impedance with Output BAL selected.  The possibility for selecting a generator source impedance of <b>150 Ω</b> is offered when the standard generator source impedance of 200 Ω is changed to 150 Ω by means of Modification Analog Generator UPL-U3 (Order No. 1078.4900.02).  The output impedance of an unbalanced output is generally 5 Ω.

<b>Volt Range</b>
-------------------

<b>AUTO</b>
-------------

<b>FIX:</b>
-------------

The selected voltage range determines the setting of the generator source impedance.

The internal signal paths are driven at maximum level, the output voltage is set with the aid of the output amplifier.

**Advantage:** optimum noise and THD values for measurements with constant level, e.g. frequency sweep.

In the next menu line under "Max Volt" a maximum voltage can be entered; voltages higher than those specified here are *not permissible*.

The output amplifier is set to the specified maximum voltage. The actual output voltage is obtained from small digital values on the D/A converter. When the output voltage changes, setting the analog hardware is not required. **Advantages:** no voltage drops on attenuator switchover. Faster level changes and better transient response for measurements with slight level variations, e.g. frequency sweep using an equalization file. (This setting should be used for loudspeaker measurements).

Enter the numeric value of the voltage range in the next menu line; voltages higher than those specified here are *not possible*.

**Note:** *This setting is ignored when the low-distortion generator option (UPL-B1) is used. Level control of the low-distortion generator is always performed in line with the AUTO algorithm.*

<b>Max Volt</b>
-----------------

Limit value for the output voltage; prevents the inadvertent entry of exceeded voltage values.

The RMS value for sinewave signals is entered, i.e. the peak value of Max Volt is  $\sqrt{2}$  times higher.

<b>Ref Freq</b>
-----------------

Reference value for relative frequency units.

A change of the reference frequency causes all reference-related frequency settings to be changed.

The relative frequency of the generator signal is retained.

For instance, by varying the reference frequency the fundamental of a distortion spectrum set by means of a multisine signal may be shifted without the harmonics having to be recalculated and reset by the user.

**Note:** *If a generator frequency sweep is active ("X-Axis FREQ"), and AUTO scaling has been selected in the DISPLAY panel for the X axis, the reference value will be used as the Y-axis reference value in the DISPLAY panel when a new value is entered.*

**Ref Volt**

Reference value for the relative voltage units.  
 A change of the reference level causes all reference-related voltage inputs to change.  
 The relative voltage of the generator signal is retained.  
 Varying the reference voltage may, e.g., shift a level sweep defined by relative start and stop levels by a constant "gain factor".

**Note:** *If a generator level sweep is active (X-Axis VOLT) and AUTO scaling has been selected in the DISPLAY panel, the reference value will be used as the X-axis reference in the DISPLAY panel when a new value is entered.*

**2.5.2.1 Unbalanced Output (Output UNBAL)**

The unbalanced output signal is applied between pin 2 (hi) and pin 3 (lo) of the XLR connector.

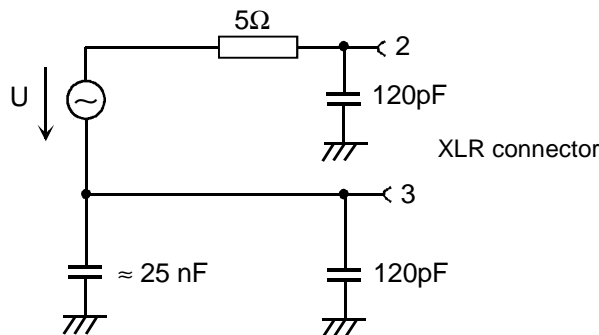
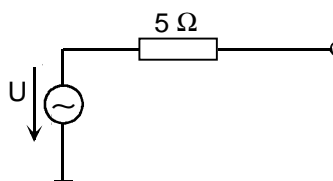

Fig. 2-12 Unbalanced output

Depending on the selected channel setting, the following output circuits are possible (capacitances are omitted):

**Channel(s)**  
**1 or 2**



Channel(s)

2 ≡ 1

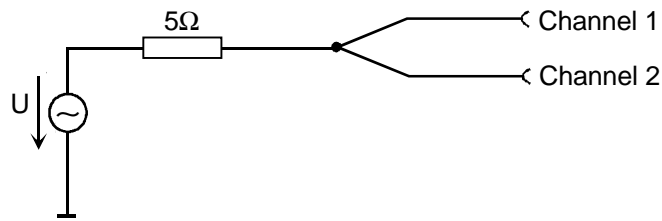

Fig. 2-13 Unbalanced output

### 2.5.2.2 Balanced Output (Output BAL)

The output signal is applied between contacts 2 and 3 of the XLR female connector. The source impedance is presented by two equal resistors, one in each signal line.

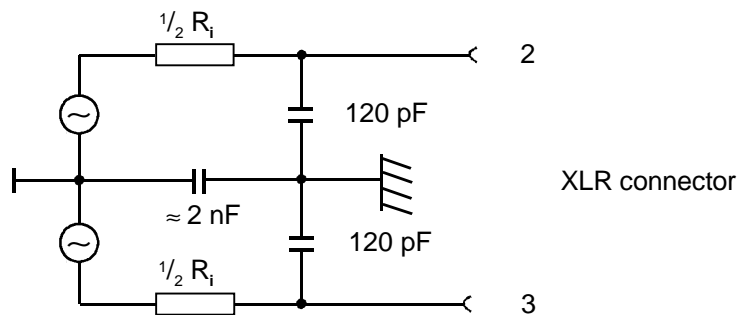
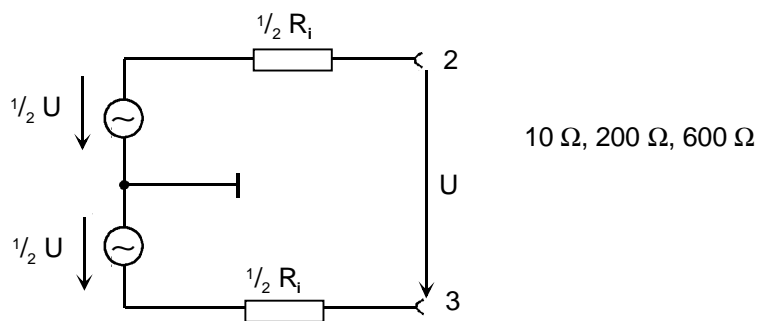

Fig. 2-14 Balanced output

Depending on channel and impedance, the following output circuits are obtained. (Capacitances are not included in the figure):

Channel(s)

1 or 2



Channel(s)

2 = 1

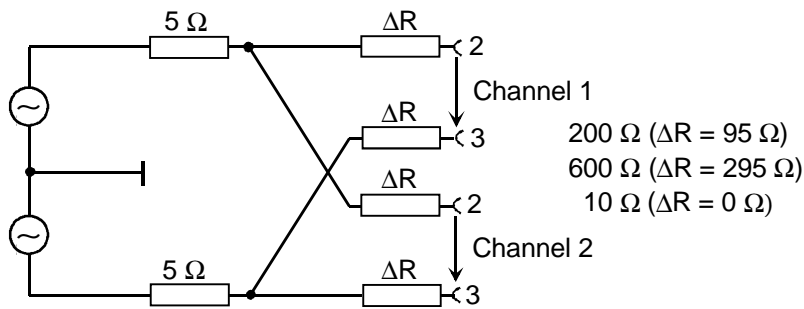

Fig 2-15 Balanced output

### 2.5.2.3 Output Power

The output amplifier, attenuator and all internal resistors are short-circuit proof. The peak current is limited to about 200 mA. With a maximum rms value of the output voltage of 20 V balanced and 10 V unbalanced, the maximum power loss in the load resistor (with a short-circuit in the internal resistor) is 2.8 W or 1.4 W.

Delicate devices under test might be damaged or even destroyed by an output voltage inadvertently selected too high. For this reason, the maximum settable voltage can be limited (Max Volt).

### 2.5.3 Configuration of the Digital Generator

<b>Src Mode</b>	(Source Mode); indicates what is to be generated at the digital interfaces.
<b>AUDIO DATA</b>	The function generator generates digital audio data. An analog jitter signal produced by the auxiliary generator (AUX GEN) or a common signal can be added to the audio data stream. The audio signal is available at all digital interfaces.
<b>JITTER</b>	The function generator generates an analog jitter signal. All frequency and level settings refer to the jitter signal, the audio data remain constant. The audio signal is available at all digital interfaces.
<b>PHASE</b>	Like AUDIO DATA, the frame phase of the audio data stream to the REF output (rear of instrument) can be set. The user-defined phase depends on the following conditions Sync To: GEN CLK only Sync Out: <b>not</b> SYNC PLL Ref Out: REF GEN only Jitter Ref: GEN CLK only (ANALYZER panel)  <b>Note:</b> <i>Although an audio signal can also be generated under this menu, PHASE should only be selected if the definable phase reference is required.</i>
<b>COMMON ONLY</b>	A balanced analog signal is superimposed onto the audio data stream on the two lines of the XLR connector. All frequency and level settings refer to the analog common signal, the audio data remain constant. The common-mode signal is available at the BAL digital interfaces only.
<b>PhaseToRef</b>	Displayed only, if PHASE has been selected as source mode. Setting of the frame phase between the digital audio output and the REF output (rear). Specified range: -64 UI to +64 UI (corresponds to -180° to +180°). Units: UI   %FRM   °FRM   ns
<b>Unbal Out</b>	indicates what is applied to the UNBAL (BNC) output.
<b>AUDIO OUT</b>	The <i>generated</i> AUDIO data are present (also at BAL (XLR) and optical output).
<b>AUDIO IN</b>	The digital AUDIO data received (at the UNBAL or BAL input) are present (front panel), e.g., an oscilloscope for examining the input signal may be connected here.



<p><b>Cable Sim</b></p>	<p>(Cable Simulation)</p> <p>A cable length of approx. 100 m can be simulated at the UNBAL (BNC) or BAL (XLR) outputs.</p> <p>Cable simulation switched off.</p> <p>Cable simulation switched on for both electrical outputs (BAL and UNBAL).</p> <p><b>Note:</b> Cable simulation is effective even if the AUDIO IN signal is applied to the UNBAL (BNC) output.</p>
<p><b>OFF</b></p> <p><b>LONG CABLE</b></p>	
<p><b>Sync To</b></p>	<p>(Generator synchronized to)</p> <p>indicates what the digital audio generator is synchronized to. Depending on the "Src Mode", certain selections cannot be made.</p> <p>Synchronization to the audio input signal; <i>not possible with JITTER ONLY or PHASE.</i></p> <p>Synchronization to the REF IN input signal (XLR socket on the rear panel); <i>not possible with PHASE.</i></p> <p>Synchronization to the SYNC IN input signal (BNC connector on the rear panel) <i>not possible with JITTER ONLY or PHASE.</i></p> <p>Synchronization to the internal clock generator</p>
<p><b>AUDIO IN</b></p> <p><b>REF IN</b></p> <p><b>SYNC IN</b></p> <p><b>GEN CLK</b></p>	
<p><b>Sync Mode</b></p>	<p>is displayed only if the generator is synchronized to the SYNC IN input (rear); indicates the synchronization mode used.</p> <p>Sample frequency synchronized to a video frequency of 50 Hz. (Europe).</p> <p>Sample frequency synchronized to a video frequency of 60 Hz (USA).</p> <p><b>Note:</b> with VIDEO 50 and VIDEO 60, an appropriate composite video signal must be applied to the SYNC input</p> <p><b>UPL-B29:</b> VIDEO 60 can only be operated with fixed frequencies of at least 48 kHz.</p> <p>Sample frequency synchronized to a 1024-kHz reference signal.</p> <p>Sample frequency synchronized to the word-clock signal at the SYNC input.</p> <p>Sample frequency synchronized to the inverted word-clock signal at the SYNC input.</p>
<p><b>VIDEO 50</b></p> <p><b>VIDEO 60</b></p> <p><b>1024 kHz</b></p> <p><b>WORD CLK</b></p> <p><b>WRD CLK INV</b></p>	

Sample Frq	Setting the output clock rate.
<p>32 kHz 44.1 kHz 48 kHz 88.2 kHz 96 kHz</p>	<p>Depending on the selected synchronization in the generator-menu line "Sync To" the following information on the clock rates can be given:</p>
	<p>with option UPL-B2 (digital audio I/O) only</p>
<p>VALUE</p>	<p>with option UPL-B29 (digital audio 96 kHz) in the high rate mode only with option UPL-B29 (digital audio 96 kHz) in the high rate mode only</p>
<p>EXTERN</p>	<p><b>UPL-B29:</b> For selecting the fixed frequencies 88.2 kHz and 96 kHz, the menu line "Sample Mode" in the OPTIONS panel must be set to HIGH RATE. The fixed frequency 32 kHz is no longer supported. The fixed frequency 44.1 kHz cannot be selected if the "Sync Mode" is set to VIDEO 60.</p>
	<p>The fixed frequencies can be selected when the generator is internally clocked or synchronized via the SYNC IN female connector. This is specified in the menu line "Sync To" GEN CLK or SYNC IN</p>
	<p>The generator must be clocked internally in order to enable a user-definable value to be entered under "VALUE": "Sync To" GEN CLK</p>
	<p>An external clock can be entered as a numeric value when the generator is synchronized to a word-clock signal (inverted, if required) via the SYNC IN or via the REF IN female connector:</p>
	<p>"Sync To" SYNC IN "Sync Mode" WORD CLK or WORD CLK INV</p>
	<p><b>Important:</b> If the frequency entered does not correspond to the frequency applied, the frequencies of the generated signals vary correspondingly! The applied sample frequency must be in the range between <b>27 kHz and 55 kHz</b> (option UPL-B2) or <b>40 kHz and 106 kHz</b> (option UPL-B29. If these limits are exceeded the synchronization may be lost and the processor of the generator may be overloaded</p>
	<p><b>Status display:</b> GEN: ORUN;</p>
	<p><b>Remedy:</b> Reduce the external clock rate and restart the generator by acknowledging the generator instrument.</p>
<p>SYNC TO ANL</p>	<p>If the generator is synchronized to the input signal of the analyzer, this selection item is displayed; it cannot be modified. The synchronization to the analyzer is defined in menu line "Sync To" AUDIO IN</p>
	<p>The numeric value of the sample frequency is copied from the analyzer panel and cannot be modified in the generator panel.</p>
	<p><b>Note</b> The selected sample frequency can be copied automatically into the Channel -Status Bits. The Channel status file or the "Panelfile" used here has to contain appropriate keywords</p>

(see 2.5.3.2 AES/EBU protocol definition ). The example files with the extensions \*PGC and \*PPC are already configurated. Using the panel file the user can choose in the protocol menu of the generator panel whether the automatism should be applied ("Rate GEN SMPLFRQ") or whether a fixed sample rate should be entered into the Channel Status Bits.

<b>Sync Out</b>	specifies the clock signal applied to the SYNC OUT output (BNC female connector on the rear of the instrument).
<b>AUDIO IN</b>	Digital AUDIO input signal (front panel)
<b>REF IN</b>	REF IN input signal (XLR female connector on the rear panel);
<b>SYNC PLL</b>	signal from the internal synchronization PLL (e.g., input signal with eliminated jitter)
<b>GEN CLK</b>	internal generator clock
<b>Type</b>	indicates the type of SYNC OUT signal
<b>WORD CLK</b>	word-clock signal (sample frequency)
<b>BIPHASE CLK</b>	biphase clock signal (128 times the sample frequency)
<b>Ref Out</b>	specifies the signal applied to the REF OUT output (XLR female connector on the rear).
<b>AUDIO IN</b>	(buffered) audio input signal;
<b>AUD IN RCLK</b>	audio input signal reclocked by the internal synchronization PLL
<b>AUDIO OUT</b>	generated audio signal (same as on the front panel)
<b>REF GEN</b>	generated reference signal, which can be defined constant low (ALL ZERO) or constant high (ALL ONE) in the next menu line "Data".
<b>Data</b>	is displayed only, if REF GEN has been selected for REF OUT signal.
<b>ALL ZERO</b>	Defines the audio data which are output at the REF OUT output (XLR female on the rear panel). all data bits are reset (low level)
<b>ALL ONE</b>	all data bits are set (high level)

**Audio Bits**

Displayed only when Src Mode AUDIO DATA is selected. Word width of generated audio samples in bits.

Value range: 8 to 24

If the word width is reduced, the values of the audio samples are rounded to the specified word width.

**Unbal Vpp**

Sets the output voltage of the digital signal at the UNBAL (BNC) interface. Peak-to-peak voltage upon termination with nominal impedance ( $75 \Omega$ ); without termination the voltage is twice as high.

Setting range: 0 mV to 2.125 V; resolution 8.33 mV

This voltage is always  $\frac{1}{4}$  of the voltage at the BAL (XLR) interface.

**Bal Vpp**

Sets the output voltage of the digital signal at the BAL (XLR) interface. Peak-to-peak voltage upon termination with nominal impedance ( $110 \Omega$ ); without termination the voltage is twice as high.

Setting range: 0 mV to 8.5 V

This voltage is always 4 times as high as the voltage at the UNBAL (BNC) interface.

**Max Volt**

Displayed only if Src Mode AUDIO DATA or phase has been selected. Limit value for entry of the output; prevents inadvertent entry of impermissibly high voltage values .

**Ref Freq**

Reference value for the relative frequency units.

A change of the reference frequency causes all reference-related frequency inputs to change.

The relative frequency of the generator signal is retained.

By varying the reference frequency, the fundamental of a distortion spectrum set by means of multisine can for example be shifted without the harmonics having to be recalculated and set again by the user.

**Note:** *If a generator frequency sweep is active (X-Axis FREQ) and AUTO scaling is selected for the X axis in the DISPLAY panel, the reference value is used in the DISPLAY panel as the X-axis reference when a (new) value is entered.*

## Ref Volt

Reference value for the relative voltage units.

A change of the reference level causes all reference-related voltage inputs to change. The relative voltage of the generator is retained.

By varying the reference voltage, a level sweep defined with relative start and stop levels can for example be shifted by a constant gain factor.

Units (depending on source mode):

AUDIO DATA/PHASE: FS | %FS | dBFS | Δ% | LSBs | dBr | bits

JITTER ONLY : UI | %UI | dBUI | ppm | ns | UIr | dBr

COMMON ONLY: V | mV | μV | dBV | dBu

**Note:** *If the reference value is entered with a reference-related unit (e.g. dBr), the entered value is converted to the basic unit in relation to the previous reference value and then stored. This new reference value is displayed in relation to the **new** reference value (e.g. 0 dBr). Thus any reference value can be varied by a desired factor or dB value.*

**Example:**  $0.174 \text{ FS} - 10 \text{ dBr} = 0.055 \text{ FS}$

**Note:** *If a generator frequency sweep is active (X-Axis FREQ) and AUTO scaling is selected for the X axis in the DISPLAY panel, the reference value is used in the DISPLAY panel as the X-axis reference when a (new) value is entered.*

### 2.5.3.1 Generating Jitter, Phase and Common Mode

With digital audio interfaces, there are two types of signals to be measured, e.g. within a quality check. One is the digitally coded analog signal, and the other the digital signal. The latter too has analog parameters such as peak-to-peak voltage, frequency etc. It may be subject to interference like an analog signal. Noise or AC voltage may be superimposed, which may cause the signal slopes to be shifted. This effect is called jitter and, if it is strong enough, the audio signal can no longer be decoded or regenerated correctly. An exactly defined interference signal is to be generated by the UPL generator to examine the compatibility to jitter.

The signal lines can be designed as balanced lines which is quite usual in analog technology. Thus, injected interference, e.g. from grounded (hum) loops, would be ineffective. However, in practice this attenuation is not always sufficient so that a common-mode voltage of sufficiently high magnitude may prevent decoding and regeneration. The UPL can generate a common-mode voltage on the digital signal in order to test instruments. Of course, a common-mode signal cannot be generated at the unbalanced and the optical output.

The UPL can thus generate and simulate two different interferences of the digital audio signals: specific shifting of the signal slopes (JITTER ONLY) and the superimposition of the digital lines (COMMON ONLY) by a common-mode voltage. The sine and noise functions (arbitrary and random) are particularly suited for practical applications.

For many applications, it would be useful to determine the audio content of the signal in addition to the jitter or common-mode signal, i.e. to generate an audio signal impaired by jitter or a common-mode voltage. Thus the influence of the disturbing signal on the audio signal can be measured with option UPL-B1 fitted. UPL offers an operating mode for this case too. An additional sinewave generator (AUX GEN) can be switched on in the source modes AUDIO DATA and PHASE where any digital audio signal can be generated to superimpose either a jitter or a common-mode signal on the audio signal.

Jitter and delay are usually stated in UI (unit interval). UI is defined as the smallest pulse width of the digital audio signal (eye width) and is independent of the selected sampling rate. One UI corresponds to the clock period of the digital signal (biphase clock). With digital audio signals, one UI corresponds to 128th of the sampling period; at 48 kHz one UI is approx. 163 ns.

If several, digitally-coded signals have to be combined, as is commonly done in the studio, the signal synchronization is also of importance. Associated frames containing the instantaneous values (samples) of the left and right channels must not be delayed to such an extent that the timing tolerances of the receiver are exceeded. The UPL can simulate this error by rendering the phase between the digital output on the front panel and the independent reference generator with output on the rear panel adjustable. This refers to the phase within a frame (or 64 bits or 128 UI).

Even if the clock frequency is precisely generated by the various instruments, the frequencies tend to drift with respect to one another, which can be noticed as a phase offset (see above). This drift causes omission or doubling of individual samples. This effect can be avoided by distributing a frame sync or word clock to all instruments for synchronization, or by synchronizing them to a common clock frequency (e.g. 1024 kHz or the video sync pulses). Hence, if the UPL is to behave like an ideal source of digital signals, it must be integrated into this synchronization concept. It can, therefore, be synchronized via the SYNC IN female on the rear panel to the signals selected by means of the Sync Mode command.

In addition to the method described above, the generator can also be synchronized to the digital signal at the analyzer input using a clock frequency. A differentiation has to be made between the input on the front panel and the input of the reference receiver on the rear panel. Moreover, the generator can be operated with an own crystal oscillator.

The mode set (phase, jitter or common mode), i.e. the superimposed interference voltage always refers to the digital output on the front panel. The reference generator whose output is on the rear panel is always used as reference. If the generator is operated with external synchronization, ('Sync To' does not select GEN CLK), the reference corresponds to the synchronization. Besides, the synchronization output ('Sync Out' on the rear panel) is always without jitter or phase shift.

### 2.5.3.2 AES/EBU Protocol Definition

Selection of the digital generator causes the additional section PROTOCOL to be displayed in the GENERATOR panel. This section sums up the commands for definition of the protocol information (channel status data, user data, validity, parity).

<b>PROTOCOL</b>	Determines the scope of the protocol information generated.
<b>PANEL OFF</b>	<p>No possibility to enter channel status data. The state last defined is stored statically in the setup and restored again when the UPL is switched on or during setup loading. Same internal behaviour as STATIC.</p> <p>If the generated channel status data is irrelevant, the menu lines not wanted can be deleted from the generator panel.</p>
<b>STATIC</b>	<p>Only static channel status data - identical for both channels - can be generated with or without a valid CRC. This operating mode is always possible without any restrictions. The range of functions depends on whether or not the UPL-B21 option (Digital Audio Protocol) is installed.</p> <p>If the UPL-B21 is not installed, the bits can only be reset or defined via a file. If the UPL-B21 option is installed, the audio bits can additionally be entered in binary form or via a static protocol panel.</p>
<b>ENHANCED</b>	<p>Only selectable if the UPL-B21 option (Digital Audio Protocol) is installed. The full scope of protocol data generation can be entered and is displayed in the generator panel.</p> <p>Besides the valid CRC, the local time code can also be generated which is reset and a count started when the generator starts up.</p> <p>In this mode, also the analyzer has to be set to protocol analysis. Therefore, the following settings are automatically executed in the analyzer panel when ENHANCED is switched on:</p> <ul style="list-style-type: none"> <li>• INSTRUMENT       DIGITAL</li> <li>• Anlr Mode         AUDIO DATA</li> <li>• FUNCTION         PROTOCOL</li> </ul> <p>As soon as one of the 3 analyzer menu lines mentioned is changed, the ENHANCED mode is switched to PANEL OFF.</p>

<b>Validity</b>	Set the validity identification within the AES/EBU data stream.
<b>NONE</b>	No validity bit set
<b>1&amp;2</b>	Validity bit set in both channels

Ch Stat. L	
ZERO	defines the way in which channel status data LINKS are generated. This includes the operating mode (AES3, CRC or RAW), which has to be identical for the left and right. If left is selected for raw data generation, ie if neither AES3 nor CRC are defined, the operating mode can be freely selected via the menu line Ch Stat. R.
FILE + AES3	All channel status data bits are 0. (The operating mode (AES3, CRC, RAW) is defined with the command Ch Stat. R).
PANEL + AES3	UPL generates local timecode and CRC, other channel status data are defined using the following file.
FILE + CRC PANEL + CRC	UPL generates local timecode and CRC, other channel data are set using the panel defined by the "Panelfile" file.
FILE	As FILE + AES3 or PANEL + AES3, however UPL does not generate local timecode, which is a fixed setting instead.
PANEL	As FILE + AES3 or PANEL + AES3, however UPL generates neither local timecode nor CRC (RAW mode).  The setting that can be made under this menu item affects Ch Stat. R. Any settings under Ch Stat. R. that are incompatible with the selection made here causes a corresponding error message to be output and the setting to be rejected.  The following restrictions apply: <ul style="list-style-type: none"> <li>• PANEL (= user-definable generator commands) can only be used with Ch Stat L or Ch Stat R.</li> <li>• The operating mode must be the same for both channels.</li> </ul>
BINARY...	If this parameter is selected, a menu is displayed which allows for binary entry of the individual channel-status bits. The data are copied in by actuating the OK field. BIN ENTRY can be used once with CH Stat L or Ch Stat R, only. The SELECT key (or space bar on the external keyboard) causes the respective bit to change from 0 to 1 or vice versa.

**Note:** *Local Time Code is a counter defined in accordance with AES3 which indicates the time elapsed since the beginning of transmission in samples. This counter is incremented by the UPL in the PANEL+AES and/or FILE+AES modes by 192 per frame. The value indicated in the file or panel is used as start value.*



Filename
----------

Specifies a file containing the channel status data for LEFT.

Preset file type: \*.pgc

Data are defined in single lines. Keywords in the file specify for which bits and side (left, right or both) the data are intended.

With this command only the definitions containing information data for the left or for both sides are considered. Thus the same file can be used for both sides.

Syntax:

Side: AES\_CHAN\_STAT or AES\_CHAN\_STAT\_BOTH indicate the beginning of data for both sides. Analogously, AES\_CHAN\_STAT\_RIGHT and AES\_CHAN\_STAT\_LEFT indicate the beginning of data for one side.

These keywords may be used in any order and as often as desired.

Data: Values in the file are entered with the following line:

Keyword BIT followed by a destination range and the respective value.

**Example:** BIT:12-15, 1  
(bits 12-15 are assigned 0001)

The **time** of the UPL can be specified using the keyword TIME instead of a value. To obtain the number of samples made since midnight, the time is multiplied by the currently selected sample rate (see section 2.5.3).

**Example:** BIT:112-143, TIME

The **sample rate** selected in the configuration section of the UPL generator (see section 0) can be entered automatically into the specified bit position using keyword RATE\_TRK. UPL recognizes by means of the bit position whether the sample rate has to be coded in the consumer or the professional format and enters the respective values accordingly.

**Example:**

BIT:6-7, RATE\_TRK (professional format)  
BIT:35-38, RATE\_TRK (enhanced rate for professional format)  
BIT:24-27, RATE\_TRK (consumer format)

Example file: R&S\_AES3.PGC (Professional format)

**Notes:** *The local time (bit #112 to #143) is set to 0 when the generator is started and upcounted with the sample rate, i.e. it indicates the number of samples made since the generator start. In protocol analysis the time elapsed since the start of the generator can be determined by considering the sample rate.*

*The absolute time (bit #144 to #175) with the number of samples made since midnight is loaded when the generator is started and remains unchanged. In protocol analysis the time of the generator start can be determined by considering the sample rate.*

*Thus the actual time can be determined at any time by adding Local and Time.*

Ch Stat. R	
	Specify how to generate the Channel Status data RIGHT.  The setting that can be made here is a function of Ch. Stat. L. The PANEL can be assigned only once. The operating mode (AES3, CRC, RAW) must be the same for both channels. For more details on the individual commands, refer to Ch. Stat L.
ZERO	All channel status data bits are 0. (Operating Mode (AES3, CRC, RAW) is defined by Ch. Stat L. When Left is also set to ZERO, the operating mode is RAW).
EQUAL L	Both sides are the same. All definitions made for the left side are copied to the right. The operating mode is defined by Ch. Stat L.
FILE+AES3	This selection is displayed only when ZERO, FILE+AES3 or PANEL+AES3 have been selected for Ch. Stat L.
PANEL+AES 3	This selection is displayed only when ZERO, FILE+AES3 have been selected for Ch. Stat L.
FILE+CRC	This selection is displayed only when ZERO, FILE+CRC or PANEL+CRC have been selected for Ch. Stat L.
PANEL+CRC	This selection is displayed only when ZERO or FILE+CRC have been selected for Ch. Stat L.
FILE	This selection is displayed only when ZERO, PANEL or FILE have been selected for Ch. Stat L.
PANEL	This selection is displayed only when ZERO or FILE have been selected for Ch. Stat L.
BIN ENTRY	This selection is displayed only, if BIN ENTRY has not yet been selected with Ch. Stat L.

Filename	
	Specify a file containing Channel Status data for RIGHT.  preset type of file: *.pgc  The data are each defined in a line. Keywords in the file specify for which bits and side (left, right or both) the data are defined (see also specifications for the left side). When using this command, only those definitions containing data for the right or for both sides are considered. This allows you to use the same file for both sides.  Format:           see Ch. Stat. L

<b>User Mode</b>	Specify how to generate the user data.
<b>ZERO</b>  <b>FILE DEF</b>	All user bits are initialized to be 0.  User bits are output according to the definitions in the subsequent file.
<b>Filename</b>	<p><b>Note:</b> <i>Changing the user bits stops both the generator and the analyzer for a short time.</i></p> <p>Specify a file containing user data. Preset type of file: *.pgu</p> <p>The file contains both user data for the left and the right side. The keyword AES-USER-DATA-LEFT is used to indicate the beginning of data for the left side. Analogously, AES-USER-DATA-RIGHT is used for the right side.</p> <p>In the following lines, values must be entered as hexadecimal numbers without any further designations . Each line contains 32 bits. The UPL repeats block-synchronously user bits read in, the length of each cycle being equal for both sides. 192 user bits can be read in on each side. Reading in less bits on one side than on the other causes zeros to be inserted. 6 (or a multiple thereof) result in correlated user data from the beginning of the block. The maximum permissible number of user bits is 4096 words = 16384 bytes = 131072 bits per side. Example: AES_USER_DATA_RIGHT           0x55504E20                   # = 'UPL '</p>

<b>Panelfile</b>
------------------

Specify a file which contains the definitions of the freely programmable panel. This menu item is displayed only when a panel has been specified for Ch. Stat L or Ch. Stat R.

Preset type of file: \*.PPC

This file allows you to define an input field tailored to meet the current requirements. This file, thus, defines the screen display for entry of the actual values. To this end, enter the respective command designations, the permissible range of values and the destination of the setting into the file. Sample files for the "professional" and "consumer" format according to IEC 958 are contained in the "C:\UPL\USER" file supplied with the instrument (R&S\_AES3.PPC and R&S\_CONS.PPC). 4 types of commands are permissible:

- **Selection commands**

Entering the keyword SELECTION or EXTSELECT followed by parameters defines a selection command.

When the keyword RATE\_TRK is entered with parameters specifying the sample rate, a special selection command is defined which causes item GEN SMPLFRQ to be additionally displayed in the panel. RATE\_TRK may only be used where the bits for the sample rate are defined (in the consumer or professional format); otherwise this keyword has the same effect as SELECTION.

**xamples:**

⇒ SELECTION " Use", BIT:0, 0="CONS", 1="PROF"

(Bit 0 of the channel status data can be switched between CONS and PROF using the menu line 'Use'.)

⇒ SELECTION " Usermod", BIT:12-15, 0="not ind", 3="USER"

(The four bits 12 to 15 can be switched between not ind and USER using the menu line 'Usermod'.)

⇒ RATE\_TRK " Rate", BIT:6-7,

0="not ind", 1="44.1 kHz", 2="48 kHz", 3="32 kHz "

- Bits 6 and 7 of the channel status data can be switched between "ANLR TRACK", "not ind", "44.1 kHz", "48 kHz", "32 kHz" and "GEN SMPLFRQ" using the menu line "Rate". By selecting GEN SMPLFRQ the sample rate selected in the generator configuration section is automatically transferred to the channel status data. Frequencies above 48 kHz (with option UPL-B29) are shown as "not indicated", according to standard AES3.
- RATE\_TRK " enh.Rate", BIT:35-38,  
0="not ind", 1="24 kHz", 2="96 kHz", 3="192 kHz",  
9="22.05 kHz", 10="88.2 kHz", 11="176.4 kHz", 15="User def"  
Bits 35 to 38 of the channel status data can be switched between the encoded sampling points and (in addition) GEN SMPLFRQ by means of the menu line "enh. Rate". By selecting GEN SMPLFRQ, the sampling rate selected in the configuration section of the generator is automatically adopted for the channel status data. Frequencies below 88.2 kHz are encoded as "not indicated".

**otes:**

⇒ The channel status data are encoded according the AES3 recommendation of 1 November 98. Max. 12 normal selection commands and 3 extended ones are permissible.

- ⇒ The BIT interval must not be larger than 32.
- ⇒ Max. 8 selections per command (SELECTION) are permissible. Any value within the specified range of bits can be assigned to the selections.
- ⇒ In the case of overlapping bit ranges, the most recent setting overwrites the bits defined before.

Up to 24 selection possibilities are permissible with EXTSELECT.

- **Text commands**

Entering the keyword TEXT followed by parameters defines a text command.

**Example:**

- ⇒ TEXT " Origin", BIT:48-79  
(The 32 bits 48 to 79 of the channel status data are filled with the text characters to be entered here.)

**Note:**

- ⇒ Up to 4 selection commands are permissible.
- ⇒ The BIT interval must not be larger than 32, i.e. max. 4 text characters (ASCII) per command are permissible.

- **Value commands (normal)**

Entering the keyword VALUE followed by parameters defines a value command, which allows the specification of status bits as numbers. These numbers can even be multiplied by a multiplier specified in the file.

**Example:**

- ⇒ VALUE " Abs.Hour", BIT:144-175, MULT:SET-RATE
- ⇒ MULT:3600 (The value defined here is entered into the 32 bits 144 to 175, the number after MULT (3600 \* and SET-RATE = set sample rate) being multiplied by the value before it is entered.)

**Note:**

- ⇒ Max. 12 value commands are permissible.
- ⇒ The BIT interval must not be larger than 32, the entry is limited to 31 bits.
- ⇒ The two keywords MULT are optional. The keyword SET-RATE can also be used as multiplier.

- **Value commands (additive)**

The entry of the keyword ADDVALUE followed by parameters defines a value command, the value being added to already available values.

**Example:**

- ⇒ ADDVALUE " Abs.Min", BIT:144-175, MULT:2880000
- ⇒ (The value entered here is added to the 32 bits 144 to 175 of the channel status data. Prior to the addition, the number after MULT (2880000 = 60 \* 48000) is multiplied by the value.)

**Note:** See under value command (normal).

**Examples:**

- R&S-AES3.PPC for panel acc. to AES3 format
- R&S-CONS.PPC for panel acc. to consumer format

In the panel, the UPL displays the commands in the order

1. SELECTION/EXTSELECT/RATE\_TRK
2. VALUE / ADD VALUE
3. TEXT

In the file, any desired order is permissible.

## 2.5.4 Functions

FUNCTION	
<b>SINE</b>	Single sine, dither may be included.
<b>MULTISINE</b>	Up to 17 sines
<b>SINE BURST</b>	Sine burst signal
<b>SINE<sup>2</sup> BURST</b>	Asymmetrical sine burst
<b>MOD DIST</b>	Test signal for intermodulation distortions
<b>DFD</b>	Test signal for difference frequency distortions
<b>RANDOM</b>	Random noise
<b>ARBITRARY</b>	Arbitrary waveform and WAV file output
<b>POLARITY</b>	Test signal for polarity measurements
<b>FSK</b>	Frequency shift keying; only if the UPL-B33 option is installed; only required for ITU-T O.33 (line measurement). Not available in the digital generator of the UPL16.
<b>STEREO SINE</b>	Stereo sine, digital only, only if the UPL-B6 option is installed. Not available in the digital generator of the UPL16.
<b>MODULATION</b>	Frequency or amplitude modulation (sine signal).
<b>DC</b>	DC signal.
<b>CODED AUDIO</b>	Digitally coded audio data to IEC 61937. Only digital if the UPL-B23 option is installed.

**Note:**

*When the function is changed, the generator is briefly stopped. The output signal is then set to 0 V or 0 FS.*

2.5.4.1 Common Parameters for Generator Signals

2.5.4.1.1 Common Parameters for SINE, DFD, MOD DIST Signals

<p><b>Frq Offset</b></p>	<p>Frequency offsets when entering frequencies.</p>
<p><b>+1000 ppm</b></p>	<p>Set the frequency with an offset of +0.1%</p> <p><i>Note: If the generator frequency is referenced to per GENTRACK with frequency offset switched on, the <b>set</b> frequency and not the actually generated one is used as reference (see 2.6.5.1, RefGen)</i></p>
<p><b>OFF</b></p>	<p>Set the frequency without offset</p>
<p><b>Dither</b></p>	<p>For the digital generator, only (DIG 48 kHz) option UPL-B2 or UPL-B29, only</p>
<p><b>ON</b></p>	<p>A noise component is superimposed on the signals. The amplitude of the noise component can be entered in the next menu line. The power density function (PDF) can be entered further down. It is recommended to use only low noise amplitudes, eg the final 1 to 3 LSB.</p> <p><i>UPL-B29: In the high rate mode, dither can only be generated for the sinewave signal, whereas the base rate mode also enables multitone signals.</i></p>
<p><b>OFF</b></p>	<p>No superimposed noise</p>
<p><b>PDF</b></p>	<p>Only for the digital generator (DIG 48 kHz), with activated dither Select the amplitude distribution (probability distribution function) of the superimposed noise signal.</p>
<p><b>GAUSS</b></p>	<p>Gaussian distribution</p>
<p><b>TRIANGLE</b></p>	<p>Triangular distribution from -peak to +peak</p>
<p><b>RECTANGLE</b></p>	<p>Equivalent distribution from -peak to +peak</p>

### 2.5.4.1.2 Common Parameters for All Generator Functions

DC Offset

ON

OFF

permits the superposition of a settable direct voltage on the generator output

The signals are superimposed a DC voltage content. The amplitude of the DC voltage content can be entered in the next menu line. This selection is permitted for all functions of the function generator, except for the (analog) low-distortion generator.

no DC voltage signal active

**Note:** for the analog generators, offset is limited on  $\pm 5$  V (UNBAL) or  $\pm 10$  V (BAL)



2.5.4.1.3 Equalization of the Signals SINE, SINE BURST, DFD, MULTISINE, RANDOM

<b>Equalizer</b>
ON
OFF

Activate/Deactivate an equalizer table including frequency specifications and appertaining voltage amplification factors. Depending on the frequency, the set voltage can be multiplied by an equalizing factor (after interpolation between the adjacent frequency points) before they are switched to the outputs. The equalized voltage can be measured internally by means of the analyzer.

**Note:** When entering equalizing factors > 1 it may occur that the equalized voltage exceeds the selected maximum voltage (entry under menu item Max Volt) or the physically feasible voltage. If this is the case, the voltage output is limited (to the smaller of the two values).

**Typical application:**  
 Simulating the effects of a preemphasis; measurement with constant power on DUTs with frequency response.

Equalizer is switched on. Menu item "Equal. file" is activated, i.e. the file listed under this menu item is loaded.

**Note:** If the generator voltage is referenced to per GENTRACK with the equalizer switched on, the **set** voltage and not the equalized one is used as reference (cf. 2.6.5.1 Reference).

Output voltage is not affected.

<b>Equal. file</b>
--------------------

(Equalizer file)  
 with Equalizer → ON only;  
 Menu item for entry of the equalizer file name. The file is opened and saved in an internal buffer.

Entering an invalid name (disk drive not ready, file not found, invalid format, etc.) leads to the output of an error message and the entry "not found" in the menu line.

For entering a file name, see 2.3.2.5;  
 For generation of an equalizer file, see 2.9.1.2 Loading and Storing of Series of Measured Values and Block/List Data ("Store → EQUALIZATN").

#### 2.5.4.1.4 Amplitude Variation of the Signals MULTISINE, RANDOM and ARBITRARY

##### Ampl Var

OFF

SINE

BURST

Selection of type of modulation. In contrast to the classic modulation as it is offered (for sine signals) by the MODULATION function, 2 different methods of amplitude modulation are offered here. Besides, the signal is not modulated with the set level, which is approximated by +/- 100% maximum, but varied by 0 ... -100%. For distinction from modulation, this procedure is referred to as "amplitude variation" and "variation" instead of "amplitude modulation" and "modulation depth".

The amplitude variation is switched off, the generator signal is not modulated.

The generator signal is amplitude-modulated from 0% - 100% in the form of a sinewave.

The generator signal is switched on and off periodically.

##### Mod Freq

with "Ampl Var SINE", only: setting of the modulation frequency

Range of values:  $1\mu\text{Hz}$  to  $f_{\text{max}}$   
 $f$  depending on the generator;  
 see 2.5.1 Selecting the Generator

##### Variation

with "Ampl Var SINE", only: setting of the variation in %, which the signal is reduced by, ie., is varied.

Range of values: -100 to 0 %

**Example:** Output levels of 9.90 V to 10.0 V are obtained with a carrier amplitude of 10 V and a variation of -1 %.

## ON TIME

with "Ampl Var BURST", only: entry of the burst duration, i.e., the time while the sine is switched on.

Specified range: lower limit : (1 sample)

analog:  $t_{\min} = 20.83 \mu\text{s}$

digital:  $t_{\min} = 1 / \text{sample frequency}$

upper limit: 60 s –  $t_{\min}$

Units: s | ms |  $\mu\text{s}$  | min

**Side effect:**

*If a burst duration is entered which exceeds the interval length, the latter is increased to burst duration +  $t_{\min}$ .*

**Remark on the unit:**

*In contrast to the SINE BURST function, the burst duration cannot be entered in cycles, since the signal is not a single sine.*

## INTERVAL

with "Ampl Var BURST", only: entry of the burst interval length (burst period), i.e., the sum of burst duration and break time.

Specified range: lower limit: set burst duration.

upper limit: 60 s

Units: s | ms |  $\mu\text{s}$  | min

**Remark on the unit:**

*In contrast to the SINE BURST function, the burst period cannot be entered in cycles, since the signal is not a single sine.*

### 2.5.4.2 Sweeps

With many generator functions, it is useful to output signal parameters (level, frequency, in the case of burst signals also switch-on time and length of intervals) not only statically but to vary them with respect to time. A sweep system allowing 2 parameters to be varied simultaneously (two-dimensional sweep) is available for these signals.

- One-dimensional sweep: the parameter specified under X-axis is varied from start to stop or according to the LIST file.
- Two-dimensional sweep: the parameter specified under Z-axis is set to the start value or the first entry in the 1st LIST file. The parameter defined under X-axis is varied from start to stop or in accordance with the 2nd LIST file. The Z-parameter is then set to the next value and the sweep of the X-parameter starts again from the beginning. The two-dimensional sweep is concluded when the Z-parameter has assumed its final value. When a Z sweep is switched on, Scan count is set according to the number of Z points.

The so-called "LIST buffers", with a length of 1024 entries each, serve as data source for the sweep parameters. The total length of the LIST buffers is obtained by multiplying the lengths of X- and Z-buffer; with one-dimensional sweeps, the length of the Z-buffer is to be defined as 1. If you specify too many items, the last ones, i.e. those exceeding 1024 are ignored. Each buffer contains a table, which can either be derived from user specifications (normal sweep) or is loaded from a file (list sweep; see Sweep→Ctrl).

With normal sweeps, tables with equidistant rising or falling values are generated depending on whether the start value is lower or higher than the stop value. As soon as a "normal" sweep is switched on or a new start value is selected, the start value is set in the instrument hardware, in order to keep the settling time with starting of sweep as short as possible.

With "list-controlled sweeps", the values for the sweep parameters can be spaced as desired, however, they must be consecutive (just as with "normal" sweep) ( 2.9.3 Series of Measured Values (Sweeps and Scans) and Block/List Data).

If a running sweep is stopped or switched off, the swept parameters retain the current numeric values.

**Note:** *Sweeping from high to low frequencies allows the beginning of the sweep curve to be displayed faster than its end because high frequencies require less measuring time.*

For starting and stopping the sweep, see 2.11.

Table 2-26 List of sweepable function parameters depending on the function selected:

Function	VOLTAGE	FREQUENCY	ON-TIME	INTERVAL
SINE	yes	yes	---	---
MULTISINE	no	no	---	---
SINE BURST	yes	yes	yes	yes
SINE <sup>2</sup> BURST	yes	yes	yes	yes
MOD DIST	yes (total Volt)	yes (user frequency)	---	---
DFD	yes (total Volt)	yes (mean frequency)	---	---
RANDOM	no	---	---	---
RANDOM+ANLR	no	---	---	---
ARBITRARY	no	---	---	---
FSK	no	no	---	---
POLARITY	no	---	---	---

**Remark:**

In addition to the above generator sweeps, several analyzer sweeps can be performed:

- time-controlled analyzer sweeps are selected under menu item START COND in the ANALYZER panel (for all measurement functions)
- external frequency or level sweeps are also selected in the ANALYZER panel under menu item START COND (for all measurement functions)
- the bandpass mean frequency can be swept in the RMS SELECTIV measurement.

Only one generator or one analyzer sweep can be active at a time. If a 2nd sweep is selected, the first sweep is switched off again and a warning is read out.

SWEEP Ctrl	Activate/Deactivate the sweep system and specify the data source and sweep run.
<b>OFF</b>	The sweep system is switched off; all parameters are entered directly into the panel by the user.
<b>AUTO SWEEP</b>	<p>The sweep runs automatically after having pressed the START or SINGLE key (see 2.11 Starting and Stopping of Measurements or Sweeps).</p> <p>The data of the sweep parameters are obtained from user specifications (start/stop value and step size or number of points); normal sweep</p> <p>Sweep stepping can be synchronized with the analyzer in menu item Next Step.</p>
<b>AUTO LIST</b>	<p>The sweep runs automatically after having pressed the START or SINGLE key (see 2.11 Starting and Stopping of Measurements or Sweeps).</p> <p>The data of the sweep parameters are read from file; (list sweep) for generation of lists, see 2.9.1.2, menu item STORE TRACE/LIST, Store → X AXIS, Store → Z AXIS</p> <p>Sweep stepping can be synchronized with the analyzer in menu item Next Step.</p>
<b>MANU SWEEP</b>	<p>The sweep is controlled by means of the rotary knob and/or the cursor keys. When you press the START key, the 1st measured value only is recorded. Any further sweep point must be explicitly requested using the rotary knob or by pressing a cursor key (see 2.11 Starting and Stopping of Measurements or Sweeps).</p> <p>The data of the sweep parameters are obtained from user specifications (start/stop values and step size or number of points); normal sweep.</p> <p>When sequencing the manual sweep, the result of the current measurement is not waited for, i.e. the current measurement and possibly a set analyzer delay are aborted.</p>
<b>MANU LIST</b>	<p>The sweep is controlled by means of the rotary knob and/or the cursor keys. When you press the START key, the 1st measured value only is recorded. Any further sweep point must be explicitly requested using the rotary knob or by pressing a cursor key (see 2.11 Starting and Stopping of Measurements or Sweeps).</p> <p>The data of the sweep parameters are read from a file; list sweep.</p> <p>For generation of lists, refer to 2.9.1.2, menu item STORE TRACE/LIST, Store → X AXIS, Store → Z AXIS</p> <p>When sequencing the manual list sweep, the result of the current measurement is not waited for, i.e. the current measurement and possibly a set analyzer delay are aborted.</p>

**Notes on manual sweep:**

- In order to control manual sweeps using the rotary knob or the cursor keys, the graphics must be active (full-screen or part-screen mode). When the sweep is started, the switchover to the graphics panel occurs automatically.
- The feature "manual sweep" can be used to vary generator parameters with a user-definable increment. The increment is defined by a fixed "step" (with MANU SWEEP) or by a variable step size defined per file (with MANU LIST). In remote control mode, the command "INIT:NEXT<n>" is used to continue.

- Individual sweep points can be skipped by turning the rotary knob fast. Also, sweep points can be repeated by turning the rotary knob back.
- The measured values are represented by means of crosses in the Curve Plot mode. With the DISPLAY panel setting Scan count >1 selected, these crosses are not deleted before being updated but remain on the screen. With strongly fluctuating measurement values, the representation approximates the shape of a bar. If sweep steps are skipped or advanced too fast, a NAN (Not A Number) value is entered. When reaching the end of sweep, the complete trace (with the latest measured values) is obtained.

**Next step**

- ANLR SYNC**
- DWELL VALUE**
- DWELL FILE**

With automatic sweep stepping ("Sweep Ctrl → AUTO SWEEP" or "Sweep Ctrl → AUTO LIST") only.  
Select the sweep synchronization.

Analyzer synchronization:  
The sweep continues after a valid measured value has been obtained; recommended in generator/analyzer mode.

Time synchronization with fixed time:  
The sweep continues after a specified time has elapsed. The time is defined in menu item "Dwell". Required for sweeps with external analyzer.

Time synchronization using times specified in a list:  
The sweep continues after specified times which are read out of a list and interpolated on the basis of the existing X-axis.  
Required for sweeps with external analyzer, if the measuring or settling time of the analyzer and/or the DUT depends on the respective sweep point.

**Dwell File**

With automatic sweep ("Sweep Ctrl → AUTO LIST") and list-controlled time synchronization ("Next step → DWELL FILE") only.  
Specify a file containing the dwell times

The file is opened and loaded into an internal buffer.

If the name entered is not valid (drive not ready, file not found, invalid format, etc.), an error message is output and the reason for the fault is entered into the menu line.

For entry of file names, see 2.3.2.5; for generation of the list, see 2.9.1.2 Loading and Storing of Traces and Lists.

**Dwell**

Only with automatic sweep and list-controlled time synchronization ("Next step → Dwell:value").

Enter a dwell time for all sweep points.

Specified range: 0 to 1000 s.  
Units: s | ms | μs | min  
Resolution: 1 ms

X Axis	
	With an active sweep system only.
VOLT	Select the sweep parameter (one-dimensional sweep) or the 1st sweep parameter (two-dimensional sweep). Signal voltage (SINE, SINE BURST, SINE <sup>2</sup> BURST) or total voltage (MOD DIST, DFD) is swept.
FREQ	Signal frequency (SINE, SINE BURST, SINE <sup>2</sup> BURST), useful frequency (MOD DIST) or center frequency (DFD) is swept.
ON TIME	Time of high level with burst signals is swept.
INTERVAL	Interval time with burst signals is swept.

Z Axis	
	With active sweep system, only Select the 2nd sweep parameter for a two-dimensional sweep.
OFF	Sweep is one-dimensional
VOLT	Sweep is two-dimensional, the 2nd. sweep parameter is the signal voltage (SINE, SINE BURST, SINE <sup>2</sup> BURST) or total voltage (MOD DIST, DFD).
FREQ	Sweep is two-dimensional, the 2nd sweep parameter is the signal frequency (SINE, SINE BURST, SINE <sup>2</sup> BURST, SQUARE), wanted frequency (MOD DIST) or center frequency (DFD).
ON TIME	Sweep is two-dimensional, the 2nd sweep-parameter is the time of the high level (only with burst signals).
INTERVAL	Sweep is two-dimensional, the 2nd sweep parameter is the interval time (only with burst signals).

**Note:** *With two-dimensional sweeps of "ON TIME" and "INTERVAL", the minimum value of "INTERVAL" must exceed the maximum "ON TIME" value. With normal sweep, this is ensured by limitation and, if required, correction of the start and stop values with entry already. However, with list sweep, the user should make sure that this condition is met in the lists used, since a required, automatic correction is not carried out until the sweep is running - thus, unexpected results may be obtained.*

**Note:** *Theoretically, the same parameter may be entered for the X and Z axes (e.g., VOLT in both directions) - and this is not prohibited in the operator surface. This does, however, not make sense in normal practical use*



**Spacing**

- LIN POINTS**
- LIN STEPS**
- LOG POINTS**
- LOG STEPS**

With normal sweep only  
 (Sweep Ctrl → AUTO SWEEP or Sweep Ctrl → MANU SWEEP);  
 Determine the sweep range spacing.

The sweep range is linearly divided by a number of points to be specified.  
 The number is entered under menu item "Points".

Beginning from "Start", the sweep range is divided into intervals using a  
 linear step size to be specified under menu item "Step".

The sweep range is logarithmically divided by a number of points to be  
 specified. The number is entered under menu item "Points".

Beginning from "Start", the sweep range is divided into intervals using a  
 logarithmic step size to be specified under menu item "Step" (multiplier  
 without unit)

**Note:** No conversion is performed when switching from ... POINTS to ...STEPS and vice versa; the set values are retained in the back-ground. The numeric value for "STEP" remains the same when switching between LIN STEPS and LOG STEPS.

**Start**

With normal sweep only  
 (Sweep Ctrl → AUTO SWEEP or Sweep Ctrl → MANU SWEEP)  
 Enter the start value for the (above) sweep parameter.  
 Specified range, unit and resolution: as for the appertaining sweep  
 parameter.  
 If a start value is entered that is identical with the stop value, the stop  
 value is automatically loaded with the old start value.  
 In this way, the sweep direction can be easily reversed by means of a  
 single entry.

**Note:** The start value of the sweep parameter is set in the instrument  
 hardware with entry already (not with starting the sweep). The settling  
 time with starting the sweep can thus be minimized.

**Stop**

With normal sweep only  
 (Sweep Ctrl → AUTO SWEEP or Sweep Ctr → MANU SWEEP)  
 Enter the stop value for the (above) sweep parameter  
 Specified range, unit and resolution: as for the appertaining sweep  
 parameter.  
 If a stop value is entered that is identical with the start value, the start  
 value is automatically loaded with the old stop value.  
 In this way, the sweep direction can be easily reversed by means of a  
 single entry.

**Points**

With normal sweep only  
(Sweep → AUTO SWEEP or Sweep Ctrl → MANU SWEEP) and  
Spacing → LIN POINTS or Spacing → LOG POINTS selected.

Specified range: 2 to 1024.  
Units: None (integer)

Enter the number of sweep points for the (above) sweep parameter. The sweep range is divided into (points - 1) steps. 2 points at least (start and stop value) are required.

**Step**

With normal sweep only  
(Sweep Ctrl → AUTO SWEEP or Sweep Ctrl → MANU SWEEP) and  
Spacing → LIN STEPS or Spacing → LOG STEPS selected.

Enter the step size for the (above) sweep parameter.

With *linear* step, the absolute step size is always entered, i.e., the number value is positive even, if the start value exceeds the stop value.

With logarithmic step, the multiplication factor is entered, which is required for each sweep point to obtain the next sweep point. If start and stop value are interchanged (reversal of the sweep direction), the reciprocal value is constituted.

Specified range: see operator guidance line. The step size is to be selected as high as to result in not more than 1023 individual steps.

Unit and resolution: With linear spacing as for the appertaining sweep parameter. With logarithmic spacing, no unit can be entered (factor without unit).

**Exception:** *In the case of voltage sweeps (x-axis Volt), the logarithmic scaling can be entered either as a factor or in dB.*

**FREQ FILE**

With list sweeps only (Sweep Ctrl → AUTO LIST or  
Sweep Ctrl → MANU LIST)

Enter a file name for the frequency list. For the entry of file names see 2.3.2 Data Entry

The signal frequency (SINE, SINE BURST, SINE<sup>2</sup> BURST), the useful frequency (MOD DIST) or the center frequency (DFD) is swept.

**VOLT FILE**

With list sweeps only (Sweep Ctrl → AUTO LIST or  
Sweep Ctrl → MANU LIST)

Enter a file name for the amplitude list. For the entry of file names see 2.3.2 Data Entry

The signal voltage (SINE, SINE BURST, SINE<sup>2</sup> BURST) or the total voltage (MOD DIST, DFD) is swept.

**ONTIM FILE**

With list sweeps only (Sweep Ctrl → AUTO LIST or  
Sweep Ctrl → MANU LIST)

Enter a file name for the "ON-time" list of burst signals. For the entry of  
file names see 2.3.2 Data Entry

The burst duration (SINE BURST, SINE<sup>2</sup> BURST) is swept.

**INTV FILE**

With list sweeps only (Sweep Ctrl → AUTO LIST or  
Sweep Ctrl → MANU LIST)

Enter a file name for the interval list of burst signals. For the entry of file  
names see 2.3.2 Data Entry

The burst interval (SINE BURST, SINE<sup>2</sup> BURST) is swept.

2.5.4.3 SINE

**Frq Offset**

See 2.5.4.1 Common Parameters for the Generator Signals.

**Dither**

For digital generators only;  
See 2.5.4.1 Common Parameters for the Generator Signals.

**PDF**

For digital generators only;  
See 2.5.4.1 Common Parameters for the Generator Signals.

**Low Dist**

(Low-distortion generator) for the analog generator only.

**ON**  
**OFF**

Activating/Deactivating the low-distortion generator (see 2.5.1 Selecting th Generator)

(with UPL-B1 option only);  
the sine is generated by the low-distortion generator.

The sine is generated by the universal generator.

**DC Offset**

see 2.5.4.1.2 Common Parameters for All Generator Functions.

**SWEEP CTRL**

see 2.5.4.2 Sweeps

**Frequency**

Entry of the sine frequency; can be used as sweep parameter.  
Specified range: 10 Hz to  $f_{max}$

$f_{max}$  generator-dependent; cf. 2.5.1 Selecting the Generator

Resolution: 1 MHz

Unit: Hz | kHz | ΔHz | ΔkHz | f/fr | Δ%Hz | Toct | Oct | Dec

**Equalizer**

see 2.5.4.1.3 Equalization of SINE, SINE BURST, DFD, MULTISINE, RANDOM

**ON**  
**OFF**

The sine voltage is corrected.

Equalizer switched on. Menu item "Equal. file" is activated, i.e. the file indicated there is loaded.

Output voltage not affected.

**Equal. file**

(Equalizer file)  
with Equalizer → ON only;  
see 2.5.4.1.3 Equalization of SINE, SINE BURST, DFD, MULTISINE, RANDOM



### 2.5.4.4 MULTISINE

Up to 17 single sine voltages can be superposed on each other.

The phase angles of the single sine voltages are automatically optimized such that the maximum total peak value is as low as possible. The resulting total peak value thus being frequency-dependent, the voltage may increase when varying individual frequencies. The set maximum voltage ("Max volt", see 2.5.2 Configuration of the Analog Generator / 2.5.3 Configuration of the Digital Generator) is however never exceeded since the worst case is taken as the basis for linear superposition when entering the single voltages.

Further **special multi-tone signals** are selected using the functions

- MOD DIST (2 sinewave amplitudes with the ratios 1:1 to 10:1)
- DFD (2 equivalent sinewave amplitudes)
- SINE (1 sinewave with any amplitude)
- RANDOM, domain FREQ (7488 sinewave lines at fixed frequency offset with any amplitude)

With the first 3 functions, a "Frq Offset" or (with digital generator), in addition, "Dither" with "PDF" can be set.

**Note:**

- *The generator is interrupted while calculating a new multi-tone signal. The output signal is definitely set to 0 V or 0 FS.*

**DC Offset**

see 2.5.4.1.2 Common Parameters for All Generator Functions

**Spacing**

Set the frequency spacing:

**USER DEF**

The value entered is corrected to the next settable value.

The specified range depends on the selected generator and its sample rate (see 2.5.1 Selecting the Generator):

Lower limit:

- ANLG: 2.9 Hz
- DIG instruments: Int. sample frequency / 16384

Units: Hz, kHz

**ANLR TRACK**

The value for the FFT analysis frequency spacing is automatically adopted. The value is also displayed in the ANALYZER panel under "FFT:Resolution" (see 2.6.5.12 FFT). This setting is ideal for an analysis using the rectangular window. With no FFT selected in the analyzer, the setting is rejected (error message!).

<p><b>Equalizer</b></p>	<p>see 2.5.4.1.3 Equalization of SINE, SINE BURST, DFD, MULTISINE, RANDOM</p>
<p><b>ON</b></p> <p><b>OFF</b></p>	<p>Each active frequency line is corrected.</p> <p>Equalizer switched on. Menu item "Equal. file" is activated, i.e. the file indicated there is loaded.</p> <p>The output voltage of all frequency lines is not affected.</p>
<p><b>Equal. file</b></p>	<p>(Equalizer file) with Equalizer → ON; see 2.5.4.1.3 Equalization of SINE, SINE BURST, DFD, MULTISINE, RANDOM</p>
<p><b>Mode</b></p>	<p>Select the input mode for the individual sine voltages:</p>
<p><b>EQUAL VOLT</b></p> <p><b>DEFINE VOLT</b></p>	<p>The same amplitude applies for each single sine; it is entered as "Volt No1".</p> <p>An individual amplitude can be defined for each single sine.</p>
<p><b>Crest Fact</b></p>	<p>Selects the algorithm for determining the phase of individual sinewaves and thus of the crest factor of the complete signal. This menu item is only displayed with option UPL-B6 installed.</p>
<p><b>OPTIMIZED</b></p> <p><b>VALUE:</b></p> <p><b>DEFINE PHAS</b></p>	<p>The crest factor is automatically <i>minimized</i> by internally optimizing the individual phases.</p> <p>Definition of <i>desired crest factor</i>. The phase of the individual sinewaves are modified internally so that the resulting crest factor closely approaches the desired value. The accuracy of this method depends on the number of lines.</p> <p>Entry of <i>phases</i> of all active sine lines.</p>

**No of sine**

Specified range: 1 to 17  
Units: none

Entry of number of desired tones, i.e. the number of sines to be edited. In EQUAL VOLT mode, the entry also influences the maximum amplitude that can be entered for a single sine tone (see "Volt No (i)").

For a better overview, settings for up to 17 frequencies and levels are not made in the GENERATOR panel, but in a special dialog window, which is opened automatically with selection of "No of sine" or command "Choice ..." below. In this window, the individual frequency, phase and level menu items can be copied into the STATUS panel by ticking them off. Subsequent to closing the window, they can be displayed and entered in the STATUS panel.

**Choice ...**

Opens a special dialog window where the individual sine frequencies and levels can be displayed and entered in a clearly arranged form.

All frequency and level items marked in the menu of this window are transferred into the STATUS panel where they can be displayed and entered even after this window has been closed.

**Note:** *The dialog window described here is also automatically opened when "No of sine" is entered.*

**Freq No (i)**

Enter the sinewave frequency  $i$  ( $i = 1$  to 17)

Specified range:  $f_{\min}$  to  $f_{\max}$  (depending on generator)

$f_{\min}$ : Value from spacing

$f_{\max}$ : see 2.5.1 Selecting the Generator

Units: Hz | kHz |  $\Delta$ Hz |  $\Delta$ kHz | f/fr |  $\Delta$ %Hz | Toct | Oct | Dec

The single frequencies may lie as close to each other as desired or may even be superposed on each other (taking the resolution into account).

**Phase No (i)**

Entry of phase of individual sinewave  $i$  ( $i = 1$  to 17)

This menu item is only displayed when software option UPL-B6 is installed and DEF PHASE was selected as crest factor.

The reference point is the assumed time  $T_0$ , where all sinewaves start with the phase 0.

If sinewave No. 1 is to be used as reference frequency, it must be assigned the phase 0.

Specified range: 0 to 360°

Unit: ° or RAD

If two or more individual lines have the same frequency, i.e. are superimposed, the first of the two lines determines the (common) phase which is assigned to all subsequent frequency lines.



**Volt No (i)**

Enter the sinewave amplitude i (i = 1 to 17)

Specified range: the total voltage  $V_{max}$  reduced by the dc voltage is available for each of n single sines (n = "No of sin", 1 to 17). To avoid overranging the (phase-optimized) overall signal may be reduced by reducing the post-amplification.

digital (audio data or phase mode):

$$V_{max} = 1 \text{ FS}$$

(jitter mode):  $V_{max} = 2.5 \text{ UI}$

(comm mode):  $V_{max} = 7.071 V_{rms}$

analog:  $V_{max} = 10 V_{rms}$  for UNBAL

$$V_{max} = 20 V_{rms}$$
 for BAL

**Note:** Voltage limitation of the rms value by menu item "Max volt", see 2.5.2 Configuration of the Analog Generator / 2.5.3 Configuration of the Digital Generator

$V_{max}$  is split up into the single sine voltages as follows:

- in EQUAL VOLT mode, any sine may be as large as  $(V_{max} \text{ DC})/n$
- in DEFINE VOLT mode, any sine may be as large as the difference between  $(V_{max} \text{ DC})$  and the sum of all other active single sines

Units:

digital (audio data or phase mode):

FS | %FS | dBFS | LSBs | bits | Δ% | dBr

digital (jitter mode):

UI | %UI | dBUI | ppm | ns | UIr | dBr

analog and digital common mode:

V | mV | μV |  $V_{pp}$  |  $mV_{pp}$  |  $\mu V_{pp}$  |  $V/V_r$  | dBu | dBV |

dBr | dBm | Δ%V | ΔV | ΔmV | ΔμV

peak-to-peak amplitude (analog):  $V_{pp} = V_{rms} \times 2 \times \sqrt{2}$ ;

**Total Gain**

Entry of a gain factor (in dB), which allows to vary the rms value resulting from superimposition of the individual voltages. To avoid overranging the permitted range of values is varied such that the resulting overall signal does not exceed the permitted (or possible) generator output level.

Unit: dB

**TOTAL PEAK**

Read only, no input field

Indicates total peak value of multi-tone signal. The value is usually below of the single peak values due to internal phase optimization

Units: digital (audio data or phase mode):

FS | %FS | dBFS | LSBs | bits

digital (jitter mode):

UI | %UI | dBUI | ppm | ns

analog and digital common mode:

V | mV | μV | dBu | dBV | dBm

<b>TOTAL RMS</b>	<p>Read only, no input field (only analog) Indicates total rms value of multi-tone signal.</p>
<b>Ampl Var</b>	<p>Selection of the type of modulation, see 2.5.4.1.4 Amplitude Variation of MULTISINE, RANDOM and ARBITRARY</p>
<p><b>OFF</b></p> <p><b>SINE</b></p> <p><b>BURST</b></p>	<p>The amplitude modulation is switched off, the generator signal is not modulated.</p> <p>The generator signal is amplitude-modulated in the form of a sinewave from 0% to -100%.</p> <p>The generator signal is switched on and off periodically;</p>
<b>Mod Freq</b>	<p>with "Ampl Var SINE", only: setting of the modulation frequency; see 2.5.4.1.4</p>
<b>Variation</b>	<p>with "Ampl Var SINE", only: setting of the variation in %, see 2.5.4.1.4.</p>
<b>ON TIME</b>	<p>with "Ampl Var BURST", only: entry of the burst duration, see 2.5.4.1.4.</p>
<b>INTERVAL</b>	<p>with "Ampl Var BURST", only: entry of the burst-interval length (burst period) , see 2.5.4.1.4.</p>

### 2.5.4.5 SINE BURST

Sine periodically varying between high and low level. Like the normal sine, the signal can optionally be equalized.

**Equalizer**

**ON**  
**OFF**

see 2.5.4.1.3 Equalization of SINE, SINE BURST, DFD, MULTISINE, RANDOM

The sine voltage is equalized.

Equalizer is switched on. The menu "Equal. file" is activated, i.e., the file indicated there is loaded.

output voltage is not influenced

**Equal. file**

(Equalizer file) only, if equalizer → ON

see 2.5.4.1.3 Equalization of SINE, SINE BURST, DFD, MULTISINE, RANDOM.

**DC Offset**

see 2.5.4.1.2 Common Parameters for All Generator Functions

**SWEEP CTRL**

see 2.5.4.2 Sweeps.

**FREQUENCY**

Entry of the sine frequency; can be used as sweep parameter; see 2.3.2 Data Entry

Specified range: 10 Hz to  $f_{max}$

$f_{max}$  depending on generator; see 2.5.1 Selecting the Generator

Resolution: 1 MHz

Units: Hz | kHz | ΔHz | ΔkHz | f/fr | Δ%Hz | Toct | Oct | Dec

Side-effect: ON TIME is adjusted, if required.

## VOLTAGE

Entry of the high-level sine amplitude, i.e. the amplitude during burst time; can be used as sweep parameter; see 2.3.2.5.

Specified range: 0 to  $V_{\max}$

digital:  $V_{\max} = 1 \text{ FS}$

analog:  $V_{\max} = 10 V_{\text{rms}}$  for UNBAL

$V_{\max} = 20 V_{\text{rms}}$  for BAL

**Note:** Voltage limitation of the rms value by menu item "Max volt", see 2.5.2 Configuration of the Analog Generator / 2.5.3 Configuration of the Digital Generator

Units: digital (audio data mode):

FS | %FS | dBFS | LSBs | bits |  $\Delta\%$  | dBr

analog:

V | mV |  $\mu\text{V}$  |  $V_{\text{pp}}$  |  $\text{mV}_{\text{pp}}$  |  $\mu\text{V}_{\text{pp}}$  |  $V/V_r$  |

dBu | dBV | dBr | dBm |

$\Delta\%V$  |  $\Delta V$  |  $\Delta\text{mV}$  |  $\Delta\mu\text{V}$

peak-to-peak amplitude (analog):  $V_{\text{pp}} = V_{\text{rms}} \times 2 \times \sqrt{2}$ ;

Side effect: Low Level is adjusted, if required.

## Low Level

Enter the low-level sine amplitude, i.e. the amplitude during OFF time.

Specified range: 0 to high level (VOLTAGE)

Units:

digital (audio data mode):

FS | %FS | dBFS | LSBs | bits |  $\Delta\%$  | dBr |

%on | dBon

analog:

V | mV |  $\mu\text{V}$  |  $V_{\text{pp}}$  |  $\text{mV}_{\text{pp}}$  |  $\mu\text{V}_{\text{pp}}$  |  $V/V_r$  |

dBu | dBV | dBr | dBm | V/on | %on | dBon |

$\Delta\%V$  |  $\Delta V$  |  $\Delta\text{mV}$  |  $\Delta\mu\text{V}$

**As to the unit:** In addition to the standard voltage specifications (absolute or relative to the reference value), further relative units referring to high level can be used. They are

%on, dBon; in the analog range also V/on

If a unit of this kind is selected, the ratio

"low level : high level"

is always kept constant when the high level is varied. This means that changing VOLTAGE (also during a sweep) changes the low level, too.

With all other units, varying VOLTAGE affects the low level only when VOLTAGE becomes smaller than the low level.

peak-to-peak amplitude (analog):  $V_{\text{pp}} = V_{\text{rms}} \times 2 \times \sqrt{2}$ ;

**ON TIME**

Entry of the burst duration, i.e. the time during which the sine has its high level; can be used as sweep parameter.

Specified range:      lower limit:      (1 sample)  
                                  analog:               $t_{\min} = 20.83 \mu\text{s}$   
                                  digital:            $t_{\min} = 1 / \text{sample}_{\text{Frq}}$   
                                  upper limit:      60 s -  $t_{\min}$   
 Unit:                              s | ms |  $\mu\text{s}$  | cyc | kcyc | Mcyc

**Side effect:** *Entering a burst duration exceeding the length of an interval causes the interval length to be increased to burst duration.*

**Note as to the unit:** *Apart from standard time specifications, the burst duration can also be specified in cycles. The selection of this unit, which is relative to frequency, results in the number of cycles - and not the burst time - remaining constant when the frequency is changed, i.e. increasing the frequency decreases the duration of the burst signal. If INTERVAL is not specified in cycles, the ratio ON-TIME : INTERVAL is reduced.*

**INTERVAL**

Entry of the burst interval length; can be used as sweep parameter.

Specified range:      lower limit:      set burst duration.  
                                  upper limit:      60 s  
 Units:                              s | ms |  $\mu\text{s}$  | cyc | kcyc | Mcyc | min

**Note as to the unit:** *Apart from standard time specifications, the burst interval can also be specified in cycles. The selection of this unit, which is relative to frequency, results in the number of cycles - and not the interval time - remaining constant when the frequency is changed, i.e. increasing the frequency decreases the interval of the burst signal, If the ON TIME is not specified in cycles, the ratio ON-TIME : INTERVAL is increased.*

**Note:** *If generator settings are modified or a measurement is (re-)started, the generator is automatically restarted and starts the interval (considering the Burst On Delay) with ON TIME, i.e. with High Level.*

**BurstOnDel**

(Burst on delay)

When starting the generator (e.g., subsequent to changing or acknowledging the function) or starting the measurement, the burst signal normally adopts the "burst on"-state, i.e. the high level. Certain applications, however, require the high level state to be delayed, e.g., in order to trigger to the high level. The start delay of the burst signal is intended to be used for these applications; the generator puts out the low level.

Specified range:      0 to 60 s

### 2.5.4.6 SINE<sup>2</sup> BURST

Sine<sup>2</sup>-wave signal which is periodically switched on and off. Either positive or negative pulses (also partial pulses) can be generated (by entering a negative voltage). Typically, the signal is not DC-free.

#### DC Offset

see 2.5.4.1.2 Common Parameters for All Generator Functions

#### SWEEP CTRL

see 2.5.4.2 Sweeps

#### FREQUENCY

Entry of the sine<sup>2</sup>-wave frequency; can be used as sweep parameter; see 2.3.2 Data Entry

Specified range: 10 Hz to  $f_{\max}$   
 $f_{\max}$  depending on generator;  
 see 2.3.2 Selecting the Generator

Units: Hz | kHz |  $\Delta$ Hz |  $\Delta$ kHz | f/ $f_r$  |  $\Delta$ %Hz | Terz  
 Oct | Dec

Resolution: 1 MHz

**Note:** The period of this signal is defined as the time required for a pulse.

Side effect: "ON TIME" is adjusted, if required.

#### VOLTAGE

Entry of the sine<sup>2</sup>-wave amplitude; can be used as sweep parameter.

Specified range: 0 to  $V_{\max}$   
 digital:  $V_{\max} = 1 \text{ FS}$   
 analog:  $V_{\max} = 10 V_{\text{rms}}$  for UNBAL  
 $V_{\max} = 20 V_{\text{rms}}$  for BAL

Units:  
 digital (audio data mode):  
 FS | %FS | dBFS | LSBs | bits |  $\Delta$ % | dBr  
 analog:  
 V | mV |  $\mu$ V |  $V_{\text{pp}}$  |  $mV_{\text{pp}}$  |  $\mu V_{\text{pp}}$  |  $V/V_r$  |  
 dBu | dBV | dBr | dBm |  
 $\Delta$ %V |  $\Delta$ V |  $\Delta$ mV |  $\Delta$  $\mu$ V

**Note:** Voltage limitation of the rms value by means of menu item "Max volt", see 2.5.2 Configuration of the Analog Generator / 2.5.3 Configuration of the Digital Generator

As to the unit: When entering negative voltages, the pulse is inverted. Conversion into logarithmic units (dBFS, dBu, dBr, dBV) is not possible in this case.

peak-to-peak amplitude (analog):  $V_{\text{pp}} = V_{\text{rms}} \times 2 \times \sqrt{2}$ ;

$V_{\text{rms}}$  is the rms value during pulse time, the level during OFF time is not considered when calculating the rms value.

**ON TIME**

Entry of the pulse duration, i.e. the time the sine<sup>2</sup> is switched on; can be used as sweep parameter; see 2.3.2 Data Entry

Specified range:      lower limit:      (1 sample)  
    analog:               $t_{\min} = 20.83 \mu\text{s}$   
    digital:             $t_{\min} = 1 / \text{sample}_{\text{frq}}$   
    upper limit:       $60 \text{ s} - t_{\min}$

Units:                      s | ms |  $\mu\text{s}$  | cyc | kcyc | Mcyc | min

**Side effect:** Specifying a burst duration longer than the interval length causes the latter to be increased to burst duration.

**As to the unit:** Apart from standard time specifications, the pulse duration can also be specified in cycles. The selection of this unit, which is relative to frequency, results in the number of cycles - and not the pulse time - remaining constant when the frequency is changed, i.e. increasing the frequency decreases the pulse duration. If the INTERVAL is not entered in cycles, the ratio ON-TIME : INTERVAL is reduced.

**INTERVAL**

Entry of the interval length; can be used as sweep parameter; see 2.3.2 Data Entry

Specified range:      lower limit:      set burst duration  
    upper limit:      60 s

Units:                      s | ms |  $\mu\text{s}$  | cyc | kcyc | Mcyc | min

**As to the unit:** Apart from standard time specifications, the pulse interval can also be specified in cycles. The selection of this unit, which is relative to frequency, results in the number of cycles - and not the pulse time - remaining constant when the frequency is changed, i.e. increasing the frequency decreases the interval length of the burst signal. If the ON TIME is not entered in cycles, the ratio ON-TIME : INTERVAL increases.

**Note:** If generator settings are modified or a measurement is (re-)started, the generator is automatically restarted and starts the interval (considering the Burst On Delay) with ON TIME.

**BurstOnDel**

(Burst On Delay)

When starting the generator (e.g., subsequent to changing or acknowledging the function) or starting the measurement, the burst signal normally adopts the "burst on"-state, i.e. the high level. Certain applications, however, require the high level state to be delayed, e.g., in order to trigger to the high level. The start delay of the burst signal is intended to be used for these applications; the generator puts out the low level.

Specified range:      0 to 60 s

### 2.5.4.7 MOD DIST (Two-tone Signal to SMPTE)

Superposing 2 sinewave signals: low-frequency interfering signal and high-frequency useful signal; interfering signal is 1 to 10 times stronger than useful signal.

For intermodulation measurements to SMPTE (Society of Motion Picture and Television Engineers) and modulation distortion analysis to .

#### Frequencies

- Recommendation DIN 45403, sheet 4: or DIN-IEC 268-3:  
interfering signal  
 $f1 <= 1.4 \times$  lower limit frequency of DUT  
 $f1 >= 31.5$  Hz  
 useful signal  $f2$   
 $f2 >= 0.7 \times$  upper limit frequency of DUT  
 $f2 >= 8 \times f1$
- SMPTE standard:  
interfering signal:  $f1 = 60$  Hz  
useful signal:  $f2 = 7$  kHz

Amplitude ratio interfering signal : useful signal:  
4:1 (SMPTE); to DIN, 10:1 is also possible

With the LDG option fitted, the useful signal in the analog range can be generated by the universal generator or, alternatively, by the low-distortion generator.

#### Notes:

- For intermodulation measurements to MOD DIST, an appropriate measurement function is to be set in the ANALYZER panel (see 2.6.5.8).
- If the selection "Function tracking Gen → Anl" is ticked off in the OPTIONS panel under menu item "Param Link", the measurement function MOD DIST is switched on in conjunction with the function changeover of the generator to MOD DIST:

<b>Frq Offset</b>	See 2.5.4.1 Common Parameters for the Generator Signals
<b>Dither</b>	For digital generators only; see 2.5.4.1 Common Parameters for the Generator Signals  <b>UPL-B29:</b> The dither generator can be switched on in the base rate mode only.
<b>PDF</b>	For digital generators only; see 2.5.4.1 Common Parameters for the Generator Signals
<b>DC Offset</b>	see 2.5.4.1 Common Parameters for the Generator Signals
<b>SWEEP CTRL</b>	see 2.5.4.2 Sweeps



**UPPER FREQ**

Entry of the upper useful frequency; can be used as sweep parameter.  
see

Specified range: 240 Hz to  $f_{max}$

$f_{max}$  depending on generator; see 2.5.1

Units: Hz | kHz | ΔHz | ΔkHz | f/fr | Δ%Hz | Toct | Oct | Dec

Resolution: 1 MHz (50 Hz for DIG 768 kHz)

**LOWER FREQ**

Entry of the interfering frequency; can be used as sweep parameter.

Specified range: 30 Hz to UPPER FREQ / 8

Units: Hz | kHz | ΔHz | ΔkHz | f/fr | Δ%Hz | Toct | Oct | Dec

Resolution: 1 MHz

**VOLT LF:UF**

Enter the ratio interfering level : useful level as a real number.

Specified range: 1.0 to 10.0

In the analog range, this ratio affects the level of the total rms voltage which can be input via "TOTAL VOLT".

Unit: none

## TOTAL VOLT

Entry of the total amplitude of both sinewave signals; can be used as sweep parameter.

Specified range:

digital: 0 to 1 FS

analog: 0 to 10.964  $V_{\text{rms}}$  for UNBAL

0 to 21.927  $V_{\text{rms}}$  for BAL

**Note:** The selectable analog voltage depends on the voltage ratio "Volt LF:UF"; specifications refer to a voltage ratio of 10:1.

**Note:** Voltage limitation of the rms value by means of menu item "Max volt", see 2.5.2 Configuration of the Analog Generator / 2.5.3 Configuration of the Digital Generator

Units:

digital (audio data mode):

FS | %FS | dBFS | LSBs | bits |  $\Delta\%$  | dBr

analog:

V | mV |  $\mu\text{V}$  |  $V_{\text{pp}}$  |  $\text{mV}_{\text{pp}}$  |  $\mu\text{V}_{\text{pp}}$  |  $V/V_r$  |

dBu | dBV | dBr | dBm |

$\Delta\%V$  |  $\Delta V$  |  $\Delta\text{mV}$  |  $\Delta\mu\text{V}$

In the analog range, the maximum peak voltage is  $\sqrt{2} \times 10$  V (UNBAL) or  $\sqrt{2} \times 20$  V (BAL). Hence, the following restriction applies:

$$V_{\text{pp}} \leq 28,284 V_{\text{pp}} \text{ (UNBAL) or}$$

$$V_{\text{pp}} \leq 56,569 V_{\text{pp}} \text{ (BAL)}$$

$$V_{\text{pp}} = V_{1\text{pp}} + V_{2\text{pp}}$$

The total voltage is divided into useful signal and interfering signal in a (selectable) ratio. The maximum total rms voltage, which is obtained from the square sum of the single rms values, thus depends on the level ratio interfering signal : useful signal. The specifications for the specified range stated above are relative to the ratio 10 : 1. The closer the ratio comes to the value 1 : 1, the lower the maximum obtainable total rms voltage. With 1 : 1, it is 7,0711  $V_{\text{rms}}$  (UNBAL) or 14,142  $V_{\text{rms}}$  (BAL).

As a rule, the relationship between total peak-to-peak voltage and total rms voltage can be expressed as follows:

$$V_{\text{pp}} = \frac{V_{\text{eff}} \times 2 \times \sqrt{2} \times (k+1)}{\sqrt{(k^2+1)}}; \quad k = \text{"VOLT LF:UF"}$$

### 2.5.4.8 DFD (Difference Frequency Distortion)

Two closely spaced sinewave signals of the same amplitude; for intermodulation measurements (DFD method to DIN-IEC 268-3, former DIN 45403, Sheet 3).

With the LDG option fitted, the low-frequency sinewave in the analog range can be produced by the function generator or, alternatively, the low-distortion generator.

**Note:** For intermodulation measurements to DFD, an appropriate measurement function is to be set in the ANALYZER panel (see 2.6.5.9).

**Note:** If the selection "Function tracking Gen → Anl" is ticked off in the OPTIONS panel under menu item "Param Link", the measurement function MOD DIST is switched on in conjunction with the function changeover of the generator to MOD DIST:

<b>Frq Offset</b>	see 2.5.4.1 Common Parameters for the Generator Signals
<b>Dither</b>	For digital generators only; see 2.5.4.1 Common Parameters for the Generator Signals
<b>PDF</b>	For digital generators only; see 2.5.4.1 Common Parameters for the Generator Signals
<b>DC Offset</b>	see 2.5.4.1.2 Common Parameters for All Generator Functions
<b>Equalizer</b>	see 2.5.4.1.3 Equalization of SINE, SINE BURST, DFD, MULTISINE, RANDOM. Each of the two difference tone frequencies is corrected.
<b>ON</b>	Equalizer switched on. The menu item "Equal. file" is loaded, i.e. the indicated file is loaded. It may happen that the two (equal) sine voltages are weighted with different correction factors so that they are no longer recognized as DFD signal by the analyzer. If an error message of this kind is displayed, switch to the IEC 118 measurement mode which is more tolerant to differences of the DFD lines.
<b>OFF</b>	The output voltage of the two difference tone frequencies is not affected.
<b>Equal. file</b>	(Equalizer file) with Equalizer → ON only; see 2.5.4.1.3 Equalization of SINE, SINE BURST, DFD, MULTISINE, RANDOM.

<b>Mode</b>	Selection of entry mode for DFD frequencies.
<b>IEC 268</b>	Entry of center frequency (MEAN FREQ) and difference frequency (DIFF FREQ). If a frequency sweep is selected (for the X or Z axis), the center frequency is swept.
<b>IEC 118</b>	Entry of upper DFD frequency (UPPER FREQ) and difference frequency (DIFF FREQ). If a frequency sweep is selected (for the X or Z axis), the UPPER FREQ is swept.
<b>Note:</b> <i>When measuring the DFD, one of the two standards can be selected under the menu item "Meas Mode".</i>	
<b>SWEEP CTRL</b>	see 2.5.4.2 Sweeps
<b>MEAN FREQ</b>	Entry of the mean frequency; can be used as sweep parameter.  Specified range: 200 Hz to ( $f_{\max}$ - 500 Hz) $f_{\max}$ depending on generator; see 2.5.1 Selecting the Generator Units: Hz   kHz   $\Delta$ Hz   $\Delta$ kHz   f/fr   $\Delta$ %Hz   Toct   Oct   Dec Resolution: 1 MHz;
<b>DIFF FREQ</b>	Enter the frequency difference between both sines  Specified range: 80 Hz to 0.55 * MEAN FREQ, max. 1 kHz $f_{\min}$ depending on generator; see 2.5.1 Selecting the Generator Units: Hz   kHz   $\Delta$ Hz   $\Delta$ kHz   f/fr   $\Delta$ %Hz   Toct   Oct   Dec Resolution: 1 MHz  Rec. to DIN-IEC 268-3: 80 Hz

## TOTAL VOLT

Entry of the total amplitude of both sinewave signals; can be used as sweep parameter, see 2.3.2.

Specified range: digital: 0 to 1 FS  
 analog: 0 to 8.485 V<sub>rms</sub> for UNBAL (BNC)  
 0 to 16.971 V<sub>rms</sub> for BAL (XLR)

**Note:** Voltage limitation of the rms value by means of menu item "Max volt", see 2.5.2 Configuration of the Analog Generator / 2.5.3 Configuration of the Digital Generator

Units:

digital (audio data mode):

FS | %FS | dBFS | LSBs | bits | Δ% | dBr

analog:

V | mV | μV | V<sub>pp</sub> | mV<sub>pp</sub> | μV<sub>pp</sub> | V/V<sub>r</sub> |

dBu | dBV | dBr | dBm |

Δ%V | ΔV | ΔmV | ΔμV

The maximum peak-to-peak voltage in the analog range is  $\sqrt{2} \times 10$  V (UNBAL) or  $\sqrt{2} \times 20$  V (BAL). Hence the following limitation applies:

$$U_{pp} \leq 28,284 V_{pp} \text{ (UNBAL) or}$$

$$U_{pp} \leq 56,568 V_{pp} \text{ (BAL)}$$

$$U_{pp} = U_{1pp} + U_{2pp}$$

With two equivalent single voltages  $U_{1pp} = U_{2pp}$ , the maximum permissible total rms voltage is:

$$U_{\text{eff}} = \sqrt{\left(\frac{U_{1pp}}{2 \cdot \sqrt{2}}\right)^2 \cdot 2} = \frac{U_{1pp}}{2} = \frac{U_{pp}}{4}$$

### 2.5.4.9 Random (Pseudo Noise)

Set generator signals which have the same or similar characteristics as noise (e.g. closely spaced sine lines in the frequency domain). There are two ways of defining these signals:

- Specify the amplitude density distribution in the time domain (Domain: TIME)
- Specify the amplitude frequency distribution in the frequency domain (Domain: FREQ)

This function is available in all generators.

**Note:**

- *The generator is interrupted while calculating a new noise signal. The output signal is definitely set to 0 V or 0 FS.*

DC Offset

see 2.5.4.1.2 Common Parameters for All Generator Functions

Domain

Selection of domain for definition of the noise signals

FREQ

Sine lines with settable amplitudes are generated and superposed on each other using defined frequency spacings to produce the output signal. In order to minimize the resulting peak value of the signal, each line is phase-optimized relative to the other lines. Minimum form factors (=peak/rms) can thus be obtained. Depending on the selectivity of the analyzer, the output signal is not displayed as a sequence of single lines, but as a noise signal with continuous level above the frequency. The frequency-defined noise allows for generating up to 7488 single tones with any amplitude (multitone).

**Special application:**

When the frequency spacing of the sine lines generated here **exactly** matches the analysis spacing used for the FFT, an FFT analysis is feasible without leakage. A selectivity of one line can thus be obtained with the square window. The setup consisting of this generator and analyzer allows you to precisely determine the frequency response of a device under test at one go. (see 2.6.7.3 Fast Frequency Response Measurement)

**Note:** *As the optimization is very compute-bound, a few seconds of computing time before the output is started may be required by the generator, especially with small frequency spacings and wide noise band. → Status display: "GEN: BUSY". Entering data while GEN: BUSY is being displayed aborts the computations and the generator enters the GEN:HALTED state. The generator restarts automatically.*

TIME

In this mode, noise signal generation is effected by nested random functions which have been optimized to produce evenly distributed noise. Periodicity is the case only after a runtime of at least 1 day.

**Spacing**

- USER DEF**
- ANLR-TRACK**

Definition of the frequency spacing, i.e. the space between the individual frequency lines:

(displayed with domain = Freq only)

The frequency spacing can be set manually. The value entered is corrected to the next settable value. The limits and settable frequency values depend on the sample rate (see 2.5.1 Selecting the Generator) and the selected generator. The lower frequency limit for the digital instruments is the ratio

$$\text{system clock rate} / 16384$$

Units: Hz, kHz

The value specified for the FFT analysis spacing is automatically adopted. The value is also displayed in the ANALYZER panel under "FFT:Resolution" (see 2.6.5.12 FFT). This setting is ideal for an analysis using the rectangular window. With no FFT selected in the analyzer, the setting is rejected (error message!).

**Shape**

- WHITE**
- PINK**
- THIRD OCT**
- FILE**

(displayed with Domain = FREQ only)

Specify the function which is used to determine the amplitudes of the single sine lines.

All the sine lines between start value (see below) and stop value have the same amplitude.

The amplitude of the sine lines between start and stop value is proportional to  $\sqrt{1/f}$

As PINK, however band-limited to  $1/3$  octave = 1 third-octave (TOCT) with settable mean frequency ("third-octave noise").

The amplitudes of the single lines are set using floating numbers which are read from a file.

**Shape File**

There are two different file formats for Domain FREQ: the ASCII file with the extension .FTF which is generally written by the user and the equalization file with the extension VEQ! which is normally generated from trace data (sweep or FFT). The latter is also offered in the basic setting in the file panel. It can however be overwritten by the user. - For Domain TIME, a file can't be loaded.

**File format 1:**

The file is a pure ASCII file where the amplitudes of the single frequency lines starting from 0 Hz are entered as floating numbers; the space between the lines is determined by "Spacing" which can be entered in the panel. The numbers specify only the amplitude ratio between the lines and not the output amplitude (which is determined after phase optimization using "VOLTAGE PEAK"). The file must have a line with the keyword 'FREQUENCY\_FILE' before the numbers. Comment lines begin with '#' and are allowed anywhere. No difference is made between upper-case and lower-case letters.

The preset type of file is '.FTF' (= frequency table file).

**Example:** 'r&s\_exam.ftf' in directory C:\UPL\USER.

**File format 2:**

The EQUALIZATN file in the file panel which was generated with Store Trace/List is used. The inverted form of a frequency response is generally used (Invert 1/n ON) so that, using this "pre-distorted" spectrum, a flat frequency response can be achieved after the DUT. Both of the formats ASCII and REAL can be loaded, the standard file extension is: VEQ!

**Using an equalization file which was obtained from an FFT:**

Feed the noise signal from the generator into the DUT, set an FFT with a rectangular window such that a closed trace (comparable with a sweep curve) results and save the FFT as an Equalization file. The essential settings in detail from left to right:

GENERATOR Panel:		ANALYZER Panel:		FILE Panel	
FUNCTION	RANDOM	FUNCTION	FFT	Store	EQUALIZATN
Domain	FREQ	Window		Invert 1/n	ON
			RECTANGULAR		
Spacing	ANLR TRACK			Filename	XXX.VEQ
Shape	WHITE				

To display the straightened trace, feed the noise signal including the shape file XXX.VEQ into the DUT.

GENERATOR Panel:	
FUNCTION	RANDOM
Domain	FREQ
Spacing	ANLR TRACK
Shape	FILE
Shape File	XXX.VEQ



**Equalizer**

ON

OFF

(displayed with FREQ domain only)

see 2.5.4.1.3 Equalization of SINE, SINE BURST, DFD, MULTISINE, RANDOM.

Each frequency line is corrected.

Equalizer switched off. The menu item "Equal. file" is activated, i.e. the file indicated there is loaded.

The set voltage (peak or RMS) and the calculated crest factor refer to the *non-equalized* total signal (as is the case with single and multi-tone signals). Therefore, the voltage measured at the outputs is not identical with the values for VOLT PEAK and VOLT RMS indicated in the GENERATOR panel.

The output voltage of all frequency components of the noise signal is not affected.

**Equal. file**

(Equalizer file)

with Equalizer → ON only;

see 2.5.4.1.3 Equalization of SINE, SINE BURST, DFD, MULTISINE, RANDOM.

**Crest Fact**

OPTIMIZED

VALUE:

(displayed with Domain Freq only)

Selects the algorithm for determining the phase position of the individual frequency lines and thus the crest factor of the complete signal.

Automatic *minimization* of crest factor by internally optimizing the individual phases.

Presetting a *desired crest factor*. The phase of the frequency lines is modified internally so that the resulting crest factor closely approaches the desired value. The accuracy of this method depends on the total number of lines thus spacing and frequency range

**Lower Freq**

(is displayed with Domain = FREQ, only)

Set the lower limit of the range for generated noise (with Shape WHITE and PINK). The limits for this setting are

$$f_{\text{ugr}} = 1 \times \text{spacing}$$

$$f_{\text{ogr}} = 117/256 \times \text{sampling rate} - 1 \times \text{spacing}$$

The values entered are rounded to integer multiples of "spacing".

**Upper Freq**

(is displayed with Domain = FREQ, only)

Set the upper limit of the range for generated noise (with Shape WHITE and PINK). The limits for this setting are

$$f_{\text{ugr}} = \text{Lower freq} + 1 \times \text{spacing}$$

$$f_{\text{ogr}} = 117/256 \times \text{sampling rate}$$

The values entered are rounded to integer multiples of "spacing"..

**MEAN FREQ**

(displayed with Domain = FREQ, Shape THIRD OCT))

Set the mean frequency at  $1/3$  octave. The output starts at the line next to the mean frequency/ 1.12246 and ends with the line next to the mean frequency x 1.12246.

**VOLT PEAK**

Set the peak output level.

VOLT PEAK and VOLT RMS are coupled via the crest factor (which is constant for a specific signal). A change of VOLT PEAK therefore immediately affects the figure for VOLT RMS. If the crest factor is changed, RND PEAK will remain unchanged.

Specified range: 0 to  $V_{\text{max}}$

digital:  $V_{\text{max}} = 1 \text{ FS}$

$$V_{\text{max}} = 10 \text{ V (Mode Common)}$$

$$V_{\text{max}} = 2,5 \text{ UI (Mode Jitter)}$$

analog:  $V_{\text{max}} = 14,142 \text{ V für UNBAL}$

$$V_{\text{max}} = 28,284 \text{ V für BAL}$$

Units:

digital (audio data or phase mode):

FS | %FS | dBFS | LSBs | bits |  $\Delta\%$  | dBr

digital (jitter mode):

UI | %UI | dBUI | ppm | ns | UIr | dBr

analog and digital common mode:

V | mV |  $\mu\text{V}$  |  $V/V_r$  | dBu | dBV | dBr | dBm |

$\Delta\%V$  |  $\Delta V$  |  $\Delta mV$  |  $\Delta \mu V$

**VOLT RMS**

Setting of rms output voltage (in the analog generator only).

VOLT PEAK and VOLT RMS are coupled via the crest factor (which is constant for a specific noise signal). A change of VOLT RMS therefore affects the VOLT PEAK value.

Units: V | mV |  $\mu$ V |  $V/V_r$  | dBu | dBV | dBr | dBm |  $\Delta\%V$  |  $\Delta V$  |  $\Delta mV$  |  $\Delta\mu V$

**Note:** *Entry of VOLT RMS is only possible when the generator is RUNNING. Since the crest factor is not yet known during calculation of the noise signal (GEN BUSY), the entry is at first rejected and the voltage 0.0 is entered. To ensure that the generator outputs a noise signal of correct (peak) amplitude after the calculation, VOLT PEAK should be entered, which is possible any time.*

**PDF**

(displayed with domain = TIME)

(PDF = probability density function) Select the amplitude distribution function of the output signal:

- GAUSS**
- TRIANGLE**
- EQUIVALENT**

Normal (Gaussian) distribution which is cut off at triple the  $\sigma$ -value of the Gaussian distribution curve.

Triangle distribution from -peak to +peak.

Equivalent distribution from -peak to +peak.

**Note:** *The Gaussian and triangle distributions are obtained by calculation on the basis of equivalent distribution.*

**Ampl Var**

Selection of type of modulation; see 2.5.4.1.4

- OFF**
- SINE**
- BURST**

The amplitude modulation is switched off, the generator signal is not modulated.

The generator signal is amplitude-modulated from 0% to 100% in the form of a sinewave.

The generator signal is switched on and off periodically.

**Mod Freq**

with "Ampl Var SINE", only: setting of the modulation frequency; see 2.5.4.1.4

**Variation**

with "Ampl Var SINE": setting of the variation in %, see 2.5.4.1.4.

**ON TIME**

with "Ampl Var BURST", only: entry of the burst duration , see 2.5.4.1.4.

**INTERVAL**

with "Ampl Var BURST", only: entry of the burst-interval length (burst period) , see 2.5.4.1.4.

### 2.5.4.10 Arbitrary (User-Programmable Signal)

Outputs a user-defined waveform. Five formats with different origins and lengths are supported:

1. **TTF format:** ASCII file with a maximum of 16384 samples. The individual samples are entered as a sequence of numbers (FLOAT format). For the output, the maximum value is equivalent to the peak voltage specified in the VOLTAGE PEAK field, while the other samples are levelled relative to the maximum. The file must contain a line with the keyword `TIMETAB_FILE` before the numbers. Comment lines begin with '#' and can be placed anywhere. No distinction is made between upper-case and lower-case letters. The recommended and preset file extension is '.TTF' (= time table file).
2. **AWD format:** Output file of arbitrary waveform designer. It may contain a maximum of 16384 samples. The recommended and preset file extension is .AWD.
3. **WAV format:** Supports 8-bit and 16-bit formats; 16-bit format requires models 06 or 66 (Pentium CPU). WAV is a standardized waveform format that is widely used in the PC world (sound cards). WAV files may be stored at any sampling rate. However, for use in UPL it should match the selected sampling rate (48 kHz only for analog). If necessary, the WAV file can also be converted to 48 kHz - which is supported by analog and digital applications - by means of a suitable sound-card tool. WAV files of any length are accepted, so they are not restricted to 16384 samples. To load and display large WAV files in 16-bit format, the RAM needs to be extended to enhance performance.

**Option UPL-B29:** *WAV files can be loaded in the base rate mode only.*

4. **CPR format:** This is a special compressed waveform format which accepts any word width up to 16 bits and can therefore be adapted to the performance of a 486-based UPL. A tool is available for generating CPR files by compressing WAV, TTF and AWD files to the required word width (13 bits as standard, 4 to 16 bits can be selected). It is recommended to extend the RAM when working with CPR files.

**Option UPL-B29:** *CPR files can be loaded in the base rate mode only.*

5. **ACC format:** This is a special, compressed waveform format for WAV files containing AC3 or MPEG data coded in line with IEC 61937. A tool is available for generating ACC files by compressing specially coded WAV files such that the output of stereo signals is possible. It is recommended to extend the RAM when working with ACC files. ACC files can only be output in the digital generator.

**Option UPL-B29:** *ACC files can be loaded in the base rate mode only.*

#### Notes:

*Arbitrary waveform designers are software packages for the generation of all types of waveforms, which run on AT-compatible PCs (as on UPL, for example).*

- *The samples are output at the selected sampling rate. If the file was generated for a different sampling rate, the output frequencies are changed accordingly.*
- *The entered waveform is continuously output (no gaps), independent of the actual number of samples. The number of samples is determined by the number of waveform points in the file.*
- *The samples in the WAV, ACC and CPR files are sent online from the hard disk or the extended memory to the DSP generator. A buffer of approx. 2 s is used in the process. If PC capacity is simultaneously used for other tasks, eg the user interface, the buffer may get emptied. In this case the generator will be muted, the buffer refilled and file is output from the start.*
- *If the RAM capacity for outputting the WAV, ACC or CPR files is insufficient, the file must be read directly from the hard disk, which results in a slower transfer between CPU and DSP. As a result, the generator will be more frequently switched-off (muted) and restarted. This can be remedied by*
  - ⇒ *enhancing the extended memory by means of a RAM expansion*
  - ⇒ *reducing the audio bits with the aid of the COMPRESS program (not for ACC files)*
- *The generator is briefly stopped while loading a new file. The output signal is definitely set to 0 V or 0 FS.*
- *Loading of ACC files is useful and practicable in the digital generator, only*

**DC Offset**

see 2.5.4.1.2 Common Parameters for All Generator Functions

**Filename**

Name of file from which the waveform is to be loaded. All files are listed in the above formats as default. The extensions for WAV, ACC and CPR files are compulsory, while TTF and AWD formats also accept different extensions, as these files also have an internal code.

**Example:** 'r&s\_exam.ttf' in directory C:\UPL\USER.

**VOLT PEAK**

Setting of the peak output level; not for ACC files. *Level setting is not possible with ACC files, since all bits must be transferred unchanged*

VOLT PEAK and VOLT RMS are coupled via the crest factor (which is constant for a specific signal). A change of VOLT PEAK therefore immediately affects the figure for VOLT RMS.

Specified range: 0 to  $V_{\max}$

digital:  $V_{\max} = 1 \text{ FS}$

$V_{\max} = 10 \text{ V}$  (Mode Common)

$V_{\max} = 2,5 \text{ UI}$  (Mode Jitter)

analog:  $V_{\max} = 14,142 \text{ V}$  für UNBAL

$V_{\max} = 28,284 \text{ V}$  für BAL

Units:

digital (audio data or phase mode):

FS | %FS | dBFS | LSBs | bits |  $\Delta\%$  | dBr

digital (jitter mode):

UI | %UI | dBUI | ppm | ns | UIr | dBr

analog and digital common mode:

V | mV |  $\mu\text{V}$  |  $V/V_r$  | dBu | dBV | dBr | dBm |

$\Delta\%V$  |  $\Delta V$  |  $\Delta\text{mV}$  |  $\Delta\mu\text{V}$

**VOLT RMS**

Only for format AWD und TTF; Setting of rms output voltage (in the analog generator only).

VOLT PEAK and VOLT RMS are coupled via the crest factor (which is constant for a specific noise signal). A change of VOLT RMS therefore affects the VOLT PEAK value.

Units: V | mV |  $\mu\text{V}$  |  $V/V_r$  | dBu | dBV | dBr | dBm |

$\Delta\%V$  |  $\Delta V$  |  $\Delta\text{mV}$  |  $\Delta\mu\text{V}$

<b>Ampl Var</b>	Selection of the type of modulation; see 2.5.4.1.4. Amplitude variation cannot be performed with using WAV, ACC or CPR files.
<b>OFF</b>	The amplitude modulation is switched off, the generator signal is not modulated.
<b>SINE</b>	The generator signal is amplitude-modulated in the form of a sinewave from 0% to -100%.
<b>BURST</b>	The generator signal is switched on and off periodically.

<b>Mod Freq</b>	with "Ampl Var SINE" only: setting of the modulation frequency, 2.5.4.1.4
-----------------	---

<b>Variation</b>	with "Ampl Var SINE", only: setting of the variation %, see 2.5.4.1.4.
------------------	--

<b>ON TIME</b>	with "Ampl Var BURST", only: entry of the burst duration , see 2.5.4.1.4.
----------------	---

<b>INTERVAL</b>	with "Ampl Var BURST", only: entry of the burst-interval length (burst period) , see 2.5.4.1.4.
-----------------	---

### 2.5.4.11 POLARITY (Polarity Test Signal)

Specific SINE<sup>2</sup> BURST signal with the following characteristics:

FREQUENCY: sample rate /80 (DIGITAL)  
 1.2 kHz (ANALOG)  
 ON-TIME: 1 cyc  
 INTERVAL: 2 cyc

The amplitude of the signal only can be selected by the user. The signal is not DC-free.

DC Offset

see 2.5.4.1.2 Common Parameters for All Generator Functions

VOLTAGE

Enter the SINE<sup>2</sup> amplitude;

Specified range:

digital: 0 to 1 FS  
 analog: 0 to 10 V<sub>rms</sub> for UNBAL (BNC)  
 0 to 20 V<sub>rms</sub> for BAL (XLR)

**Note:** Voltage limitation of the rms value by means of menu item "Max volt", see 2.5.2 Configuration of the Analog Generator / 2.5.3 Configuration of the Digital Generator

Units:

digital (audio data mode):  
 FS | %FS | dBFS | LSBs | bits | Δ% | dBr  
 analog:  
 V | mV | μV | V<sub>pp</sub> | mV<sub>pp</sub> | μV<sub>pp</sub> | V/V<sub>r</sub> |  
 dBu | dBV | dBr | dBm |  
 Δ%V | ΔV | ΔmV | ΔμV

peak-to-peak amplitude (analog):  $V_{pp} = V_{rms} \times 2 \times \sqrt{2}$ ;

V<sub>rms</sub> is the rms value during pulse time, the level during OFF time is not considered in rms value calculation.

### 2.5.4.12 FSK (Frequency Shift Keying)

This item can only be selected with option UPL-B33 built-in (line measurements to ITU-T O33).

Frequency shift keying generates a sequence of two different sinewave frequencies where each is output for 9 ms (baud rate 110). The data coded in this way can only be defined from option UPL-B33 or UPL-B10.

Frequency #1: 1850 Hz, logic 0

Frequency #2: 1650 Hz, logic 1

Voltage

Level of each frequency



**2.5.4.13 STEREO SINE**

Sine with different signals for the left and right channel. Available only in the digital generator (ADATA or PHASE mode) and with option UPL-B6 installed.

The frequencies of the two channels can differ in phase or frequency.

The level in the two channels can be linked to each other by a fixed factor or be completely different.

<b>Frq Offset</b>	See 2.5.4.1.1 Common Parameters for SINE, DFD, MOD DIST
<b>Dither</b>	See 2.5.4.1.1 Common Parameters for SINE, DFD, MOD DIST
<b>PDF</b>	See 2.5.4.1.1 Common Parameters for SINE, DFD, MOD DIST
<b>DC Offset</b>	See 2.5.4.1.2 Common Parameters for All Generator Functions.
<b>Freq Mode</b>	Determines the type of frequency entry in the left and right channel.
<b>FREQ&amp;PHASE</b>	Left (CH1) and right channel (CH2) have the same frequency but a selectable phase with a fixed delay. The phase delay between the two channels remains constant during frequency sweep.
<b>FREQ CH1&amp;2</b>	The frequency of the left (CH1) and right channel (CH2) can be entered independently of each other. During frequency sweep, the frequency of the left channel is swept while that of the right channel remains unchanged.
<b>Volt Mode</b>	Determines the type of level entry in the left and right channel.
<b>VOLT&amp;RATIO</b>	The levels of the left (CH1) and right channel (CH2) have a fixed offset. The offset remains constant during level sweep.
<b>VOLT CH1&amp;2</b>	The level of the left (CH1) and right channel (CH2) can be entered independently of each other. During level sweep, the level of the left channel is swept, that of the right channel remains unchanged.

**SWEEP CTRL**

See 2.5.4.2 Sweeps

The setting of Freq Mode and Volt Mode decides about the parameter changed during frequency or level sweep.

FREQ&PHASE: the (common) frequency is swept

FREQ CH1&2: the frequency of the left channel (CH1) is swept

VOLT&RATIO: the level of the left channel (CH1) is swept; the offset between the right and left channel remains constant

VOLT CH1&2: the level of the left channel (CH1) is swept; the right channel (CH2) remains constant.

**Frequency**

(Freq Mode FREQ&PHASE only) Entry of common sine frequency for both channels. Can be used as sweep parameter.

Specified range: 2 Hz to  $f_{\max}$   
 $f_{\max}$  depending on generator;  
 See 2.5.1 Selecting the Generator

Resolution: 1 mHz

Units: Hz | kHz |  $\Delta$ Hz |  $\Delta$ kHz | f/fr |  $\Delta$ %Hz | Toct | Oct | Dec

**Freq Ch1**

(Freq Mode FREQ CH1&2 only) Entry of sine frequency of left channel. Can be used as sweep parameter.

Specified range: 2 Hz to  $f_{\max}$   
 $f_{\max}$  depending on generator;  
 See 2.5.1 Selecting the Generator

Resolution: 1 mHz

Units: Hz | kHz |  $\Delta$ Hz |  $\Delta$ kHz | f/fr |  $\Delta$ %Hz | Toct | Oct | Dec

**Freq Ch2**

(Freq Mode FREQ CH1&2 only) Entry of sine frequency of left channel. May be used as sweep parameter.

Specified range: 2 Hz to  $f_{\max}$   
 $f_{\max}$  depending on generator;  
 See 2.5.1 Selecting the Generator

Resolution: 1 mHz

Units: Hz | kHz |  $\Delta$ Hz |  $\Delta$ kHz | f/fr |  $\Delta$ %Hz | Toct | Oct | Dec

**Phase Ch2:1**

(Freq Mode FREQ&PHASE only) Entry of phase delay between right and left channel with the left channel (CH1) as reference channel. During the sweep this phase remains constant and cannot be swept.

Specified range: 0 to 360°  
 Unit: ° or RAD

**Equalizer**

**ON**  
**OFF**

See 2.5.4.1.3 Equalization of SINE, SINE BURST, DFD, MULTISINE, RANDOM

The sine voltage is equalized.

The equalizer is switched on. The menu item 'Equal. file' is activated, ie the indicated file is loaded.

Unaffected output voltage

**Equal. file**

(Equalizer file) only with equalizer → ON

See 2.5.4.1.3 Equalization of SINE, SINE BURST, DFD, MULTISINE, RANDOM.

**Volt Ch1**

Entry of sine amplitude of left channel; may be used as sweep parameter.

Specified range: 0 to 1 FS

**Caution:** Limiting of rms voltage with menu item 'Max Volt' see 2.5.3 Configuration of the Digital Generator.

Units: FS | %FS | dBFS | LSBs | bits | Δ% | dBr

**Volt Ch2**

(Volt Mode VOLT CH1&2 only) Entry of sine amplitude of right channel. Remains constant during sweep.

Specified range: 0 to 1 FS

**Caution:** Limiting of rms voltage with menu item 'Max Volt', see 2.5.3 Configuration of the Digital Generator

Units: FS | %FS | dBFS | LSBs | bits | Δ% | dBr

**Volt Ch2:1**

(Volt Mode VOLT&RATIO only) Entry of level offset between channel 2 (right channel) and channel 1 (left channel) as numeric value.

The level of the right channel is reset upon each entry of 'Volt CH2:1' or 'Volt Ch1' and limited to 1.0 FS or 'Max Volt'.

Specified range: 0.0 to 100 k

Unit: none

## 2.5.4.14 MODULATION (modulated sine)

Setting a modulated sinewave signal. Either FM or AM can be used.

**Mode**

Determines the type of modulation.

**FM**

Frequency modulation; output of a frequency-modulated sinewave signal.

**AM**

Amplitude modulation; output of amplitude-modulated sinewave signal.

**Mod Freq**

Setting the modulation frequency

Specified range: 1  $\mu$ Hz to  $f_{\max}$   
 $f$  depending on generator;  
 See 2.5.1 Selecting the Generator

**Carr Freq**

Setting the carrier frequency

**Deviation**

(with Mode FM) Setting the deviation in %.

Specified range: 0 to 100 %

**Example:** Output frequencies of 3960 Hz to 4040 Hz are obtained with 4 kHz carrier frequency and 1% deviation.

**Mod Depth**

(with Mode AM) Setting of modulation depth in %.

Specified range: 0 to 100 %

**Example:** Output levels of 9.90 V to 10.1 V are obtained at 10 V carrier amplitude and 1% modulation depth.

**Carr Volt**

Setting the carrier amplitude

## 2.5.4.15 DC Voltage

SWEEP CTRL

See 2.5.4.2 Sweeps

Voltage

Entry of DC amplitude; may be used as sweep parameter.

Specified range: digital (audio data mode):

0 to 1 FS

analog: 0 to 5 V for UNBAL (BNC)

0 to 10 V for BAL (XLR)

**Caution:** Limiting of rms voltage with menu item 'Max Volt', see 2.5.2 Configuration of the Analog Generator

Units:

digital (audio data mode):

FS | %FS | dBFS | LSBs | bits |  $\Delta\%$  | dBranalog: V | mV |  $\mu\text{V}$  |  $V_{pp}$  |  $mV_{pp}$  |  $\mu V_{pp}$  |  $V/V_r$  |dBu | dBV | dBr | dBm |  $\Delta\%V$  |  $\Delta V$  |  $\Delta mV$  |  $\Delta \mu V$

### 2.5.4.16 Coded Audio (Coded Audio Signals)

This function allows digitally coded (and compressed) audio signals to IEC 61937 to be output. Basically, all formats coded in the audio window of the AES-EBU data stream (MPEG, AC-3, AAC, DTS) can be played.

The CODED AUDIO function uses a library of several thousand short WAV files generated for the individually offered frequency/level combinations and containing a small number of frames. The WAV files are loaded automatically and played repetitively when a (new) frequency or a (new) level is entered. Since only those frequencies are set whose integer periods fit into such a package, the output signal has no hops. When the frequency or level is changed, switchover to the first frame of the new file is performed without any interruption at the end of the last frame of the old file. This ensures that the DUT does not have to synchronize again. The exact characteristics of the library used depend on the selected format and are explained there.

The user sets a new frequency or a new level in the same way as with a 'normal' sine. The UPL software automatically activates the next suitable frequency/level pair. Frequency and level sweeps can also be set as usual. Since the analyzer is synchronized to the generator and continuous sweep stepping can be synchronized to the analyzer (next step ANLR SYNC), very fast sweeps can be performed.

This function is available only in the digital generator and can be selected only if the two channels are switched on and the UPL-B23 option (Coded Audio Signal Generation) is installed.

Presently, the UPL-B23 only contains the AC-3 digital format (Dolby Digital); other formats are in preparation.

#### Notes:

- *The digital generator is directly connected to the digital input of the (AC-3) decoder. The decoded and D/A-converted output signal is measured with the analog analyzer of the UPL.*
- *For S/N measurements, the noise measurement is not performed using a pause frame but using a very soft signal level (-120 dB). This prevents the DUT from muting.*
- *While this generator function only generates individual (single or multichannel) sounds, the ARBITRARY function of the digital generator also allows any signals (e.g. multisine, noise) of any length to be played. These signals must be generated by the user as coded WAV files and converted into ACC files by means of the COMPRESS program. The ACC files are then output in the generator. User-defined signal sequences can also be played this way. Synchronization of the analyzer is via the external sweep.*

#### Optimization for UPL 06/66 with at least 32 Mbyte RAM:

*If sufficient RAM is available, it is recommended to activate a RAM drive to accelerate downloading from the hard disk. If the UPL-B23 was installed in the service center or ordered when the UPL was purchased, the RAM drive option is already available.*

*If a RAM drive is activated, the WAV files required for signal generation are automatically cached on the RAM drive (if they are used more than once) and can be downloaded extremely quickly from the RAM. If a generator sweep is set and started, for example, the first sweep takes the normal and the following sweeps a far shorter measurement time.*

*To install a RAM drive (see section 1.2.3 Installation of Virtual Drive (RAMDRIVE))*

**Format**

<b>AC-3</b>
-------------

Coding format (presently only AC-3 available); has an effect on the frame length and on the frequency resolution.

A separate library of WAV files is installed for each format. If the format selection is extended, an upgraded UPL-B23 option has to be installed.

Dolby Digital: up to 6 sound channels; can be output either individually, as 5.1 multichannel or as stereo signal. Frequency and level can also be selected. All other parameters for "Audio Service", "Bitstream Information" and "Preprocessing" are invariable default settings.

The AC-3 format is selectable only at a sampling rate of 48 kHz. It contains frames with a length of 1536 samples. Each WAV file contains 1 to 6 frames. The frequency resolution *per frame* is therefore:  
 $48000 \text{ Hz} / 1536 = 31.25 \text{ Hz}$ .

**Notes:**

1. *User-defined AC-3 signals of any length can be played with the ARBITRARY function. The AC-3 sequences have to be available as WAV files and compressed to the UPL-internal ACC format by means of the COMPRESS.EXE utility program.*
2. *When measurements are carried out on AC-3 decoders, their delay has to be taken into account in the analyzer panel. The measurement should be performed with settling switched on to avoid settling problems of the DUT.*

**Chan Mode**

<b>2/0</b>	<b>192 kb/s</b>
<b>5.1</b>	<b>448 kb/s</b>
<b>L</b>	<b>448 kb/s</b>
<b>C</b>	<b>448 kb/s</b>
<b>R</b>	<b>448 kb/s</b>
<b>LS</b>	<b>448 kb/s</b>
<b>RS</b>	<b>448 kb/s</b>
<b>LFE</b>	<b>448 kb/s</b>

(Channel mode) selection of channels producing sound.

Stereo mode at 192 kb/s. Frequency and level variation or sweep is possible. Coding of samples at 24 bits.

Field of application: Frequency response and linearity measurements

Multichannel sound with all channels at 448 kb/s. Frequency and level variation or sweep is possible. Coding of samples at 24 bits.

Field of application: Frequency response and linearity measurements

Single channels at 448 kb/s. Limited frequency selection, fixed level (-20 dB). Coding of samples at 16 bits.

Field of application: crosstalk measurement.

L: front left; C: (front) center; R: front right;

LS: rear left; RS: rear right;

LFE: low frequency enhancement.

**Frequency**

<b>42</b>	<b>Hz</b>
<b>997</b>	<b>Hz</b>
<b>15</b>	<b>kHz</b>

Fixed frequency selection for crosstalk measurements and linearity (level) sweeps. Displayed only in single channel modes or when level variation is selected.

Exactly 41.7 Hz

Exactly 994.8 Hz

Exactly 15000.0 Hz



**SWEEP CTRL**

See 2.5.4.2 Sweeps

**Vari Mode**

(Variation mode) determines which parameter can be varied or swept. Displayed only in multichannel modes (2/0 or 5.1).

**VOLTAGE**

Level can be varied in 24 steps of -5 dBFS between 0 dBFS and -120 dBFS. One of 3 fixed settings can be selected as frequency. Field of application: Linearity measurements

**FREQUENCY**

Frequency can be varied. The level is at -20 dB. Field of application: Frequency response measurements

**Notes:**

1. When the sweep is switched on (SWEEP CTRL), the selected variation mode is taken as the X axis. When the sweep is switched off (SWEEP CTRL OFF), the X axis is taken as the variation mode.
2. A level sweep over more than 25 points is useless since only a maximum of 25 different levels can be set.

<b>FREQUENCY</b>
------------------

Entry of sine frequency; may be used as sweep parameter. Displayed only in multichannel modes (2/0 or 5.1) with frequency variation selected. As described under "Format", the frequency resolution per frame is 31.25 Hz. The more frames are coded, the finer the frequency resolution is. The frequency resolution required determines the number of frames and the maximum length of the WAV files. The longer the WAV files, the longer the download times and the total measurement time. To offer a compromise between frequency resolution and measurement speed, the length of the WAV files is limited to 6 frames. This corresponds to a frequency resolution of 5.21 Hz.

This high frequency resolution is required only for low frequencies since a logarithmic frequency division is normally performed for frequency response sweeps. To avoid obtaining too many frequency values (and WAV files) the frequency resolution towards higher frequencies is limited so that fewer frames are required for coding. This increases the measurement speed at higher frequencies.

Frequency range:	5 Hz to 1 kHz	1 kHz to 3 kHz	3 kHz to 20 kHz
Resolution:	5.21 Hz	10.42 Hz	31.25 Hz
Number of frames:	1 to 6	1 to 3	1

Value range: 5.21 Hz to 20 kHz (sampling rate only 48 kHz)

Units: Hz | kHz | ΔHz | ΔkHz | f/fr | Δ%Hz | Toct | Oct | Dec

**Notes:**

1. To further increase the measurement speed during sweeps, as many frequency points as possible should be an integer multiple of 31.25 Hz for frequencies below 3 kHz. This can be implemented by a list sweep.
2. The RMS measurement time GEN TRACK does not provide the usual high-precision results with Coded Audio since the generator frequency cannot be synchronized to the exact measurement time. It is therefore recommended to use the measurement time AUTO or AUTO FAST.

<b>VOLTAGE</b>
----------------

Entry of sine amplitude; may be used as sweep parameter. Displayed only in multichannel modes (2/0 or 5.1) with level variation selected.

The level can be varied in 24 steps of -5 dBFS between 0 dBFS and -120 dBFS.

Value range (only digital, audio data mode):  
-120 dBFS to 0 dBFS

Units (only digital, audio data mode):  
FS | %FS | dBFS | LSBs | bits | Δ% | dBr

**2.5.5 Auxiliary Generator**

With option UPL-B1 (low-distortion generator) fitted, an additional sinewave generator is available for producing analog or noise signals up to 110 kHz in the source mode AUDIO DATA or PHASE. Thus,

- *digital* audio data of any signal shape and an *analog* sinewave signal or
- *digital* audio data of any signal shape and a *superimposed* noise signal (jitter or common mode signal)

can be generated *simultaneously*.

The auxiliary generator has the same specifications as the low-distortion generator and its own (1-dimensional) sweep system for sweeping either the level or frequency.

<b>AUX GEN</b>	Activation of auxiliary generator and selection of use.
<b>OFF</b>	Auxiliary generator switched off; audio data are generated without a noise signal, analog outputs switched off (high-impedance).
<b>ANALOG OUT</b>	Audio data are generated without a noise signal. In addition to the digital signal (at the BAL, UNBAL and optical outputs) an analog signal is generated at the analog XLR connector. Frequency and level of the analog signal can be set or swept.
<b>COMMON MODE</b>	A common mode signal is superimposed onto the audio data, the analog outputs are switched off (high-impedance). Frequency and level of the noise signal can be set or swept.
<b>JITTER</b>	A jitter signal is added to the audio data, the analog outputs are switched off (high-impedance). Jitter frequency and level can be set or swept.

### 2.5.5.1 Auxiliary Generator Used as Analog Generator

The generator can be used as a balanced or unbalanced source with one or two output channels. Different source impedances can be selected. The low-distortion generator is used, level control is via the output amplifier.

Channel(s)	Description
OFF	Both channels off
1	Channel 1 on, channel 2 off
2	Channel 2 on, channel 1 off
2 $\equiv$ 1	Same signal on both channels

Output	Description
UNBAL	XLR connectors can be used as balanced (BAL) or unbalanced (UNBAL) output. An unbalanced signal is generated at the XLR connector; The maximum output level is 10 V.
BAL	A balanced signal is generated at the XLR connector; the maximum output level is 20 V. The output impedance can be selected in three steps.

Impedance	Description
10 $\Omega$ 200 $\Omega$ 600 $\Omega$	Selection of output impedance, with BAL selected; the output impedance of the unbalanced output is 5 $\Omega$ .

Anlg Freq	Description
	Entry of sinewave frequency of analog signal Specified range: 2 Hz to 110 kHz Units: Hz   kHz   $\Delta$ Hz   $\Delta$ kHz   f/fr   $\Delta$ %Hz   Toct   Oct   Dec

Anlg Ampl	Description
	Entry of sinewave amplitude of analog signal Specified range: 0 to 10 $V_{rms}$ for UNBAL 0 to 20 $V_{rms}$ for BAL Units: V   mV   $\mu$ V   $V_{pp}$   $mV_{pp}$   $\mu V_{pp}$   dBu   dBV   dBm Peak-to-peak amplitude: $V_{ss} = V_{rms} \times 2 \times \sqrt{2}$

### 2.5.5.2 Auxiliary Generator Used as Common Mode Generator

The auxiliary generator superimposes a common-mode sinewave signal on the digital output signal.

**Note:** *This common mode signal can also be generated by the function generator in the source mode COMMON ONLY. Signal shapes other than sinusoidal are possible for the noise signal (e.g. noise), but the audio data cannot be set.*

#### Comm Freq

Entry of common mode frequency

Specified range: 2 Hz to 110 kHz

Units: Hz | kHz | ΔHz | ΔkHz | f/fr | Δ%Hz | Toct | Oct | Dec

#### Comm Ampl

Entry of common mode amplitude

Specified range: 0 to 7.071 V<sub>rms</sub>

Units: V | mV | μV | V<sub>pp</sub> | mV<sub>pp</sub> | μV<sub>pp</sub> | dBu | dBV | dBm

Peak-to-peak amplitude:  $V_{pp} = V_{rms} \times 2 \times \sqrt{2}$

### 2.5.5.3 Auxiliary Generator Used as Jitter Generator

The auxiliary generator superimposes a sinewave jitter signal on the digital output signal.

**Note:** *This jitter signal can also be generated by the function generator in the source mode JITTER ONLY. Signal shapes other than sinusoidal are also possible for the jitter signal (e.g. noise), but the audio data cannot be set.*

#### Jitt Freq

Entry of jitter frequency

Specified range: 2 Hz to 110 kHz

Units: Hz | kHz | ΔHz | ΔkHz | f/fr | Δ%Hz | Toct | Oct | Dec

#### JittPkAmpl

Entry of jitter peak amplitude

Specified range: 0 to 0,25 UI

Units: UI | %UI | dBUI | ppm | ns

**Note:** *For all applications for which the jitter peak amplitude of the auxiliary generator is not sufficient, the jitter signal can also be generated by the function generator in the source mode JITTER ONLY. Setting audio data is not possible in this case.*

### 2.5.5.4 Auxiliary Generator Sweep

The sweep system of the auxiliary generator is similar to that of the function generator (see 2.5.4.2 Sweeps). A 2-dimensional sweep, i.e. simultaneous sweep of frequency and level, is not implemented.

**SWEEP CTRL**

see 2.5.4.2 Sweeps

**FREQ FILE**

Entry of a file name for the frequency list (list sweep).

For entering file names see 2.3.2 Data Entry

**VOLT FILE**

Entry of a file name for the amplitude list (list sweep).

For entering file names see 2.3.2 Data Entry

## 2.6 Analyzers (ANALYZER Panel)

### Activate the ANALYZER panel:

UPL front panel: ANLR key

External keyboard: ALT + A

Mouse: (repeated) click on the panel name, until the ANALYZER panel is displayed

If the ANALYZER panel is already visible on the screen, it can be activated also by actuating one of the TAB keys (repeatedly) or by mouse-click.

Advantage: The panel need not be established again.

### 2.6.1 Selecting the Analyzer

The ANALYZER panel makes the settings for 2 analog and 1 digital analyzer instrument available.

The ANALYZER panel consists of the following segments:

ANALYZER			
ANALYZER	ANLG 22k Hz	↑ Configurations	Selection of the analog or digital instrument, reference impedance for power units, configuration segment for setting the test inputs.
:	:		
CHANNEL(s)	2 ≡ 1	↑ Configurations	(Input connectors, channel selection, input impedance) see 2.6.3 Configuration of the Digital Analyzer see 2.6.2 Configuration of the Analog Analyzers
:	:		
START COND	AUTO	↑ Higher-level functions	Ways of starting the analyzer, see 2.6.4
:	:		
INPUT DISP	ON	↑ Higher-level functions	Input signal, see 2.6.5.18 INPUT
:	:		
FREQ/PHASE	FREQ & PHASE	↑ Higher-level functions	Combined frequency / phase measurement, see 2.6.5.19
:	:		
FUNCTION	RMS & S/N	↑ Functions	Analyzer functions, see 2.6.5.2 to 2.6.5.19
:	:	↓ Functions	

When switching from the analyzer instrument to the other, the data of all segments are stored for the current instrument, the data of the new instrument are loaded and the panel contents can be entered anew. When changing to the analyzer function, the settings in the configuration range are retained.

**Note:** The “parameter link” function which can be selected in the OPTION panel may be used to influence the UPL with changes of function and instrument. As requested, existing settings in the function and/or configuration segment of the GENERATOR panel are accepted for the new function or instrument - if physically possible.

**.-Measurement range limits of the ANALYZER instruments:**

Table 2-27

Instrument	Lower limit	Upper limit	Sample rate
ANLG 22 kHz <sup>1)</sup>	DC/10 Hz	21.9 kHz	48 kHz
ANLG 110 kHz <sup>1)</sup>	DC/20 Hz	110 kHz	307.2 kHz
DIGITAL with UPL-B2	10 Hz	2)	27 ... 55 kHz
DIGITAL with UPL-B29	10 Hz	2)	35 ... 106 kHz

1) The frequency value refers to the upper limit of the analog analyzers

2) Limit depends on sampling rate (see below)

**Lower limit:**

DC: Setting the DC function in one of the two analog analyzer instruments results in DC coupling of the input unit

10 Hz: The menu item "Min Freq" in the analyzer instruments ANLG 22 kHz and DIGITAL indicates the lower limit.

20 Hz: The menu item "Min Freq" in the "fast" analyzer instruments (ANLG 110 kHz) indicates the lower limit.

**Upper limit:**

Signals can be measured up to this limit.

**Measurement range limits of the digital ANALYZER instrument:**

The maximum measurement frequency is given by

$$f_{max} = \text{sample frequency} \times 0.5 \text{ for RMS, otherwise sample frequency} \times 117 / 256$$

Set the sample frequency in the configuration segment of the ANALYZER panel using menu item Sample-Frq.

For more details, refer to 2.6.3 Configuration of the Digital Analyzer.



Table 2-28 Availability of functions depending on the ANALYZER instrument:

Instrument	Measurement functions																
	RMS	RMS sel	PEAK	QPEAK	DC	THD	THD+N	MOD DIST	DFD	Wow &FL	FFT	Polarity	Filter-Sim	Coher	Rub& Buzz	1/3-Octave	Wave-form
ANLG 22 kHz	yes	yes	yes	yes	yes	yes	yes	yes	yes	yes	yes	yes	yes	yes	yes <sup>1)</sup>	yes	yes
ANLG 110 kHz	yes	yes	-	-	yes	yes	yes	yes	yes	-	yes	yes	yes	-	yes <sup>1)</sup>	-	yes
DIGITAL	yes	yes	yes	yes	yes	yes	yes	yes	yes	yes	yes	yes	yes	yes	-	yes <sup>1)</sup>	yes

<sup>1)</sup> with built-in option UPL-B29 (digital audio 96 kHz) in the base rate mode only

**Higher-level functions:**

The selected function can be complemented by higher-level supplementary functions.

**INPUT-DISP measurement:**

see 2.6.5.18

- PEAK Display of the peak value of the two input signals
- RMS Display of the rms value for the measurement functions THD, THD+N, FFT, MOD DIST and DFD
- PHAS TO REF (with Jitter option UPL-B22 only in the analyzer mode JITTER/PHAS)  
Display of phase between selected digital input and reference input
- DIG INP AMP (with Jitter option UPL-B22 only in the analyzer mode COMMON/INP)  
Display digital signal amplitude

If INPUT DISP RMS is set and a measurement function is selected which does not allow for RMS display or where it does not make sense, "-----" is displayed in the Input RMS window. INPUT PEAK measurements can still be performed.

The availability of the INPUT RMS measurement related to the selected measurement function can be looked up in the subsequent table.

**Frequency and phase measurement**

see 2.6.5.19

- FREQuency display on all channels switched on

Additionally, in the analyzers ANLG 22 kHz and DIGITAL

- FREQuency display on channel 1, PHASE display on channel 2; selectable only with two-channel measurement
- FREQuency display on channel 1, GRPDEL group delay) display on channel 2, selectable only with two-channel measurement

Additionally, in the analyzer DIGITAL

- SAMPLE FREQuency display on all channels switched on

If a measurement function has been selected which does not allow frequency or phase measurement or where it does not make sense (such as DFD), "-----" is displayed in the "Freq & Phase" window. Refer to the table below for the availability of the frequency and phase measurement in dependence of the selected measurement function.

Table 2-29 Availability of frequency and phase measurement depending on measurement functions

Measurement function	INPUT DISP		FREQ/PHASE		
	PEAK	RMS	FREQ	PHASE	GRP DELAY
OFF	yes	yes	yes	ANLG 22kHz/DIGITAL	ANLG 22kHz/DIGITAL
RMS & S/N	yes	ANLG 110 kHz	yes	ANLG 22kHz/DIGITAL <sup>3)</sup>	ANLG 22kHz/DIGITAL <sup>3)</sup>
RMS select	yes	yes	yes	no	no
PEAK & S/N	yes	no	no	no	no
Q PK & S/N	yes	no	no	no	no
DC	yes	no	no	no	no
THD	yes	yes	yes	no	no
THD+N	yes	yes	yes	ANLG 22kHz/DIGITAL2)	ANLG 22kHz/DIGITAL2)
MOD DIST	yes	yes	no <sup>1)</sup>	no	no
DFD	yes	yes	no <sup>1)</sup>	no	no
WOW & FL	yes	no	no	no	no
POLARITY	yes	no	no	no	no
FFT	yes	yes	yes	ANLG 22kHz/DIGITAL	ANLG 22kHz/DIGITAL
FILTSIM	no	no	no	no	no
WAVEFORM	yes	no	no	no	no
Coherence	yes	no	no	no	no
1/3-OCTAVE	yes	no	no	no	no
Rub & Buzz	yes	ANLG 110 kHz	yes	no	no

1) However, the individual frequencies of signal and interference are displayed in a histogram or spectrum list.

2) with built-in option UPL-B29 (digital audio 96 kHz) in the base rate mode only

3) with built-in option UPL-B29 (digital audio 96 kHz) in the base rate mode only; in the high rate mode with filter switched off and 'Meas Time' GEN TRACK or VALUE.

### 2.6.2 Configuration of Analog Analyzers

The two-channel analog analyzer features balanced XLR test inputs; unbalanced BNC cables can be connected via an *adapter* plug UPL-Z1 which can be supplied separately. Both channels can be configured individually. The configuration is explained by way of the below ANALYZER panel and its menu items.

<p><b>Min Freq</b></p>	<p>Display of the lower frequency range limit.</p>
<p>10 Hz</p> <p>20 Hz</p>	<p>lower limit frequency 10 Hz with ANLG 22 kHz</p>
	<p>lower limit frequency 20 Hz with ANLG 110 kHz</p>
<p><b>Ref Imped</b></p>	<p>(Reference Impedance)</p> <p>Reference impedance as reference for computing the units dBm, W, Δ%W, ΔW, P/Pr and %P/Pr (see <b>2.4 Units</b>).</p> <p>Specified range: 1 mΩ to 100 kΩ</p>
<p><b>Channel(s)</b></p>	<p>Select the input channels.</p>
<p>1</p> <p>2</p> <p>1 &amp; 2</p> <p>2 ≡ 1</p> <p>1 ≡ 2</p>	<p>The selected channel only is active, the other one is switched off.</p> <p>The input impedance is retained at the XLR female connectors when the channel is switched off (see "Input" BAL XLR, "Impedance").</p> <p>Both channels are active and can be configured individually.</p> <p>Both channels are active and equally configured. When <i>switching over</i> to this selection causes channel 2 to be set using the parameters of channel 1.</p> <p>Both channels are active and equally configured. When <i>switching over</i> to this selection causes channel 1 to be set using the parameters of channel 2.</p>

Coupling	
AC	<p>Selection of input coupling. AC or DC coupling may be selected to make use of the full frequency range of the UPL (DC to 22/110 kHz) and to suppress the undesired DC of the DUT. This selection can be made (with setting "1&amp;2") independently for both channels.</p> <p>AC coupling: a DC offset of the DUT will not be transmitted and does not therefore affect the DUT. The specifications of the UPL analyzer are with reference to this type of coupling.</p> <p>When the DC measurement function is selected, the setting "AC coupling" is ignored, i.e. the measurement is always performed with DC coupling. The input impedances with 300 <math>\Omega</math> and 600 <math>\Omega</math> are generally DC-coupled (see Impedance).</p> <p><b>Note:</b> <i>A procedure similar to AC coupling can be selected in the digital analyzer for specific measurement functions. Selection is made with menu item "DC Suppress ON" under the specific measurement function.</i></p>
DC	<p>DC coupling: test signals up to 0 Hz are picked up and considered in the results of RMS, RMS selective, peak, quasi peak, DC, FFT and waveform measurements.</p> <p><b>Note:</b> <i>Irrespective of the selection made here, "Min Freq" is used as the limit frequency for automatic algorithms (e.g. "Range AUTO", "Meas Time AUTO"). Signals below the specified "Min Freq" can be detected but not reliably interpreted with these automatic functions. In the event that very low-frequency signals are to be measured (with DC coupling), it is recommended to use the settings FIX or VALUE.</i></p>

<b>Input</b>	Select the input mode.
<b>BAL</b>	<p>The current setting is displayed. (See also 2.12 Display of Selected Inputs / Outputs). The input mode can be reset after having opened the selection window.</p> <p><b>Balanced to ground test inputs via XLR female connectors (see Fig. 2-18). Deactivated inputs are floating, set input impedances 300 Ω or 600 Ω are retained.</b></p> <p>Unbalanced measurements can be performed via BNC/XLR <i>adapter</i> (UPL-Z1 option).</p>
<b>GEN1 GEN2 GEN CROSSED</b>	<p>Internal connection of the analyzer input or both analyzer inputs to the generator output of the other channel, respectively. Allows the device-internal measurement of the voltages at the generator connectors as well as crosstalk and two-port measurements. The generator output is loaded by each analyzer channel by 2 x 100 kΩ (see Figures 2-17, 2-18 and 2-19). The input connectors (female) of the appertaining analyzer channels are inactive.</p>

**Note:** *If both channels are configured equally (channels 2≐1 or 1≐2), GEN CROSSED is displayed instead of GEN CH1 or GEN CH2. Physically, this conjunction is identical.*

<b>Impedance</b>	Select the input impedance, only selectable in BAL mode.
<b>300 Ω</b>	Impedance 300 Ω, input impedance is DC-coupled.
<b>600 Ω</b>	Impedance 600 Ω, input impedance is DC-coupled.
<b>200 kΩ</b>	Impedance 200 kΩ

With impedances 300 Ω and 600 Ω, only voltages of up to 25 V may be applied. With voltages > 25 V the input is protected against overloading. The input impedance is temporarily switched to 200 kΩ and the generator output switched off, see 2.13 Fast Switch-off of Outputs. The overload protection of the analyzer inputs is valid for analog board versions ≥ 4.00 and software version ≥ 1.0.

<b>Common</b>	Common reference of potential of the XLR inputs, selectable in the BAL mode only.
<b>FLOAT</b>	<p>XLR pin floating against chassis ground.</p> <p>Permissible voltage ≤ 30 V AC or 50 V DC against chassis ground.</p>
<b>GROUND</b>	<p>XLR pin 1 connected to frame ground (PE conductor).</p> <p>Switchover to GEN mode at a later date or switching off the set balanced channel renders the reference to ground ineffective.</p>



Table 2-30 Voltage measurement ranges of analog analyzers

Measurement range  (Nominal value)	Measurement function		Remarks
	DC	Others	
18 mV	1)	yes	Ranges 60.0 V and 100.0 V are available for analog board versions $\geq$ 4.00 and software versions $\geq$ 1.0.
30 mV	1)	yes	
60 mV	1)	yes	
100 mV	yes	yes	
180 mV	1)	yes	
300 mV	yes	yes	
600 mV	1)	yes	
1.0 V	yes	yes	
1.8 V	1)	yes	
3.0 V	yes	yes	
6.0 V	1)	yes	
10.0 V	yes	yes	
18.0 V	1)	yes	
30.0 V	yes	yes	
60.0 V	1)	yes	
100.0V	yes	yes	

1) With the DC function, the next insensitive and valid range is internally set when selecting the range. (see 2.6.5.5 DC)

An optimum dynamic range for the measurement of non-linear distortions is guaranteed by spacing the range in 5-dB steps. Overranges or underranges in the current measurement range causes the switchover to the next possible range provided that RANGE AUTO is selected. The same is true for RANGE LOWER, however switchover to the next lower range is performed only when the range limit selected in the menu is not violated.

The range values are rms values for sine or other waveforms with a crest factor of  $\sqrt{2}$  or less.

Equivalent circuit diagrams of test inputs:

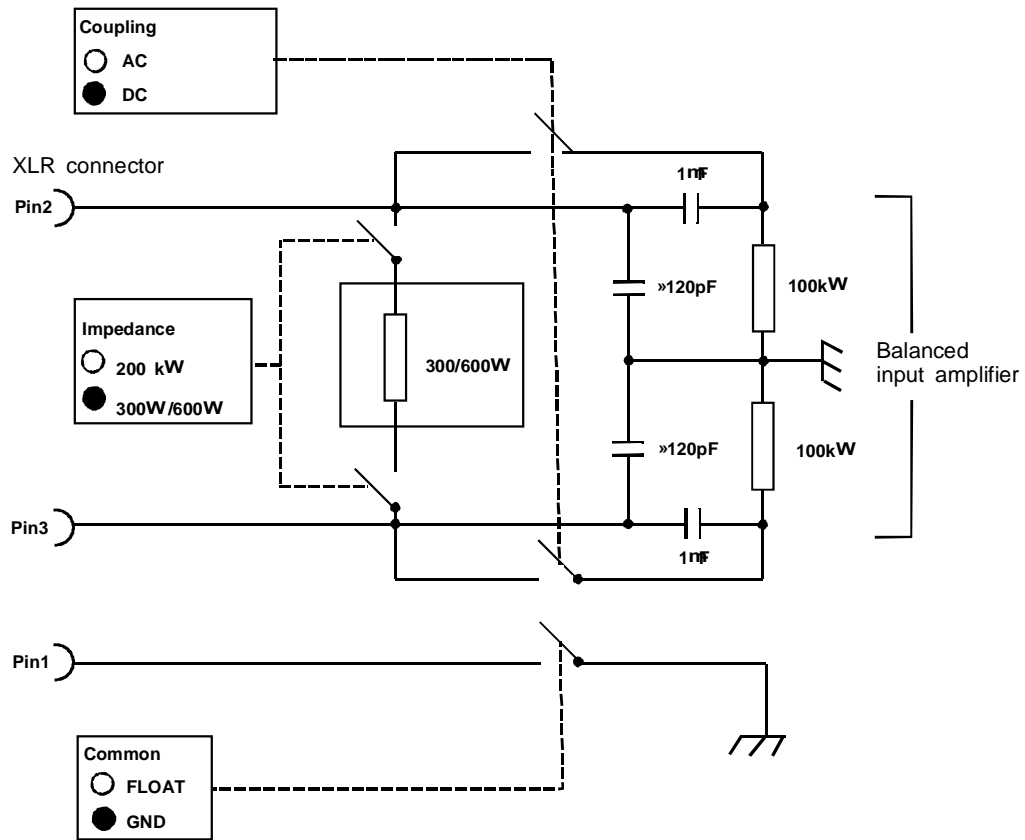

Fig. 2-16 Balanced input (Input BAL, channel 1 or 2)

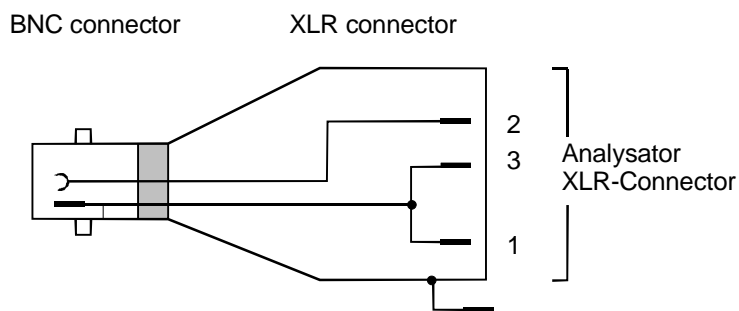

Fig. 2-17 Unbalanced measurement via BNC/XLR adapter



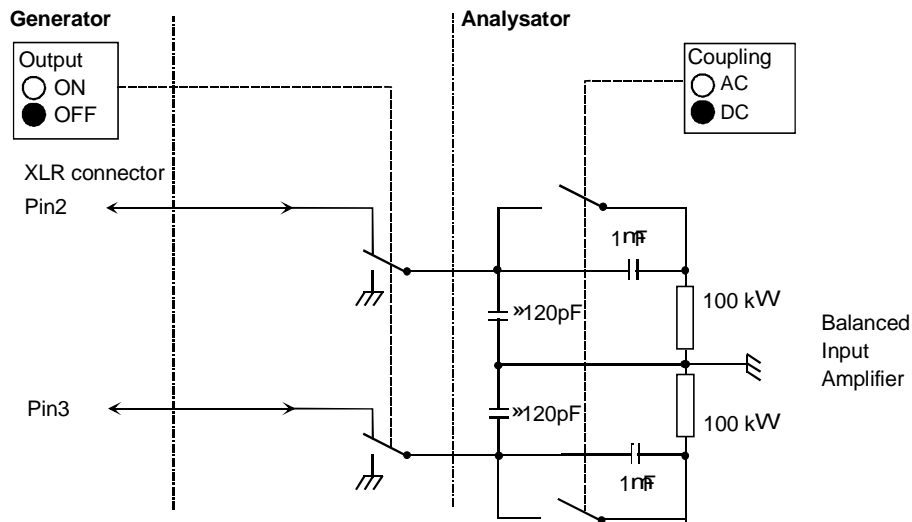

Fig. 2-18 Internal connection to generator output

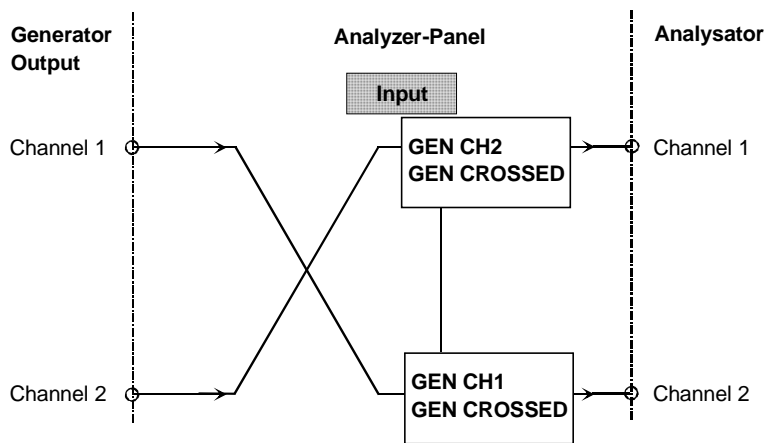

Fig. 2-19 Internal signal paths

### 2.6.3 Configuration of Digital Analyzer

#### Notes:

- Prior to making the analyzer settings, the generator should be configured usefully. Otherwise, undesired generator settings could cause superfluous restrictions in the analyzer panel.
- If the generator is not used as a signal source, it is advisable to switch over to analog mode in order to avoid any interference of the generator settings.

<b>Meas Mode</b>	(measurement mode) indicates what is to be measured at the digital interfaces.
<b>AUDIO DATA</b>	Measurement of digital audio data
<b>JITTER/PHAS</b>	Measurement of jitter at the selected digital audio input and of the phase offset to the reference signal (REF IN at the rear of the instrument).
<b>COMMON/INP</b>	Measurement of COMMON signal (at XLR female connector) and digital input amplitude.

**Note:** A COMMON measurement is not possible at the unbalanced digital input (BNC connector). Therefore, irrespective of the selected input, the COMMON MODE measurement is always performed at the balanced input (CLR connector). Consequently, selection of the digital input only affects the measurements of DIG INP AMP and SAMPLE FREQ.

**Note:** Functions producing a level measurement result are the only appropriate with Jitter/Phas Common/Inp modes which is why function selection is restricted to the level measurements (RMS and PEAK) as well as the FFT and waveform display. With FFT selected, RMS values are displayed.

<b>Min Freq</b>	Is displayed only if AUDIO DATA has been selected as Meas Mode.
<b>10 Hz</b>	Display of the lower frequency range limit for measurement of the digital audio data.

<b>Channel(s)</b>	Is displayed only if AUDIO DATA has been selected for Meas Mode. All other analyzer modes refer to the digital data <i>stream</i> and not to the data <i>content</i> so that specifying a channel would be meaningless.
<b>1</b>	Measurement on channel 1, only; data of channel 2 are ignored.
<b>2</b>	Measurement on channel 2, only; data of channel 1 are ignored.
<b>BOTH</b>	Measurement on both channels





Sync To

AUDIO IN  
REF IN

(Analyzer synchronized to)

*Is displayed only, if AUDIO DATA has been selected for Meas Mode; with JITTER/PHASE, fixed settings are obtained (depending on "Jitter Ref" and the synchronization of the generator).*

Indicates the input signal to which the analyzer is synchronized.

Synchronization to the digital AUDIO input signal (front panel).

Synchronization to the REF IN input signal (XLR female on the rear panel).

**Note:** *In Meas Mode JITTER/PHAS the analyzer automatically synchronizes to the clock selected as "Jitter Ref"*

**Sample Freq**

32 kHz  
 44.1 kHz  
 48 kHz  
 88.2 kHz  
 96 kHz

VALUE:

AUTO

CHAN STATUS

Is displayed only if AUDIO DATA has been selected as Meas Mode.

Setting the signal clock rate.

The clock rate can be selected as desired only, if the analyzer does not synchronize to the generator clock, otherwise - if in the JITTER/PHAS Meas Mode the generator has been selected as Jitter Ref - Sample Freq is automatically set (invisible to the user) to the generator clock rate.

with option UPL-B2 (digital audio I/O) only

only with option UPL-B29 (digital audio 96 kHz) in the high rate mode

only with option UPL-B29 (digital audio 96 kHz) in the high rate mode

Range for numerical input:

- with option UPL-B2 (digital audio I/O) 27 kHz to 55 kHz
- with option UPL-B29 in the base rate mode 35 kHz to 55 kHz
- with option UPL-B29 in the high rate mode 35 kHz to 106 kHz

The analyzer is informed on the sample frequency *applied* by means of the (numerical or predefined) selection of the sample frequency in order to enable correct measurement of the audio signal frequencies. This information does not influence the synchronization of the analyzer.

For Sample Freq, the actually measured sampling rate is entered. The sampling rate is updated once per second provided it has changed by at least 0.01 %.

If no signal (clock) is applied, the previous sampling rate is retained in the panel until a clock is applied again. No measurement can be performed then; all measured-value displays indicate "Input? – press show I/O"

For determining the sample rate the corresponding channel status bits in the AES/IBU protocol of the test signal are decoded. Depending on the format (consumer or professional) different bits are interpreted (24 to 27 or 6 to 7 and 35 to 38). The sample rate is updated as soon as a different sample rate is indicated by the channel status bits.

If the channel status bits do not forward any information ("not indicated"), or if protocol analysis is switched off, the most recently set sampling rate remains active.

**Note:** *If the frequency entered does not correspond to the frequency applied, all filter and frequency measurements vary accordingly in frequency! The frequency applied to the UPL (sample rate) must not exceed 55 kHz (UPL-B2) and 106 kHz (UPL-B29). Otherwise, incorrect measurements or abortion of the measurement may occur.*

The maximum measurement frequency of the digital analyzer is obtained from the sample frequency and the (modified) "Nyquist" factor:

$$f_{\max} = \text{sample rate} \times 117 / 256$$

**Audio Bits**

8 to 24

Reducing the word length causes the audio sample values to be cut to the specified word length.

### **2.6.3.1 Measurement of Jitter, Phase and Common Mode**

With digital audio interfaces, there are two types of signals to be measured, e.g., within a quality check. One is the digitally coded analog signal, and the other the digital signal. The latter too has analog parameters such as peak-to-peak voltage, frequency etc. It may be subject to interference like an analog signal. Noise or AC voltage may be superimposed, which may cause the signal slopes to be shifted. This effect is called jitter and, if it is strong enough, the audio signal can no longer be decoded or regenerated correctly. The conventional decoders fail often even before reaching the theoretical limit which is why information on the practically reached jitter in a facility is quite important.

The signal lines can be designed as balanced lines which is quite usual in analog technology. Thus, injected interferences, e.g. from grounded (hum) loops would be ineffective. However, in practice, this attenuation is not always sufficient so that a common-mode voltage of sufficiently high magnitude may also prevent decoding and regeneration. The UPL can measure this common-mode voltage on the digital signal. Of course, a common-mode signal cannot be generated at the unbalanced and the optical output.

The UPL can thus measure two different types of interference of the digital audio signals: shifting of the signal slopes (jitter) and a common-mode voltage superimposed on the digital lines. The analog generator is available for measurement of the interference voltages. The RMS (&S/N) and peak functions as well as the FFT analysis and the oscilloscope display (WAVEFORM) are particularly suited for the practice. The spectrum analysis allows first conclusions to be made on the cause of the interference (e.g., superimposed AC hum or switching power supply). The interference caused by the common-mode voltage can be read off directly as voltage.

Jitter and delay are usually stated in UI (unit interval). UI is defined as the smallest pulse width of the digital audio signal (eye width) and is independent of the selected sample frequency. One UI corresponds to the clock period of the digital signal (biphase clock). With digital audio signals, one UI corresponds to the 128th of the sample period; at 48 kHz one UI is approx. 163 ns.

For measuring the jitter, a reference clock must be available. For this purpose a high-stability internal oscillator can be used or a PLL (phase locked loop), if the UPL is externally synchronized (via the "Sync In" connector on the rear panel). The PLL integrates phase deviations as a function of time. Both the internal oscillator and the PLL are also used for the digital generator, so that analyzer and generator cannot be set completely independent of each other in this case.

If several, digitally-coded signals have to be interconnected, as commonly done in the studio, the signal synchronization is also of importance. Associated frames, which contain the respective instantaneous values (samples) of the left and right channels, must not be delayed such that the timing tolerances of the receiver are exceeded. This can be noticed as omission or doubling of individual samples. The UPL can measure this shift as phase between the digital input on the front panel and the reference channel ('Ref In' connector on the rear panel).

In addition to the method described above which uses an external clock frequency (Sync PLL), the analyzer as a decoder and measuring instrument for the data contents itself (i.e. not as a jitter/phase meter or common-mode analyzer) can also be synchronized directly to the digital signal at the analyzer input via the menu item "Sync To". A difference has to be made between the input on the front panel (AUDIO IN) and the input of the reference receiver (REF IN) on the rear panel. Moreover, the analyzer can be synchronized also to the internal digital generator (GEN CLK).

## 2.6.4 Ways of Starting the Analyzer, Ext. Sweep

### Available for

all three ANALYZER instruments. No external sweeps are however possible in ANLG 110 kHz, i.e. in addition to the AUTO measurement mode only the time-triggered measurements (TIME TICK and TIME CHART) can be selected.

### Theory of operation

"START COND" determines when, how often or the conditions which must prevail to trace measured values.

Depending on the selection of START COND, the measured value is - when the conditions required for tracing of measured values are met - triggered, displayed in a UPL trace buffer. The trace buffer may contain up to 17 K (17408) measurement data depending on the application.

The measured value list can be displayed or represented in the form of graphics (see 2.10). If the options UPL-B10 or UPL-B4 are fitted, it can also be read in via a self-controlled program or external controller.

Depending on the selection of START COND, the measurement either starts immediately (AUTO) or only when the desired trigger condition is fulfilled.

With START COND not AUTO, an external sweep (START COND → FREQ CH1/2, FRQ FST CH1/2, VOLT CH1/2) or periodic measured value tracing (START COND → TIME TICK, TIME CHART) or armed single (START COND → LEV TRG CH1/2, EDG TRG CH1/2) is started using the START or SINGLE keys (see 2.11 Starting and Stopping of Measurements or Sweeps).

<b>START COND</b>	(Start Condition) specifies an event triggering off a measurement.
<b>AUTO</b>	Continuous measurement mode without trigger condition. The measured values are stored in the trace buffer only, if the frequency sweep of the selective RMS measurement or any generator sweep is active, simultaneously. The SINGLE or START keys allow you to switch between single and continuous measurement when no sweep is active. The AUTO mode must be activated to enable the sweep of the frequency of the selective rms measurement (see 2.6.5.3 RMS SELECT) or of the generator parameters (see 2.5.4.2). Several sweeps at the same time are not permissible and can therefore not be set.



**START COND**

<p><b>TIME TICK</b></p>
<p><b>TIME CHART</b></p>
<p><b>FREQ CH1 FREQ CH2 FRQ FST CH1 FRQ FST CH</b></p>

The measured values are triggered at regular intervals. The intervals for starting measurements are determined by the distance between the timeticks. The measured values are entered in the buffer and displayed in the measurement result window.

The START key is used to start a sequence of periodic tracings of measured values, which is restarted from the beginning when the number of sweep points specified under "Points" is reached.

If the timetick is greater than the measuring time, the next timetick is waited for after each single measurement; no measurement is performed during this period.

If the timetick is smaller than the measuring time, the next timetick is only triggered after completion of the measurement. The sweep is then indicated with corrected x-axis, i. e. the single measured values are entered with correct timing.

The SINGLE key allows you to start a single sequence of periodic tracings of measured values. The sweep enters the SWP TERMINATED state when the number of sweep points specified under "Points" is reached. The analyzer state is then "TERMINATED".

TIME cannot be simultaneously active with the frequency sweep of the selective rms measurement or any generator sweep!

Measured values (of the running continuous measurement) are entered in a time chart in the time pattern that can be entered under "Time". Contrary to TIME TICK, where a new (single) measurement is started with each tick and the result is only entered after completion of the measurement, TIME CHART also permits to display intermediate results. This is useful in particular in the case of quasi-peak measurements.

Tracing of measured values because a change in frequency was noted at ANALYZER input channel 1 or channel 2.

With the START or SINGLE key, an external frequency sweep is started, which in turn starts a single measurement on the occurrence of a trigger event or, as the case may be, after a delay to be entered. The measurement result is entered in the measured value buffer.

Starting a continuous sweep using the START key causes the sweep to be restarted after any change in frequency in the direction from stop to start frequency (see 2.11).

A single sweep started by the SINGLE key is stopped by a measured value beyond the stop frequency.

Changes of the frequency of STOP and START are ignored.

**Note:** *FRQ FST CH1/2 can be selected for especially fast frequency sweeps with clean signals (e.g. from the CD). If however the signal has a large noise component, the slower measurement procedure FREQ CH1/2 must be used.*

FREQ CH1|FREQ CH2-|FRQ FST CH1|FRQ FST CH2 cannot be simultaneously active with the frequency sweep in the RMS Select measurement or any generator sweep!

**Note:** *By activating the associated **settling**, unwanted interfering signals like voice can be made ineffective. It must be switched off with floating sweep.*

START COND	
<p><b>VOLT CH1</b> <b>VOLT CH2</b></p>	<p>A measurement result is recorded because a voltage change is detected at the analyzer input channel 1 or 2.</p> <p>With the START or SINGLE key an external voltage sweep is started, which in turn starts a single measurement upon a trigger event (or after a delay to be entered). The measurement result is stored in the buffer.</p> <p>When a continuous sweep is started with the START key, the sweep is restarted every time the voltage changes in the direction from the stop to the start level.</p> <p>If a single sweep is started with the SINGLE key, the sweep is stopped by a measured value beyond the stop level. Changes of the STOP and START voltages are ignored.</p> <p>VOLT CH1 VOLT CH2 cannot be simultaneously active with the frequency sweep of the selective RMS measurement or with any generator sweep.</p> <p><b>Note:</b> <i>In most cases (e.g. sliding sweep) it is advisable to perform an external voltage sweep with Settling switched on to prevent individual test points to be triggered too early by voltage transients. Two samples are sufficient for the settling parameters; the resolution should be set to minimum.</i></p>
<p><b>LEV TRG CH1</b> <b>LEV TRG CH2</b></p>	<p>Triggering (single shot) because of a <i>level</i> detected at analyzer input channel 1 or 2. Measured values are not stored in the trace buffers and, consequently, there is no graphical display via the X axis.</p> <p>Using the START or SINGLE key, level monitoring is enabled. It waits for the level to enter the range between Start and Stop for the first time. Then a single measurement is started - possibly after the entered delay.</p> <p>If the continuous trigger has been started with the START key, new triggering in the specified range takes place only if the level had been out of this range at the upper or lower end. Hence, level monitoring is only reactivated when a level is detected outside the specified range.</p>
<p><b>EDG TRG CH1</b> <b>EDG TRG CH2</b></p>	<p>Triggering (single shot) caused by a voltage <i>edge</i> detected at the analyzer input channel 1 and 2. The measured value is neither stored in the buffers nor graphically displayed via the X axis.</p> <p>Level monitoring is started with the START or SINGLE key but it is only activated when a level outside the start-stop interval is measured. Triggering is performed when a level occurs for the first time in the range between Start and Stop (edge trigger). A single measurement is then started - possibly after the specified delay.</p> <p>If continuous trigger has been started using the START key, new triggering in the specified range only takes place when the level had been out of the range at the upper or lower end. Hence, level monitoring is only reactivated when a level is detected outside the specified range.</p>

By pressing the STOP key, an external sweep is finished. By pressing the CONT key, the continuous measurement mode is started again.

## Delay

The menu items START COND →

AUTO | FREQ CH1 | FREQ CH2  
 FRQ FST CH1 | FRQ FST CH2  
 VOLT CH1 | VOLT CH2  
 LEV TRG CH1 | LEV TRG CH2  
 EDG TRG CH1 | EDG TRG CH2

allows the user to enter a delay time, which is useful for:

- Signal modifications at the generator (entry of values, variations via rotary knob)
- Sweeps
- Actuation of STOP/CONT or START keys (continuous measurement)
- SINGLE key actuation (single measurement)
- Modifications in the ANALYZER panel
- Modifications in the GENERATOR panel
- Modifications in the FILTER panel

Delay determines the waiting time required from the events stated above to the restart of a measurement in order to allow the device under test to settle.

Specified range: 50 ms to 10 s

Units: s | ms |  $\mu$ s | min

**Note:** Delay is considered in single measurements only, i.e. in single measurements triggered by the SINGLE key or sweep sequencing in the START COND → AUTO mode or on the occurrence of a trigger event in the START COND → FREQ CH1/2, VOLT CH1/2 modes.

During continuous measurements, delay is considered in the first measurement only. The following measurements are made without delay.

## Time

In the menu item START COND → TIME TICK | TIME CHART the intervals between the single tracings of measured values can be specified.

A single measurement is started after every time **tick**. A new measurement is only triggered when the last measurement has been completed. If a time tick is selected which is smaller than the measuring time, the time tick is adapted internally to the measuring time; i.e., it is extended to be identical.

With the start condition TIME **CHART**, the current measured value is entered upon expiry of the time entered, independent of the number of measured values obtained in the meantime, if any. If a time is selected which is smaller than the measuring time, the same result is traced several times (with different x-values). If this effect is to be avoided, "Time" must be increased.

Specified range: 10 ms to 2000 s

Units: s | ms |  $\mu$ s | min

Resolution: 1 ms

## Points

The menu item START COND → TIME TICK | TIME CHART allows the number of entries in the measured value buffer to be entered.

Specified range: 2 to 1024

**Note:** A time-tick scan is terminated after (points x time tick) seconds. If the individual measurements cannot be performed at the selected time-tick rate - due to an exceeded time-tick set - the trace buffer contains less than "points" measured values.

## Min VOLT

The menu items START COND →

FREQ CH1 | FREQ CH2  
FRQ FST CH1 | FRQ FST CH2

allow the entry of a minimum voltage to be applied to the ANALYZER input in order to trigger a measurement.

Specified range:

digital (audio data mode): 0.00001 to 1.0 FS  
analog: 0.00001 to 30 V

Units:

digital (audio data mode):  
FS | %FS | dBFS | LSBs | bits  
analog:  
V | mV |  $\mu$ V | dBu | dBV | dBm | W | mW |  $\mu$ W

## Start

The menu items START COND →

FREQ CH1 | FREQ CH2  
FRQ FST CH1 | FRQ FST CH2  
VOLT CH1 | VOLT CH2  
LEV TRG CH1 | LEV TRG CH2  
EDG TRG CH1 | EDG TRG CH2

## Stop

allow the entry of the start and stop values. The frequency or level applied to the ANALYZER input must not exceed the start/stop limits in order to trigger the measurement.

By single sweeps, the STOP value is used to recognize the end of the sweep. The STOP value should therefore be somewhat smaller than the expected signal range.

Specified range

- FREQ CH1 | FREQ CH2 FRQ FST CH1 | FRQ FST CH2:  
total range permitted (see 2.6.1)

- VOLT CH1 | VOLT CH2:  
analog: 10  $\mu$ V to 30 V  
V | mV |  $\mu$ V | dBu | dBV | dBm | W | mW |  $\mu$ W  
digital: LL to 1.0 FS  
FS | %FS | dBFS | LSBs | bits

LL: The lower limit for the level start/stop values depends on the number of audio bits (see 2.6.3), however must not be less than 1 $\mu$ FS. It can be calculated as follows:  
LL = 2<sup>-Audio Bits</sup>

**Variation**

The menu items START COND →

FREQ CH1 | FREQ CH2  
FRQ FST CH1 | FRQ FST CH2  
VOLT CH1 | VOLT CH2

allow the entry of a value in percent - or in dB (for high power ramping) – by which the input frequency or input voltage must be varied at least in order to trigger a measurement.

Changing the frequency or voltage in the direction from stop to start by this numeric value causes a restart of the sweep if continuous sweep has been set.

**Note:** *Select the variation 5 % to 10 % smaller than the expected change in order to guarantee reliable triggering on the one hand and to prevent triggering on intermediate values on the other hand.*

Specified range:

for frequency sweeps: LL to 50%

for level sweeps: LL to 900 % (= 20 dB)

Unit: % (for level sweeps also dB)

LL: The lower limit for the entry of variation is not less than 0.1% and is output such that not more than 1024 measured values are generated (depending on the spacing between start and stop values).

**Settling**

(see 2.6.5.1 Common Parameters of Analyzer Functions)

## 2.6.5 Functions

FUNCTION	
OFF	<b>Note:</b> The addition "&S/N" indicates that this function allows S/N measurements. No measurement function, measurement of Input RMS/PEAK and frequency/phase, however, enabled
RMS & S/N	True RMS measurement of AC voltages see 2.6.5.2
RMS SELECT	Selective RMS measurement with narrow bandpass see 2.6.5.32
PEAK & S/N	Maximum peak value within a monitoring interval, see 2.6.5.4
Q PK & S/N	Peak value detection with subsequent defined rising and falling times, see 2.6.5.4
DC	DC measurement, see 2.6.5.5
THD	Distortion measurement (without consideration of broadband noise), see 2.6.5.6
THD+N/SINAD	Distortion or SINAD measurement (including broadband noise), see 2.6.5.7
MOD DIST	Intermodulation measurement with high-frequency useful sinewave signal and a low-frequency interfering sinewave signal, see 2.6.5.8
DFD	Difference Frequency Distortion measurement by two adjacent tones with relatively high frequencies, see 2.6.5.9
WOW & FL	Wow and flutter measurement see 2.6.5.10
POLARITY	Polarity measurement to check for polarity reversal in a device under test, see 2.6.5.11
FFT	Graphical display of spectrum, see 2.6.5.12
FILTER SIM.	Filter simulation see 2.6.5.13
WAVEFORM	Waveform display; see 2.6.5.14.
PROTOCOL	evaluation and display of AES protocol data Only in the digital analyzer with measurement mode AUDIO DATA.
COHERENCE	Measurement of transfer function and coherence of two signals; with installed option UPL-B6 only, see 2.6.5.22
RUB & BUZZ	Loudspeaker measurements (rub&buzz, frequency response, polarity); with installed option UPL-B6 in the analog analyzers only, not available in the high rate mode (with option UPL-B29 installed), see 2.6.5.23
1/3-OCTAVE	1/3-Octave measurement, with installed option UPL-B6 only, not available in 110 kHz analyzer and in digital analyzer in the high rate mode (with option UPL-B29 installed), see 2.6.5.24

**Note:** The addition "&S/N" indicates that this function allows S/N measurements.

FUNCTION	(continued)
DIG INP AMP	Only with Jitter option (UPL-B22). This measurement function is selected under menu item INPUT DISP; see 2.6.5.16.
PHAS TO REF	Only with Jitter option (UPL-B22) This measurement function is selected under menu item INPUT/PHAS; see 2.6.5.17.

### 2.6.5.1 Common Parameters of Analyzer Functions

DC Suppress	(DC Suppress)
<p data-bbox="280 1413 323 1444"><b>ON</b></p> <p data-bbox="280 1541 336 1572"><b>OFF</b></p>	<p data-bbox="544 936 1417 1249">With the <b>digital</b> measurement functions RMS &amp; S/N, RMS SEL, FFT and Waveform, a DC component in the test signal can be suppressed so that it is present neither in the measurement result nor in the graphics display. To do so the actual DC value is determined for each measurement and then considered in the measured value by calculation. This preliminary measurement performed for FFT and Waveform requires additional measurement time (approx. 200 ms), but because of the relatively slow measurements this is in most cases not important. With RMS and RMS SEL measurements, the DC component is measured in parallel with the main measurement and does not therefore affect the measurement time.</p> <p data-bbox="544 1285 1417 1379"><b>Note:</b> <i>This menu item is not offered with <b>analog</b> measurements, as in this case the function is assumed by the selection of the input coupling (which is superordinate to the functions).</i></p> <p data-bbox="544 1415 1417 1509">The DC component of the signal to be measured is suppressed (AC coupling); only the AC component is considered in the measurement result.</p> <p data-bbox="544 1545 1417 1603">The DC content of the signal to be measured is <i>not</i> suppressed (DC coupling) and contained in the measurement result.</p>

<b>S/N Sequ</b>
<b>ON</b>
<b>OFF</b>

(S/N sequence)

The functions RMS & S/N, PEAK & S/N, Q-PK & S/N offer the possibility of S/N measurements (signal-to-noise). The generator signal at the device under test is alternately switched on (signal) and off (noise) and a measurement is performed in each case. During signal-on-phase the selected filters are turned off in order to exclusively weight the noise signal. The ratio of the two measured values in dB expresses the S/N ratio of the device under test.

Any desired generator setting is permissible.

A deactivated generator means:

- with analog generator instruments, the output voltage is switched off with the output resistance being constant
- with digital generator instruments, a level value of 0.0 full scale is output with the clock rate being unvaried (all bits to 0)

S/N measurement on

**Notes:**

- A filter with high-pass characteristic should be switched on in order to avoid measurement errors due to superimposed dc in the analog range. If this is not the case, a corresponding error message is displayed when switching on S/N mode.
- Measurement at low frequencies where a highpass is not usable should be performed using a file defined delay filter with about 1.5 s delay. By this means the DC-level that appears when switching off the generator can decay before noise measurement. is started.
- The selectable filters only affect the noise measurement. If they are to affect the signal measurement, too, this can be achieved by using the command line parameter "-o2".

S/N measurement off

Measurement function	selectable analog units:	selectable digital units:
Intermodulation measurements MOD DIST   DFD	%   dB	%   dB
Distortion measurements THD Meas Mode: SELECT di ALL even d ALL odd di ALL di	%   dB	%   dB
Meas Mode: SEL di LEV even di LEV odd di LEV di	V dBV dBu dBm W Δ %V ΔV V/V <sub>r</sub>  %V/V <sub>r</sub>  Δ %W ΔW P/P <sub>r</sub>  %P/P <sub>r</sub>  dB	FS %FS dBFS Δ % dB <sub>r</sub>  LSBs



Measurement function	selectable analog units:	selectable digital units:
<b>Distortion measurements THD+N</b> Meas Mode: THD+N   NOISE   SINAD	%   dB	%   dB
Meas Mode: LEVEL THDN   LEVEL NOISE	V   dBV   dBu   dBm   W   $\Delta$ %V   $\Delta$ V   V/V <sub>r</sub>   %V/V <sub>r</sub>   $\Delta$ %W   $\Delta$ W   P/P <sub>r</sub>   %P/P <sub>r</sub>   dB	FS   %FS   dBFS   $\Delta$ %   dB <sub>r</sub>   LSBs
<b>Wow and flutter measurements WOF&amp;FL</b>	%	%
<b>Transfer function (COHERENCE Trace A, Ch1/Ch2)</b>	%   dB	%   dB
<b>Coherence measurement (COHERENCE Trace B)</b>	$\gamma^2$	$\gamma^2$

Unit Ch1

Selection of the units of measurement results for channel 1.

Unit Ch2

Selection of units of measurement results for channel 2.

With all level measurements, the (display) units for the two channels can be selected independent of each other, e.g., in order to constitute one channel as absolute quantity and the other channel with any reference.

Selectable analog units (also valid for Meas Mode COMMON/INP in DIGITAL instrument):

V | dBV | dBu | dBm | W |  $\Delta$ %V |  $\Delta$ V | V/V<sub>r</sub> | %V/V<sub>r</sub> |  $\Delta$ %W |  $\Delta$ W | P/P<sub>r</sub> | %P/P<sub>r</sub> | dB<sub>r</sub>

Selectable digital units (Meas Mode AUDIO DATA):

FS | %FS | dBFS |  $\Delta$ % | dB<sub>r</sub> | LSBs | bits

The measurement functions PEAK and QPEAK as well as the INPUT DISP displays also allow the selection of the HEX unit.

Selectable jitter units (Meas Mode JITTER/PHAS):

UI | %UI | dBUI | ppm | ns | UI<sub>r</sub> | dB<sub>r</sub> (for jitter)  
 UI | %FRM | °FRM | ns (for phase)

For conversion formulae and notation of the measured value display units for IEC bus control, see 2.4 Units

Unit

Selection of units for measurement results for both channels. Measurements which usually have both channels with the same unit, provide a common menu item for both channels for selection of the (display) unit.

Basis of calculation see relevant measurement function.

Conversion formulas see 2.4 Units.

Reference	Reference values for the analyzer measurement function and the Input Disp measurement.
Value	<p>All measurements which obtain dimensional results, can be displayed either absolutely or referred to a reference. If a reference-related unit (to be recognized by the addition "r" or the prefix "Δ") is selected, the displayed result takes into consideration the reference entered here. Each measurement function and each of the superior functions provide their own reference, which applies for both channels, respectively. The selection made here is entered into the display panel per default, if an appropriate trace (FUNC CH1/2 or IMP RMS CH1/2) and the selected display reference is <i>not</i> FILE, HOLD or OTHER TRACE.</p> <p>Display and entry of a fixed reference value. Per default, this entry is entered into the display panel if an appropriate trace (FUNC CH1/2 or IMP RMS CH1/2) has been selected and the display reference has been set to VALUE. The specified range depends on the measurement function and the instrument function (analog or digital):</p> <p>Units:</p> <p>digital (audio data mode):  FS   %FS   dBFS   LSBs   bits   Δ%   dBr</p> <p>digital (jitter mode):  UI   %UI   dBUI   ppm   ns   UIr   dBr</p> <p>analog and digital common mode:  V   mV   μV   dBu   dBV   dBm   W   mW   μW</p> <p>Specified range for</p> <ul style="list-style-type: none"> <li>• DC measurement function: <ul style="list-style-type: none"> <li>digital (audio data mode): -100 to 100 FS</li> <li>analog: -1000 to 1000 V</li> </ul> </li> <li>• other (level) measurement functions and INPUT DISP: <ul style="list-style-type: none"> <li>digital (audio data mode): 100 pFS to 100 FS</li> <li>digital (jitter mode): 100 pUI to 100 UI</li> <li>analog (and common mode): 100 pV to 1000 V</li> </ul> </li> </ul> <p>The level measurement result of channel 1 or channel 2 is stored on pressing the ENTER key and displayed as new reference value. The reference value does not change during the measurement. These selection items are displayed with two-channel measurement, only.</p> <p>The result of a one-channel measurement is stored on pressing the ENTER key. The reference value does not change during the measurement. This selection item is displayed with one-channel measurement.</p>
STORE CH1 STORE CH2	
STORE	

Reference

MEAS CH1 MEAS CH2
DIG OUT AMP
GEN TRACK

Each level measurement result of channel 1 or channel 2 is immediately stored as the reference value and can then be used (by both channels) for a referenced display. A referenced unit must be selected in this case. These selection items are only available with 2-channel measurements.

Only for the display of the digital input amplitude (INPUT DISP: DIG INP AMP). The measured value is referenced to the digital signal level set in the digital generator (see 2.6.5.18, INPUT).

The current generator voltage and each newly set voltage of the function generator are stored as the reference value and can then be used (by both channels) for a referenced display. A referenced unit must be selected in this case.

**Exception:** *When the jitter is measured in the digital analyzer, the generator of the jitter signal is used as a reference. So, if the audio data come from the function generator and the jitter signal from the auxiliary generator, the jitter amplitude of the auxiliary generator is used as a reference.*

If the measured value is RMS-weighted, the RMS value of the generator voltage is used. If it is a peak value (INPUT DISP PEAK, PEAK function), the peak value of the generator voltage is used.

If the instrument functions of generator and analyzer are different (analog or digital), a **conversion factor** of

$$\frac{1 \text{ FS}}{1 \text{ V}}$$

is calculated.

**Note:** *The generator voltage selected in the panel is always used as reference instead of the actually output generator voltage. This applies, in particular, if equalization is switched on (cf. 2.5.4.3 SINE). If reference is to be made to the actually output voltage, the latter must be measured (internally) (CH1 Input GEN CH2) and the measurement result (of channel 2) must be referred to the measured voltage (Reference MEAS CH1).*

<b>Ref Freq</b>	<p>Reference Frequency Reference value for the frequency measurement. Results of frequency measurements can be displayed either absolutely or referred to a reference. If a reference-related unit (to be recognized by the addition "r" or the prefix "Δ") is selected, the displayed result takes into consideration the reference entered here; it applies for both channels or (with combined frequency/phase measurement or frequency/group-delay measurement) for the frequency of channel 1. The selection made here is entered into the display panel per default, if an appropriate trace (FREQ CH1/2) and the selected display reference is <i>not</i> FILE, HOLD or OTHER TRACE.</p>
<b>Value</b>	<p>Display and entry of a fixed reference value. Per default, this entry is entered into the display panel if an appropriate trace (FREQ CH1/2) has been selected and the display reference is set to VALUE.</p> <p>Specified range:           1 mHz to 1 MHz Units:                        Hz   kHz</p>
<b>STORE CH1 STORE CH2</b>	<p>The frequency measurement result of channel 1 and/or channel 2 is stored on pressing the ENTER key and displayed as new reference value. The reference value does not change during the measurement. This selection is provided with two-channel measurement, only.</p>
<b>STORE</b>	<p>The result of a one-channel frequency measurement or a combined FREQ&amp;PHASE measurement or FREQ&amp;GRPDEL measurement is stored on pressing the ENTER key. The reference value does not change during the measurement. This selection is provided with one-channel measurement, only.</p>
<b>MEAS CH1 MEAS CH2</b>	<p>Each frequency measurement result of channel 1 or channel 2 is immediately stored as the reference value and can then be used (by both channels) for a referenced display. A referenced unit must be selected in this case. <i>Not</i> available for 1-channel or combined frequency-phase measurements or frequency/group delay measurements.</p>
<b>GEN TRACK</b>	<p>The presently valid generator frequency and each newly set generator frequency are stored as the reference value and can then be used (by both channels) for a referenced display. A referenced unit must be selected in this case.</p>

**Note:** *The generator voltage selected in the panel is always used as reference instead of the actually output generator voltage. This applies, in particular, if equalization is switched on (cf. 2.5.4.3 SINE). If reference is to be made to the actually output voltage, the latter must be measured (internally) ( CH1 Input GEN CH2) and the measurement result (of channel 2) must be referred to the measured voltage (Reference MEAS CH1).*

<b>Ref Phase</b>
<b>VALUE</b>
<b>STORE</b>

(Reference Phase)

Reference value for the phase measurement.

This menu line is displayed only, if two-channel measurement and the phase or group-delay measurement have been selected.

Results of phase and group-delay measurement can be displayed either absolutely or referred to a reference. If a reference-related unit (to be recognized by the prefix "Δ") the result is displayed taking into consideration the reference entered here.

Display and entry of a fixed reference value.

Per default, this entry is entered into the display panel if an appropriate trace (FREQ CH1/2) has been selected and the display reference is set to VALUE.

**Specified range and units for:**

- phase measurement:  
 Specified range: - 360° to +360° or -2π to +2π  
 Units: ° | RAD
- group-delay measurement:  
 Specified range: - 10 s to +10 s  
 Units: s | ms | μs | min.

The results of phase or group-delay measurement are stored on depression of the ENTER key and displayed as new reference value. The reference value does not change during the measurement.

<b>FILTER</b>
---------------

For the functions in the ANALYZER panel

- RMS & S/N (RMS measurement), 3 filters
- PEAK & S/N (peak measurement), 3 filters (\*)
- QPK & S/N (quasi-peak measurement), 3 filters (\*)
- THD+N/SINAD (distortion measurement) 1 filter
- RMSSEL (selective RMS measurement) 1 filter
- FILTSIM (filter simulation) 3 filters
- RUB & BUZZ (loudspeaker measurement) 2 filter
- WAVEFORM (DIGITAL or ANLG22kHz) 1 filter (\*)
- 1/3-OCTAVE 1 filter (\*)
- FFT 3 filter (\*)

can be selected and assigned to the ANALYZER function (see 2.7 Analyzer Filters (FILTER Panel)).

**Note:** Apart from these filters of digital design, an analog notch filter can be switched on additionally with the analog measurement functions RMS, RMS SELECT, QPK and FFT for elimination of individual frequency lines (see menu item Notch (Gain) in this section).

**UPL-B29:** The functions marked (\*) can be operated without filter only in the high rate mode as well as in ANLG 110 kHz analyzer.



**Notch (Gain)**

- OFF
- 0 dB
- 12 dB Auto
- 30 dB Auto

For the functions RMS & S/N, RMS SELECT, Q PK & S/N and FFT, the three analog analyzers offer an analog notch filter of 2nd order to be activated for narrow-band suppression of interfering frequency lines. With notch switched on, one of 3 gain factors can be selected:

- Analog notch filter off
- Analog notch filter on; no gain effective
- Analog notch filter on; gain 12 dB
- Analog notch filter on; gain 30 dB

**Note:** If frequency components occur outside the analyzer frequency range, the notch gain may cause the analyzer to be overdriven. In this case, the notch gain is reduced step by step, which is to be indicated by adding "Auto" in the items 12 dB and 30 dB.

**Notch Freq**

- AUTO
- VALUE
- GEN TRACK

Selection of the notch-filter center frequency.

Center frequency of the notch filter tracks the measured frequency.

Numerical entry of the notch filter center frequency

Specified range: 10 Hz to 22,5 kHz

Units: Hz, kHz

Switching on VALUE causes the latest valid notch frequency to be displayed. When switching over from AUTO to VALUE, e.g., and the (external) test signal having a frequency of 117 kHz, the frequency displayed is 110 kHz.

With the generator signal function set to SINE, BURST, SINE2 PULSE or SQUARE, the current generator frequency specified under generator menu item FREQUENCY is used as notch filter center frequency. Any other signal function leads to an error message.

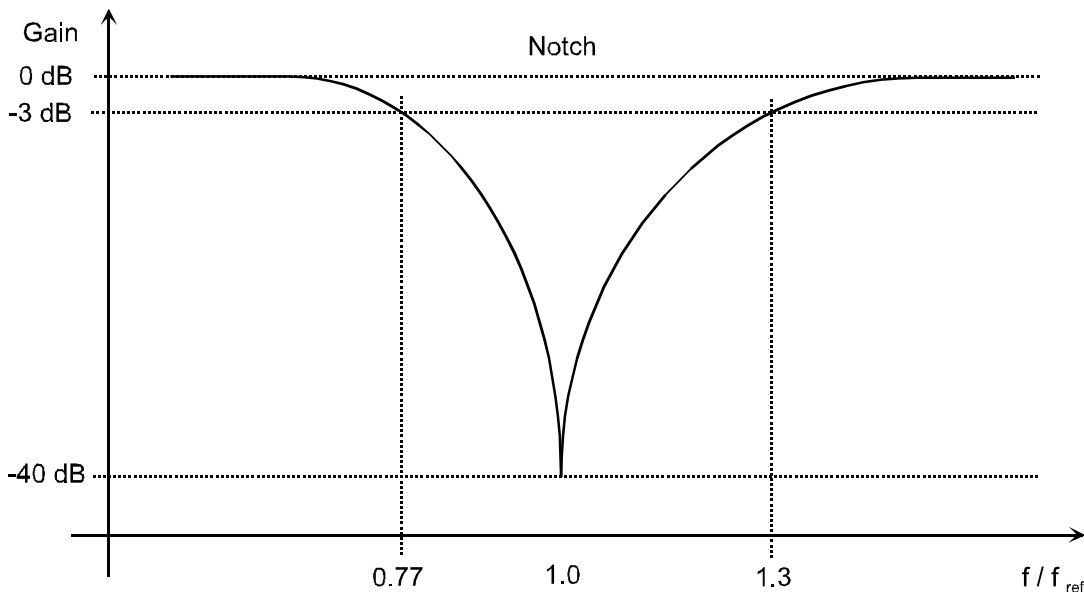

Fig. 2-20 Characteristic of analog notch filter

**Application example: quantising noise measurement**

The notch filter being subsequent to the input level stage, the fundamental wave level determines the dynamic range of the input circuit. The measurement range in which the fundamental wave is measured therefore determines the dynamic range of the quantising noise measurement.

Settling  
Freq Settl  
Phas Settl  
Funct Settl

OFF  
  
EXPONENTIAL  
  
FLAT  
  
AVERAGE

Most measurements can be subceded by a settling or averaging procedure in order to obtain settled measured values even with settling DUTs.

Exceptions and special features:

- Settling cannot be realized with *group-delay measurement*, since the measured value is defined with varying frequency, only.
- From the physical point of view, settling is not required with the measuring functions *POLARITY* and *FILTSIM*
- The *WAVEFORM* function does not allow for selection of settling, but averaging (menu item Interpol).
- The *FFT* function does not allow for selection of settling, but it provides two different averaging modes (menu item Avg Mode NORMAL or EXPONENTIAL).
- The *1/3-OCTAVE* function does not allow for selection of settling; averaging is provided by setting of the measurement time.
- In the measurement modes *JITTER/PHAS* and *COMMON/INP* Settling cannot be selected, but with measurement functions *FFT* and *WAVEFORM* the averaging modes described above.

Settling process switched off; measurement result available in the shortest possible time. This setting should always be selected if maximum measuring speed is required.

Settling with exponential course of the tolerance and resolution.

Settling with horizontal course of tolerance and resolution.

Arithmetic averaging of the results

*For further information, cf. 2.3.4 Settling Process*

Samples

To menu item Settling → EXPONENTIAL | FLAT:

Number of subsequent measured values compared in the settling proces  
If value 6 is entered here, this means that the latest measured value compared to 5 preceding measured values.

Specified range: 2 to 6

To menu item Settling → AVERAGE

Number of measured values used for arithmetic averaging.

Specified range: 2 to 100



## Tolerance

To menu items Settling → EXPONENTIAL | FLAT:

The tolerance value denotes the maximally permissible deviation from the preceding measured value a settled measured value may have in order to be classed as valid by the UPL.

The value of the maximally permissible deviation of the current measured value compared to the 2nd/3rd/4th and 5th last measured value is determined by the setting EXPONENTIAL | FLAT .

For further information, cf. 2.3.3 "Settling Process"

Unit: % or dB (not WOW & FL and frequency measurement)

Specified range: 0.001 % to 10 % or  
0.000087 dB to 0.828 dB

% and dB values can be converted into one another:

$$\% \text{ value} = \left(10^{\frac{\text{dB-value}}{20}} - 1\right) \times 100$$

$$\text{dB value} = 20 * \lg \left(\frac{\% \text{-value}}{100} + 1\right)$$

## Resolution

To menu items Settling → EXPONENTIAL | FLAT:

Measured value resolution considered if the measured value does not satisfy the tolerance limits.

For further information, cf. 2.3.4 Settling Process

**Specified range and units** depend on instrument and measurement function:

- RMS & S/N | RMS SELECT | PEAK & S/N | Q PK & S/N | DC / external level sweep:  
analog: 0.1 μV to 10 V; V|mV|μV|dBV|dBu|W|mW|μW|dBm  
digital: Min. FS to 0.1 FS; FS |% FS |dBFS |LSBs |bits |Δ% |dBr
- THD+N/SINAD | THD | MOD DIST | DFD | WOW & FL:  
0.000001 % to 10 %; % | dB
- Frequency measurement / external frequency sweep:  
100 μHz to 10 Hz; Hz | kHz
- Phase measurement:  
0.0001 ° to 10 ° ° | RAD

Min. FS: 2<sup>(-1 \* audio bits)</sup> however, not less than 1 μFS

**Exception:** a resolution of down to 1 nFS can be entered for the external level sweep so that the setting procedure can also be used for very small levels.

**Time-out**

If the settling mechanism does not recognize a stabilization of the measured value within the time stated under "time-out", the test loop is aborted and "Input - Press SHOW I/O" output instead of a measured value. A gap points to the missing value in the graphical curve display of a sweep.

For further information, cf. 2.3.4 Settling Process

Specified range: 0.001 to 10 s

Unit: s

**Recommended Values:**

For the majority of measurements on AF instruments, the following settings are suitable:

- Settling EXPONENTIAL
- Tolerance 1% (approx. 0.1 dB)
- Resolution: value of the last but one digit displayed in the result window, e.g., with a displayed value of 10.0000 Hz, this is 1 MHz
- Time-out 1 s

**SPEAKER**

cf. 2.6.6 Headphone/Speaker Output

**Pre Gain**

cf. 2.6.6 Headphone/Speaker Output

**Spk Volume**

cf. 2.6.6 Headphone/Speaker Output

**Phone Out**

cf. 2.6.6 Headphone/Speaker Output

### 2.6.5.2 RMS (incl. S/N)

Available in all analyzers.

#### Analog mode:

True rms measurements of AC voltages (frequency ranges of the analog ANALYZER instruments, see 2.6.1 Selecting the Analyzer) of any desired waveform up to 100 V. Depending on the selected coupling, a superimposed dc is either measured (dc coupling) or not measured (ac coupling)

#### Digital mode:

The signal contents is indicated as true rms full-scale value from 0.0 to 1.0. A superimposed dc is either measured or suppressed depending on the selection "DC Suppress":(OFF) or (ON).

**Note:** *If all converter bits are set, 1.0 FS (= 0.0 dBFS) is displayed.*

#### Frequency measurement:

Particularly fast frequency measurement is enabled with RMS (and RMS SELECT). To this end, the frequency measurement must be switched on "Meas Time" must be set to FAST. Although this frequency measurement only negligibly increases the total measuring time, it should be renounced for extremely fast measurements, (GEN TRACK or very short VALUE) in particular with very weak signals.

S/N Sequ

(see 2.6.5.1 Common Parameters of Analyzer Functions)

DC Suppres

Selectable in the digital analyzer only;  
corresponding setting required for analog analyzers: AC/DC coupling,  
see 2.6.2 Configuration of the Analog Analyzers

**Note:** *DC suppression is only effective for the measured RMS value. With post-FFT a DC component is displayed even if DC suppression is switched on. A DC-free FFT display can only be obtained with the FFT measurement function.*

## Meas Time

AUTO FAST  
AUTO

(Measure Time)

The rms measurement time serves to match the measurement rate to the signal frequency. It depends on the measurement requirements whether a short measuring time or high accuracy will have priority.

Automatic matching of the measuring time to the signal frequency with consideration of the signal period. The measuring time is matched as far as possible to the input signal; with AUTO FAST, a maximum algorithmic error of 1% (with AUTO: 1‰) may arise. With very weak signals, the measuring time is limited to 1 period according to Min Freq.

**Notes:**

- . *In the case of very noisy or distorted signals or multitone signals, the automatic measurement modes - particularly AUTO FAST - may not be able to detect the signal period. To avoid measurement errors, these signals should preferably be measured with GEN TRACK or - if an external generator is used - with the measurement mode VALUE.*
- . *To allow automatic-mode measurement of the signals described under 1 with the advantage of high measurement speed, the minimum measurement is optimized automatically. Only the first measurement – without post-FFT – is performed using the high measurement speed. For all other measurements the measurement time is increased to 100 ms or the measurement time of post-FFT, respectively, which enables higher accuracy. This means that the first triggered measurement result (eg. when sweeping) is obtained very fast, while the subsequent results are more accurate.*

Meas Time	
	<p><b>VALUE</b></p> <p>(Measure Time)</p> <p>Numeric entry of desired measuring time. Since measurement errors may occur when the measuring time is not matched to the period, this mode should be selected only if the period of the signal is exactly known or no other measuring mode can be used. The measurement time should be an integral multiple of the period (to <i>avoid</i> errors due to termination of measurements) or at least much longer than the period time (to <i>minimize</i> such errors).</p> <p>Specified range:            ANLG 22 kHz: 100 <math>\mu</math>s to 10 s            ANLG 110 kHz: 100 <math>\mu</math>s to 0.3 ms            DIGITAL: 100 <math>\mu</math>s to 10 s            Units: s   ms   <math>\mu</math>s   min</p>
	<p><b>TRIGGERED</b></p> <p>Special measurement mode; a single measurement (with selectable measuring time) is performed, as soon as the signal first exceeds a trigger threshold (also selectable). This measurement mode, in conjunction with a bursted generator signal, allows for measurement of the <i>first period</i> of a signal.</p> <p><b>Application:</b> <i>Anechoic measurements on loudspeakers, measurement of short signal pulses.</i></p> <p><b>Notes:</b></p> <ol style="list-style-type: none"> <li>1. Only single-channel measurements should be performed.</li> <li>2. A fixed voltage range should be set in the analog analyzer. Activation of the auto ranger would delay the beginning of the measurement.</li> <li>3. No filters and no settling can be selected.</li> <li>4. Triggering on level thresholds can also be selected using "START CONDition LEV TRG CH1/2". <b>Any</b> measurement function (e.g. "WAVEFORM") can be selected. The measurement mode described here can, however, be used for RMS measurements only. Advantage: the measurement starts <b>without delay</b>.</li> </ol>
	<p><b>GEN TRACK</b></p> <p>Measurement over (at least) one whole period of the generator signal. If required, the generator frequency is matched to the analyzer sampling rate. In the case of high frequencies the measurement time is extended to several periods to increase the measurement accuracy. Particularly suitable for measuring very noisy or distorted signals and for extremely fast sweeps.</p> <p>The period length is calculated from the signal frequency entered in the generator panel which is why this measuring mode should only be used with use of the UPL <i>function</i> generator.</p> <p><b>Notes:</b></p> <ol style="list-style-type: none"> <li>1. If the MODDIST signal is used as generator signal, the measurement time is referred to the LOWER Frequency, which normally dominates.</li> <li>2. If CODED AUDIO is used as the generator signal, the generator frequency cannot be adjusted due to the coarse frequency spacing. Slight</li> </ol>

*inaccuracies might occur which is why the measurement speed AUTO is recommended.*

- If ARBITRARY is used as the generator signal, the measurement time is synchronized to the number of samples in the file loaded. Thus, the measurement always involves a full period of the ARB signal (which is output repetitively).*

When using the low-distortion generator, small frequency offsets may occur which may lead to a reduction of the measuring accuracy if the measuring time is coupled to the rated frequency. The measurement rate AUTO should be used in these cases.

The fixed integration time specified with VALUE (without consideration of the signal period) leads to the following consequences depending on the meas. time/signal period ratio:

- Meas Time is integer multiple of signal period:  
Optimum integration effect. Steady display!
- Meas Time larger than, yet no integer multiple of signal period:  
Integration effect, however beats occur in the display.
- Meas Time smaller than signal period:  
No integration effect. AC measurement result follows the signal waveform.

**Unit Ch1/2**

(see 2.6.5.1 Common Parameters of Analyzer Functions)

**Reference**

(see 2.6.5.1 Common Parameters of Analyzer Functions)

**Sweep Mode**

**NORMAL**

**BLOCK**

Displayed only in ANLG 22 kHz and DIG 48 kHz analyzers.

This menu item is provided to increase the speed of frequency sweeps with the universal generator of the UPL.

**UPL-B29:** *In the high rate mode, the sweep can be operated at normal speed only; the menu item **Sweep Mode** is therefore not offered.*

To increase the sweep speed the following **conditions** have to be fulfilled by the **generator**:

- Function                 SINE
- Low distortion         OFF
- Sweep control         AUTO ...
- X axis                    FREQ
- Z axis                    OFF

Normal sweep trigger without additional speed optimization; may be used for any kind of sweep.

This setting is used internally whenever one of the conditions for optimized sweep synchronization is not met, e.g. in the "learn mode" (see below).

Speed-optimized sweep:

The 1st sweep is always performed with the speed set under NORMAL. During this sweep the generator parameters for the subsequent sweeps are learned and stored (learn mode).

As long as no settings are done in the instrument, the BLOCK mode can use the learned parameters as from the 2nd sweep (play mode) so that setting times for the individual sweep points are considerable shortened. For reasons of speed, measured values are not indicated. Traces are displayed when the sweep is completed.

During a sweep the instrument cannot be operated. If one or several keys are pressed during the sweep, the current sweep is terminated and the unit returns to the learn mode where the functions of the pressed keys are performed.

**Note:**         *Settling cannot be switched on in the block mode.*

**Notch (Gain)**

(see 2.6.5.1 Common Parameters of Analyzer Functions)

**Filter**

(see 2.7 Analyzer Filters (FILTER Panel))  
Maximum 3 filters can be selected.

**Funct Sett**

(see 2.6.5.1 Common Parameters of Analyzer Functions)

**Post FFT**

(see 2.6.5.1 Common Parameters of Analyzer Functions)

Switching on the POST FFT improves the digital frequency-measurement result for frequencies above 4 times the FFT resolution. This can be noticed in particular with high frequencies and/or noisy signals.

POST FFT is switched on coercively, if phase or group-delay measurement is switched on - with two-channel measurement. Since these measurements cannot be performed unless (POST) FFT is selected, the latter cannot be switched off until frequency measurement is set OFF or to FREQ again.

The POST FFT is switched off automatically with selecting TRIGGERED measuring time or switching on S/N measurement.

**Note:** *With active Post-FFT a DC part that might exist is always displayed in the FFT spectrum, e.g. even when DC suppressing is switched off. A DC free FFT display can be achieved via measurement function FFT.*

**Trig Level**

(Trigger level); is displayed with Meas Time TRIGGERED, only.

Sets the trigger threshold which determines the start of the RMS measurement. The trigger level applies in relation to the full-scale value selected under menu item Ch1/2 Range as fixed voltage range.

Specified range: -240 to 0 dB

Unit: % or dB

**SPEAKER**

(see 2.6.5.1 Common Parameters of Analyzer Functions)



**2.6.5.3 RMS SELECT (Selective RMS Value)**

Available in all analyzers. Selective RMS measurement with narrow bandpass or bandstop.

**DC Suppres**

Selectable in the digital analyzer only;  
corresponding setting for analog analyzers:  
"Coupling AC/DC", see 2.6.2 Configuration of the Analog Analyzers

Meas Time	
<p><b>AUTO FAST AUTO</b></p>	<p>(Measure Time) serves to match the measurement rate to the signal frequency. It depends on the measurement requirements whether a short measuring time or high accuracy will have priority.</p> <p>Automatic matching of the measuring time to the signal frequency with consideration of the signal period. The measuring time is matched as far as possible to the input signal; with AUTO FAST, a maximum algorithmic error of 1% (with AUTO: 1‰) may arise. With very weak signals, the measuring time is limited to 1 period according to Min Freq.</p> <p><b>Notes:</b></p> <ol style="list-style-type: none"> <li><i>In the case of very noisy or distorted signals or multitone signals, the automatic measurement modes - particularly AUTO FAST - may not be able to detect the signal period. To avoid measurement errors, these signals should preferably be measured with GEN TRACK or - if an external generator is used - with the measurement mode VALUE.</i></li> <li><i>To allow automatic-mode measurement of the signals described under 1 with the advantage of high measurement speed, the minimum measurement is optimized automatically. Only the first measurement is performed using the high measurement speed. For the following measurements the measurement time is increased to 100 ms, which enables higher accuracy. This means that the first triggered measurement result (eg. when sweeping) is obtained very fast, while the subsequent results are more accurate.</i></li> </ol>
<p><b>VALUE</b></p>	<p>Numeric entry of desired measuring time. Since measurement errors may occur when the measuring time is not matched to the signal period, this mode should only be used if the signal period is exactly known or the other measurement modes cannot be used. The measuring time should be an integral multiple of the period (to <i>avoid</i> errors due to termination of measurement) or be at least much longer than the period (to <i>minimize</i> such errors).</p> <p>Specified range:</p> <p>ANLG 22 kHz: 100 <math>\mu</math>s to 10 s  ANLG 110 kHz: 100 <math>\mu</math>s to 0.3 ms  DIGITAL: 100 <math>\mu</math>s to 10 s</p> <p>Units: s   ms   <math>\mu</math>s   min</p>
<p><b>GEN TRACK</b></p>	<p>Measurement over (at least) one whole period of the generator signal. If required, the generator frequency is matched to the analyzer sampling rate. In the case of high frequencies the measuring time is extended to several periods to increase the measurement accuracy. Particularly suitable for measuring noisy or distorted signals and for very fast sweeps.</p> <p>The period length is calculated from the signal frequency entered in the generator panel which is why this measuring mode should only be used with use of the UPL <i>function</i> generator.</p> <p><b>Notes:</b></p> <ol style="list-style-type: none"> <li><i>If the MODDIST signal is used as generator signal, the measurement time is referred to the LOWER Frequency, which normally dominate</i></li> <li><i>When using the low-distortion generator, small frequency offsets may occur which may lead to a reduction of the measuring accuracy if the measuring time is coupled to the rated frequency. The measurement rate AUTO should be used in these cases</i></li> </ol>

*offsets may occur which can lead to a reduction of the measuring accuracy if the measuring time is coupled to the rated frequency. The measurement rate AUTO should be used in these cases.*

<b>Unit Ch1/2</b>	(see 2.6.5.1 Common Parameters of Analyzer Functions)
<b>Reference</b>	(see 2.6.5.1 Common Parameters of Analyzer Functions)
<b>Bandwidth</b>	Bandwidth of bandpass (BP) or bandstop (BS)
<b>BP 1% BS 1%</b>	Geometrically symmetrical bandwidth 1%
<b>BP 3% BS 3%</b>	Geometrically symmetrical bandwidth 3%
<b>BP 1/3 OCT BS 1/3 OCT</b>	Geometrically symmetrical bandwidth ≈ 23% (obtained from $\sqrt[3]{2} - \frac{1}{\sqrt[3]{2}} = 0.2315 = 23.15\%$ )
<b>BP 1/12 OCT BS 1/12 OCT</b>	Geometrically symmetrical bandwidth ≈ 6% (obtained from $\sqrt[12]{2} - \frac{1}{\sqrt[12]{2}} = 0.0577 = 5.77\%$ )
<b>BP FAST BS FAST</b>	same as BP/BS 1/3 OCT, for 40 dB attenuation only but with considerably shorter settling time.
<b>BP FIX: BS FIX:</b>	Arithmetically symmetrical bandwidth using numerical entry

Analyzer	Range for bandwidth
ANLG 22 kHz	9.9 Hz to 16 kHz
ANLG 110 kHz	70.4 Hz to 113.8 kHz
DIGITAL	$f_{cmin} * 0.99... \frac{\text{sample freq.}}{3}$

$$f_{cmin} = \frac{\text{sample freq.}}{4800} \text{ (minimum center freq.)}$$

Units: Hz, kHz

**Note:** For Third Octave filters the 0,1dB-bandwidth is reduced in order to obtain an attenuation of 3 dB at the cut-off frequencies. Hence the effective bandwidth is lower than the theoretical value.

**Note:** It may occur in the analog analyzer 110 kHz that the selection filter cannot settle - due to low frequencies and narrow passband or stopband. If this is the case,

- increase the passband or stopband, or
- increase the filter center frequency, or
- use the analyzer 22 kHz.

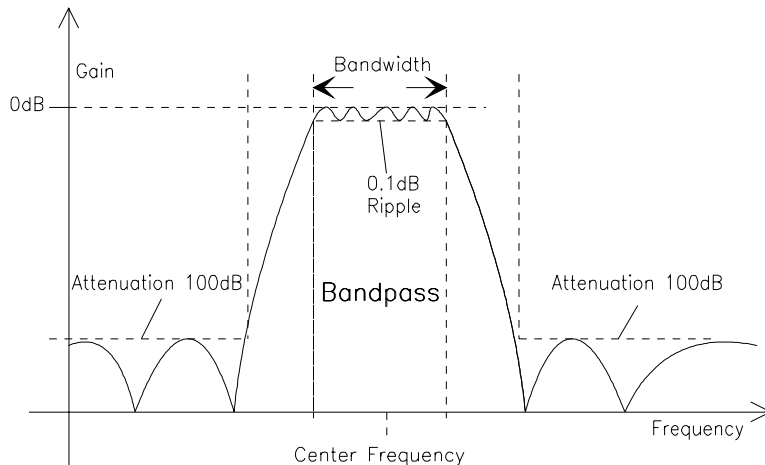

Fig. 2-21 Bandpass used for selective rms measurement

### Frequency Sweep of Selective RMS Measurement

The band center frequency of the selective rms measurement can be swept using various procedures. A table with a maximum of 1024 frequency entries is generated. As desired, the individual frequency points can be

- calculated from user specifications (SWEEP CTRL → AUTO SWEEP | MANU SWEEP)
- loaded from file as list sweep (SWEEP CTRL → AUTO LIST | MANU LIST)
- derived from the individual frequencies of generator MULTISINE (SWEEP CTRL → GEN MLTSINE).

#### SWEEP CTRL

(Sweep Control)

is used to select whether and how to sweep the band center frequency. The notch frequency of the switch-selectable analog notch filter is swept additionally, with analog analyzers.

**OFF**

The sweep system is switched off. The band center frequency can be selected via menu item FREQ MODE (see below).

**Note:** *With this setting, the sweep system is available for generator or analyzer sweeps. By selection of FREQ MODE and switching on a generator frequency sweep or external frequency sweep the band center frequency can be swept over the generator frequency or over the frequency of an external generator.*

**AUTO SWEEP**

Pressing the START or SINGLE key causes the sweep to run automatically (see 2.11 Starting and Stopping of Measurements or Sweeps).

The sweep parameter data are calculated from the user specifications (start/stop values and step size or number of points); “normal” sweep

SWEEP CTRL	
<b>AUTO LIST</b>	<p>Pressing the START or SINGLE key causes the sweep to run automatically (see 2.11 Starting and Stopping of Measurements or Sweeps).</p> <p>The sweep parameter data are read from a file (list sweep);</p>
<b>MANU SWEEP</b>	<p>The sweep is controlled by means of the rotary knob and/or cursor keys. After pressing the START key, only the first frequency of the selective rms measurement is set. Any further frequency is requested using the rotary knob or by pressing a cursor key (see 2.11 Starting and Stopping of Measurements or Sweeps).</p> <p>When sequencing the manual sweep, the result of the current measurement is not waited for, i.e., the current RMS SELECT measurement and an analyzer delay, if set, are aborted.</p> <p>As with AUTO SWEEP, the sweep parameter data are calculated from the user specifications (start/stop values and step size or number of points); "normal" sweep</p>
<b>MANU LIST</b>	<p>The sweep sequence is similar to MANU SWEEP; the sweep parameter data are, however, read from a file (similar to AUTO LIST); (List Sweep).</p>
<b>GEN MLTSINE</b>	<p>(Generator multisine)</p> <p>The band center frequency of selective RMS measurement is subsequently set to the multisine frequencies entered in the generator panel (see 2.5.4.4 MULTISINE). The generator signal function is assumed to be set to MULTISINE.</p> <p>This setting is used for fast measurement of the frequency response. The sweep runs automatically upon depression of the START or SINGLE key (see 2.11 Starting and Stopping of Measurements or Sweeps).</p>

**Notes on manual sweep:**

In order to control manual sweeps using the rotary knob or the cursor keys, the graphics panel must be active (full-screen or part-screen mode). When the sweep is started, the switchover to the graphics panel occurs automatically. The feature "manual sweep" can be used to vary the band center frequency with a user-definable increment. The increment is defined by a fixed STEP (with MANU SWEEP) or by a variable step size defined in a file (with MANU LIST). With remote control, the command "INIT:NEXT<n>" is used to continue.

Subsequent to setting a new sweep point, a continuous measurement is performed on this point. All measured values thus obtained can be read off from the display or from the curve plot (in the form of crosses). With sweep sequencing, the value *last* measured is stored.

By turning the rotary knob fast, individual sweep points can be skipped (to be recognized as gaps in the graphical curve display), or repeated by turning the rotary knob back.

The measured values are indicated by crosses in the Curve Plot mode. If Scan count >1 has been selected in the display panel, the crosses are not deleted prior to a new character, but remain on the screen. With strongly fluctuating measured values, the representation approximately takes the shape of a bar. If sweep steps are skipped or advanced too fast, a NAN value (Not A Number) is entered. When reaching the end of the sweep, the complete trace (with the last measured values, respectively) is obtained.

**Spacing**

- LIN POINTS**
- LIN STEPS**
- LOG POINTS**
- LOG STEPS**

Spacing of the sweep ranges for menu items

SWEEP CTRL → AUTO SWEEP | MANU SWEEP

The sweep range between Start and Stop is linearly spaced by a number of points which is to be entered under menu item "Points".

The step size in Hz can be derived from the number of linear points:

$$Step[Hz] = \frac{|Stop[Hz] - Start[Hz]|}{Points - 1}$$

**LIN STEPS**

The sweep range between Start and Stop is spaced in frequency intervals determined by the linear step size in Hz which is to be entered under menu item "Step".

The number of points can be calculated from the linear step size in Hz:

$$Points = \frac{|Stop[Hz] - Start[Hz]|}{Step[Hz]} + 1$$

**LOG POINTS**

The sweep range between Start and Stop is logarithmically spaced by a number of points to be specified under menu item "Step".

The multiplier for the step size can be derived from the number of logarithmic points:

$$Step = \left( \frac{Stop[Hz]}{Start[Hz]} \right)^{\frac{1}{Points-1}}$$

**LOG STEPS**

The sweep range between Start and Stop is spaced using a logarithmic step size which is to be entered under menu item "Step" as multiplier without unit.

**Note:** When switching from ...POINTS to ...STEPS, no conversion is performed. The set values are retained in the background. When switching between LIN STEPS and LOG STEPS, the numerical value specified for "Steps" remains the same.

**Start**

Displayed with normal sweep only (SWEEP CTRL → AUTO SWEEP | MANU SWEEP).

**Stop**

Entry of the start and stop value for the sweep of the band center frequency.

For the specified range and units, see FREQ MODE → FIX.

**Points**

Displayed with normal sweeps (SWEEP CTRL → AUTO SWEEP | MANU SWEEP) if the spacing LIN POINTS or LOG POINTS has been selected.

Enter the number of points for the frequency sweep of the band center frequency.

Specified range: 2 to 1024  
 Units: integer value without unit

**Step**

Displayed with normal sweeps (SWEEP CTRL → AUTO SWEEP | MANU SWEEP) if LIN STEPS or LOG STEPS has been selected with Spacing.

Enter the step size for the frequency sweep of the band center frequency.  
 Specified range:  
 The step size must be selected such that max. 1023 single steps (= 1024 sweep points) result. The step size must not be larger than the absolute difference between Stop and Start.  
 For the valid specified range, see operator guidance line.

Units with	Spacing → LIN STEPS:	Hz   kHz
	spacing → LOG STEPS:	no unit, because of multiplier

**Filename**

Displayed with list sweeps only (SWEEP CTRL → AUTO LIST | MANU LIST) if LIN POINTS or LOG POINTS has been selected.

File containing the frequency values for the frequency sweep of the band center frequency. (For the format of the sweep lists, see Appendix).

**FREQ MODE**

- FIX**
- GEN TRACK**
- FREQ CH1**  
**FREQ CH2**

Displayed with bandpass center frequency switched off, only (SWEEP CTRL → OFF).

Specification of the band center frequency.  
With analog analyzers, this implies specification of the notch frequency of the switch-selectable analog notch filter.

Numerical entry of a fixed bandpass center frequency, i.e., also notch frequency, if notch switched on (menu line NOTCH (Gain) in the analog analyzers).  
The minimum and maximum possible center frequency is determined by the instrument selected and the bandwidth specified and displayed in the operator guidance line. (For table with values, see below.)

For other measurement spheres, the generator can be swept, however does not cause any change in frequency of the selective rms measurement.

(Generator tracking)  
The bandpass center frequency - and also the notch frequency (menu line Notch(Gain) in the analog analyzers), if switched on - tracks the generator frequency. This can be varied by the user (entry of value, rotary knob in menu item "FREQUENCY" of the generator) or by a generator frequency sweep.  
By means of the factor entered in the next menu line it can be determined whether the center frequency should directly track the generator frequency (factor = 1) or be a multiple thereof. If the factor is an integral multiple, it may be used for measuring single harmonics.  
The bandpass center frequency can be tracked to the generator signal functions SINE, MULTISINE, BURST or SINE2 PULSE", only; any other signal function causes an error message.

**Note:** *When using the low-distortion generator, small frequency offsets may occur which may lead to incorrect measurements if the band center frequency is coupled to the rated frequency and the actual frequency is out of the selected passband or stopband. The measured frequency should be used in these cases (FREQ MODE MEAS CH1/2).*

The bandpass center frequency - and also the notch frequency (menu line Notch(Gain) in the analog analyzers), if switched on, tracks the frequency measured on channel 1 or 2.

**Note:** *Switching over the input channels 1↔2 causes the frequency mode FRQ CH1 ↔ FRQ CH2 to be switched over, too.*



**Factor**

Displayed only with FREQ MODE → GEN TRACK.

Specifies the factor by which the center frequency of the bandpass or bandstop filter is higher than the generator frequency. An integral factor >1 allows a single harmonic to be measured. With the factor 1 the fundamental can be selected.

Specified range: 1 to 20

**Note:** *The factor does not affect the notch filter frequency. With GEN TRACK selected, the notch filter is set exactly to the generator frequency without considering the "factor" so that a wider dynamic range can be obtained through the suppression of the fundamental irrespective of the measurement task.*

**Sweep Mode**

Displayed only with **FREQ MODE** → **GEN TRACK** in the **ANLG 22 kHz** and **DIG 48 kHz** analyzers.

This menu item is used to increase the speed of frequency sweeps using the built-in universal generator.

**UPL-B29:** *In the high rate mode, the sweep can be operated at normal speed only; the menu item Sweep Mode is therefore not offered.*

To increase the sweep speed the following **generator conditions** must be fulfilled:

- Function                   SINE
- Low distortion           OFF
- Sweep control           AUTO to
- X axis                     FREQ
- Z axis                     OFF

In addition, the following settings have to be made in the **ANALYZER panel:**

- Freq Mode                **GEN TRACK**
- Notch (Gain)            **OFF** (recommended)

**Description:**

The 1st sweep is always performed with the speed set under **NORMAL**. During this sweep the filter and generator parameters for the subsequent sweeps are learned and stored (learn mode).

As long as no new settings are made in the instrument, the **FAST** and **BLOCK** mode can use the learned parameters as from the 2nd sweep (play mode) so that setting times for the individual sweep points are considerable shortened.

If the start key is pressed or a instrument setting made, the (slower) learn mode is selected.

**Note:** *In the play mode, measured values are not indicated in the result display for reasons of speed.*

**NORMAL**

Normal sweep without additional speed optimization; may be used for any kind of sweep. This setting is used internally whenever one of the conditions for optimized sweep synchronization is not met, e.g. in the learn mode (see below).

**FAST**

Speed-optimized sweep without any operational restrictions. Measured values are not indicated for reason of speed.

**BLOCK**

Further speed optimization of sweep but in this case the instrument cannot be operated during the sweep. If one or several keys are pressed, the sweep is terminated and the **FAST** mode is selected where the functions of the pressed keys are executed. Measured values are not indicated for reasons of speed; traces are displayed upon completion of the sweep.

**Notch (Gain)**

(see 2.6.5.1 Common Parameters of Analyzer Functions)  
 An analog notch can be switched on additionally in the analog analyzers to improve the stopband attenuation.

The notch frequency is coupled directly to the band center frequency of the selective filter, i.e., it is selected via the menu FREQ MODE.

**Filter**

(see 2.7 Analyzer Filters (FILTER Panel))  
 In addition to the selective filter and the analog notch, another (digital) filter can be selected.

**Application:** Highpass filter for DC suppression.

**Funct Sett**

(see 2.6.5.1 Common Parameters of Analyzer Functions)

**SPEAKER**

(see 2.6.6 Headphone/Speaker Output)

**Specified range for the bandpass center frequency:**

The minimum and maximum possible center frequency is determined by the instrument selected and the bandwidth specified and is displayed in the operator guidance line.

Analyzer	f with bandwidth 1%	f with bandwidth 3%	f <sub>c</sub> with bandwidth 1/3 OCT	f with bandwidth 1/12 OCT	f <sub>c</sub> with bandwidth FIX:
ANLG 22 kHz	10 Hz to 21.83 kHz	10 Hz to 21.61 kHz	10 Hz to 19.54 kHz	10 Hz to 21.31 kHz	$5,05 \text{ Hz} + \frac{bw_{fix}}{2} \dots f_{N1} - \frac{bw_{fix}}{2}$
ANLG 110 kHz	64 Hz to 119.4 kHz	64 Hz to 118.2 kHz	64 Hz to 106.2 kHz	64 Hz to 116.6 kHz	$35,91 \text{ Hz} + \frac{bw_{fix}}{2} \dots f_{N2} - \frac{bw_{fix}}{2}$
DIGITAL	$f_{cmin} \dots \frac{f_N}{1,005}$	$f_{cmin} \dots \frac{f_N}{1,015}$	$f_{cmin} \dots \frac{f_N}{1,12246}$	$f_{cmin} \dots \frac{f_N}{1,0293}$	Sample freq. 0.1052E-3 + $\frac{bw_{fix}}{2} \dots f_{N-} - \frac{bw_{fix}}{2}$

- f<sub>c</sub> = Bandpass center frequency | f<sub>N1</sub>=21.94 kHz
- f<sub>cmin</sub> =  $\frac{\text{Int. sample freq.}}{4800}$  (minimum center frequency) | f<sub>N2</sub>=125 kHz
- f<sub>N</sub> = Int. sample freq. \*  $\frac{117}{256}$  (useful frequency)
- bw<sub>fix</sub> = bandwidth entered in numerical form

**Notes on aural monitoring of residual signal:**

Aural monitoring of the residual signal with the RMS selective measurement switched on is possible with the frequency-controlled universal generator (Low Dist = OFF), with setting FREQ MODE = GEN TRACK and the narrow bandstop filter Bandwidth = BS 1%. When the generator frequency is varied, the fundamental is suppressed by the bandstop filter.

If the low-distortion generator is used (Low Dist = ON), which offers a purer spectrum but not quite the frequency accuracy of the universal generator, the generator frequency may be slightly outside the range of the BS 1% bandstop filter. Thus the fundamental is not completely suppressed.

**Remedy:**

Select a wide bandstop filter (BS 3%, BS 1/3 OCT, 1/12 OCT) or set `FREQ MODE = FIX` with the desired center frequency for the RMS selective measurement and vary the frequency of the low-distortion generator in the GENERATOR panel by a few Hz to adjust the generator frequency exactly to the bandwidth of the bandstop filter.

To be able to continuously monitor the residual signal, a frequency measurement must not be selected in the ANALYZER panel, as for a frequency measurement all filters in the UPL have to be switched off for a brief period of time, i.e. also the RMS-selective bandpass or bandstop filter:

`FREQ/PHASE = OFF`,

`FREQ MODE not FREQ CH1 | FREQ CH2`.

### 2.6.5.4 PEAK, Q-PEAK (Peak and Quasi-peak Weighting incl. S/N)

Available in the analyzers ANLG 22 kHz and DIGITAL.

#### PEAK measurement

Peak value detector follows the waveform without delay.

#### Quasi-PEAK measurement

Peak value detection with subsequent and defined rising and falling times. This measurement is used for interference voltage measurements to CCIR 468-4 and DIN 45405.

In the peak and quasi-peak measurement, the maximum peak value of the input signal is determined and displayed within the monitoring interval selected under menu time "Intv Time". Subsequently, the peak value memory is cleared and the next peak value is searched for. The principle of operation is comparable to that of a maximum pointer instrument.

#### As to the measurement:

- With the use of the analog analyzer an internal DC offset is also part of the measured value. The DC offset can be minimized using the CALIBRAT function in the OPTION panel.
- When applying a squarewave signal, it is bandlimited by the upper limit of the selected analyzer, leading to overshoots at the edges (Gibb's phenomenon). The overshoots are also measured during peak weighting, which may lead to a measured value exceeding the input peak. Particularly in the digital range, full-scale values > 1 may be measured (see 2.4 Units).

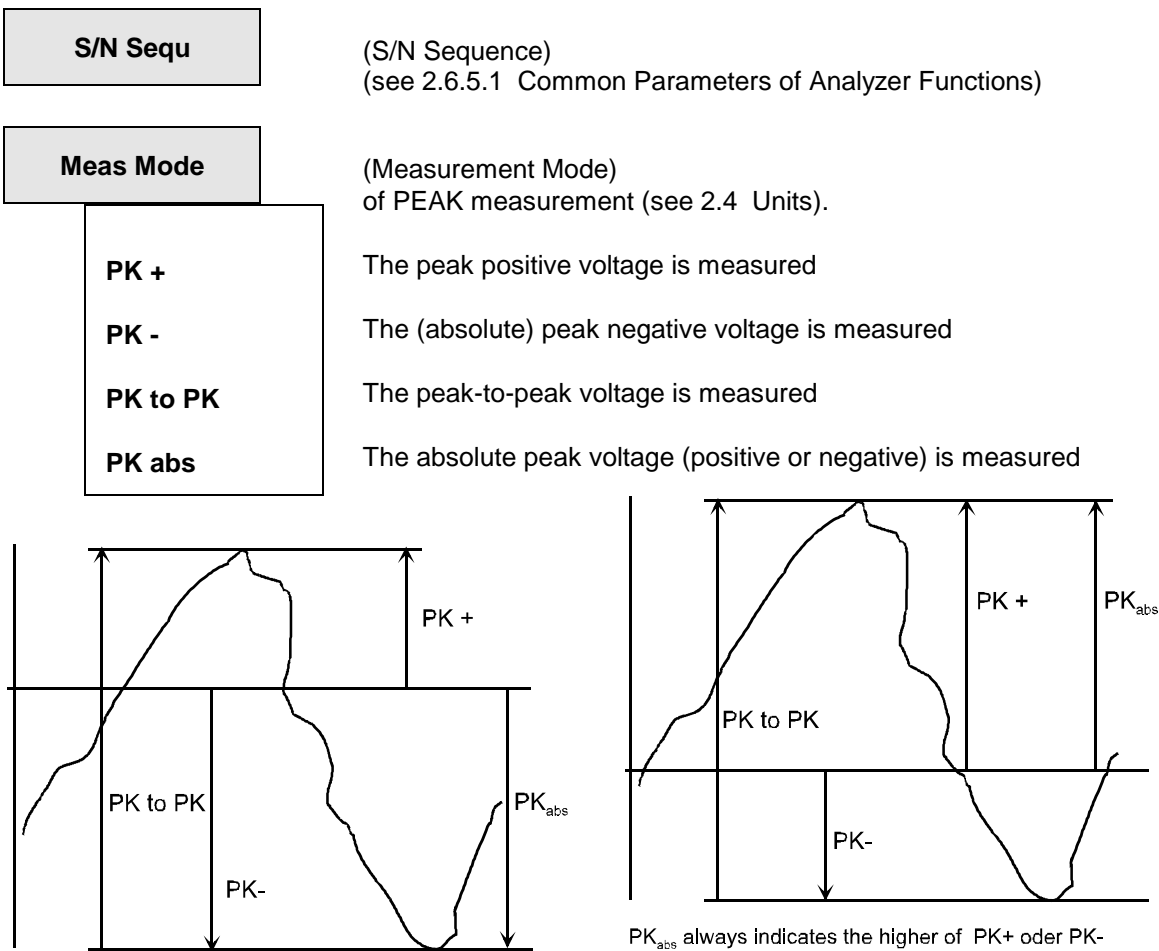

Fig. 2-22 Signal with the measurement modes

Intv Time	<p>(Interval Time) Monitoring interval for peak value detection Selection depends on the type of input signal and measurement sphere. Universal specifications cannot be made.</p>
<p><b>FIX 50 MS</b></p> <p><b>FIX 200 MS</b></p> <p><b>FIX 1000 MS</b></p> <p><b>FIX 3 SEC</b></p> <p><b>VALUE</b></p>	<p>50 ms PEAK only</p> <p>200 ms PEAK only</p> <p>1000 ms PEAK only</p> <p>3000 ms PEAK only</p> <p>Numerical entry. Range of value: 20 ms to 100 s, Units: s   ms   <math>\mu</math>s   min</p> <p><b>Notes on quasi-peak measurement:</b> <i>In order to obtain settled measured values, the measuring time should not drop below 3 s with triggered measurements and sweeps.</i></p>
Unit Ch1/2	(see 2.6.5.1 Common Parameters of Analyzer Functions)
Reference	(see 2.6.5.1 Common Parameters of Analyzer Functions)
Notch (Gain)	<p>quasi peak only (see 2.6.5.1 Common Parameters of Analyzer Functions)</p>
Filter	<p>(see 2.7 Analyzer Filters (FILTER Panel) Maximum 3 filters can be selected.</p> <p><b>UPL-B29:</b> <i>No filters can be switched on in the high rate mode.</i></p>
Fnct Sett1	(see 2.6.5.1 Common Parameters of Analyzer Functions)
SPEAKER	(see 2.6.6 Headphone/Speaker Output)

2.6.5.5 DC

Principle of measurement

DC voltages can be measured from 0 to ±30 V. The DC reference point is the connecting point 3 of the XLR female connectors (see 2.6.2). For selecting the measurement range for DC measurements, see 2.6.2, Range Table.

During a DC measurement, overloading of the measurement path caused by a superposed AC voltage causes a less sensitive range to be automatically set, which however means less measuring accuracy.

**Meas Time**

**FIX 200 MS**  
**VALUE**

If the DC voltage is superposed by an AC voltage, specifying the Meas Time as integration time relative to the signal period of the AC voltage has different effects:

Meas Time is an integer multiple of signal period:  
An integration effect results. The AC voltage is **not** included as part of the DC measurement result. Steady display!

Meas Time larger than, yet no integer multiple of signal period:  
As above, yet beats occur in the display

Meas Time smaller than signal period:  
No integration effect. The AC voltage is included as part of the DC measurement result. The DC measurement result follows the course of the AC voltage.

Measuring time 200 ms

Numerical entry.  
Specified range: 100 µs to 1.5 s  
Units: s | ms | µs | min

**Unit Ch1/2**

(see 2.6.5.1 Common Parameters of Analyzer Functions)

**Reference**

(see 2.6.5.1 Common Parameters of Analyzer Functions)

**Funct Settl**

(see 2.6.5.1 Common Parameters of Analyzer Functions)

**SPEAKER**

(see 2.6.6 Headphone/Speaker Output)

### 2.6.5.6 THD Measurement

Available in all analyzers.

For distortion measurements, apply an extremely pure sinewave signal to the device under test. Select the signal frequency such that the significant components of the distortion spectrum are still below the upper range limit (see 2.6.1, 2.6.2, 2.6.3) of the selected ANALYZER instrument.

A signal not meeting the requirements leads to a SHOW I/O message (see 2.3.5):

The signal has no zero crossings and is not suitable for distortion measurements:

*"Can't find zero crossing in Signal"*

With the signal function SINE (see 2.5.4.3) in combination with the low-distortion generator (UPL-B1 option), the generator in the UPL offers a sinewave signal meeting the high demands on its spectral purity.

#### Principle of measurement

The UPL offers the possibility of distortion measurements over single harmonics or combinations thereof (d2 to d9), the amplitudes of the single harmonics being selectively measured and their square sum put in relation to the total rms value. As against the THD+N measurement (see 2.6.5.7 THD+N/SINAD measurement), broadband noise is not considered in the THD measurement due to the selective harmonics measurement.

$$U_{\text{THD}}[\text{dB}] = 20 \times \log \frac{\sqrt{U_{d2}^2 + \dots + U_{d9}^2}}{\text{total rms value}}$$

$\sqrt{U_{d2}^2 + \dots + U_{d9}^2}$  : square sum of selected harmonics

#### Display of the measurement result:

Apart from displaying the THD in the result display, an additional graphical (histogram) or numerical display of the fundamental and the individual harmonics can be switched on. This is effected by selection of OPERATION SPECTRUM or SPECTR LIST in the DISPLAY panel. All harmonics in the frequency range are indicated in the histogram. The selected harmonics which are contained in the result are marked by wide bars, the other ones by narrow bars, so that they can be distinguished.

**Note:** *If the fundamentals applied to the two measuring inputs have different frequencies, the frequencies indicated in the graphics refer to the channel which is displayed in trace A.*



**Meas Mode**

- SELECT di**
- All even di**
- All odd di**
- All di**
- LEV SEL di**
- LEV even di**
- LEV odd di**
- LEV all di**

(Measurement Mode)

Select the harmonics to be measured and the way of display. The harmonics are then displayed above the measured value window. "THD 2-4-6-8", for example, means that the 2nd, 4th, 6th and 8th harmonics are measured.

Any combination of harmonic distortions d2 to d9. The measurement result is the root from the square sum of the selected harmonic distortion **referred to the total RMS value**. Display in % or dB.

Like SELECT di, all **even** harmonics distortions (d2, d4, d6, d8) being selected.

Like SELECT di, all **odd** harmonic distortions (d3, d5, d7, d9) being selected.

Like SELECT di, **all** harmonic distortions (d2 to d9) being selected.

Any combination of harmonic distortions d2 to d9. The measurement result is the root from the square sum of the selected harmonic distortion, display as **RMS value** (with any level unit).

Like LEV SEL di, all **even** harmonics distortions (d2, d4, d6, d8) being selected.

Like LEV SEL di, all **odd** harmonic distortions (d3, d5, d7, d9) being selected.

Like LEV SEL di, **all** harmonic distortions (d2 to d9) being selected.

**di 2 4 6 8**

- √ d2
- √ d3
- √ d4
- √ d5
- √ d6
- √ d7
- √ d8
- √ d9

is displayed only, if either SELECT di or LEV SEL di has been selected with Meas Mode.

Upon selection of the desired harmonic distortions using the ↑ and ↓ keys, the harmonic distortion measurement can be selected (√) or disabled by pressing the SELECT key.

**Dyn Mode**

(Dynamic Mode) only with analog analyzers, determines the possible dynamic of the measurement result and thus the measurement rate.

**FAST**

A fast measurement with less dynamic is performed.

**PRECISION**

The measurement is performed with higher dynamic and with the analog notch filter cut in. The notch filter is suitable for measurements up to 22.5 kHz - i.e. there are no restrictions in the ANLG 22-kHz instrument. Signals with a fundamental  $\leq 22.5$  kHz can be measured in the ANLG 110-kHz instrument. Signals with a fundamental  $> 22.5$  kHz cause the error message "Frequency exceeds notch range" to be output.

The measuring time is longer in the PRECISION mode.

**Unit**

(see 2.6.5.1 Common Parameters of Analyzer Functions)

**Reference**

(See 2.6.5.1 Common Parameters of Analyzer Functions) only available in level measurement modes (LEV...).

This value may be entered manually if desired. Otherwise, the current RMS value will be automatically entered, if the reference value of INPUT DISP RMS is stored with the STORE (or STORE CH1 or STORE CH2) function.

**Fundamental**

Specifies how the fundamental is to be determined.

- AUTO**
- VALUE**
- GEN TRACK**

UPL automatically determines the fundamental (during a THD measurement).

AUTO should always be used when the signal is derived from a low-distortion generator or an external generator and the signal has not an extremely high harmonic content.

Numerical entry of fundamental

Specified range:

ANLG 22 kHz: 6 Hz to 21.9 kHz

ANLG 110 kHz: 38 Hz to 125 kHz

DIGITAL: sample frequency/8192 to useful bandwidth

Useful bandwidth = sample frequency \* 117/256

VALUE should be preferred for signals with a high harmonic content derived from an external generator.

UPL takes the fundamental from the frequency setting of the generator. This improves the setting accuracy for signals with a high harmonic content.

GEN TRACK should be used when the signal is derived from the internal universal generator.

**Note:** When the internal low-distortion generator is used, the generator frequency is accurately measured and the fundamental corrected, if required. Thus the measurement result is not influenced by the frequency inaccuracy of the generator (e.g. temperature drift).

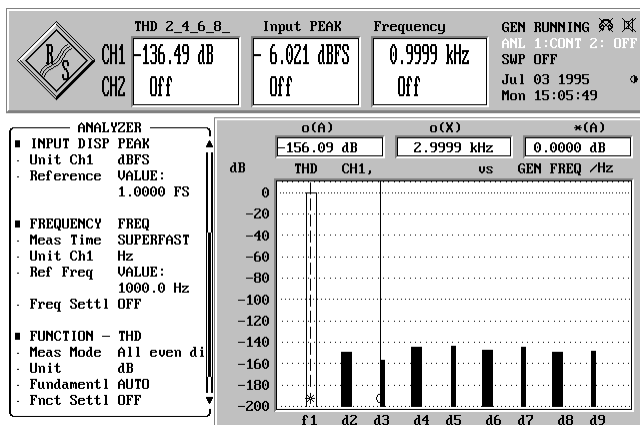

Graphical presentation of THD measurement results in the form of a histogram see 2.10.1 and 2.10.2

**Funct Sett1**

(see 2.6.5.1 Common Parameters of Analyzer Functions)

**SPEAKER**

(see 2.6.6 Headphone/Speaker Output)

### 2.6.5.7 THD+N/SINAD Measurement (Total Harmonic Distortion+ Noise)

Available in all analyzers.

For THD or SINAD measurements, apply a highly pure sinewave signal to the device under test. Select the signal frequency such that the significant components of the THD spectrum are still below the upper measurement limit (see 2.6.1, 2.6.2, 2.6.3) of the used ANALYZER instrument.

If the signal offered does not meet the requirements, a SHOW I/O message is output (see 2.3.5):

- In the frequency range, the fundamental wave cannot be found:

*"Can't find fundamental"*

- The frequency of the found fundamental wave is less than the lower limit value (for its calculation, see below, Fundamental VALUE):

*"Fundamental too low"*

With the signal function SINE (see 2.5.4.3) in combination with the low-distortion generator (UPL-B1 option), the generator in the UPL offers a sinewave signal meeting the high demands on its spectral purity.

#### Principle of measurement

The fundamental is filtered out and the remaining energy consisting of harmonics and broadband noise within the band limits specified under "FrqLim Low" and "FrqLim Upp" is calculated in one or several FFT procedures. The user can select the size of the *first* FFT for starting the calculation,

- implicitly by selecting measurement time (with post FFT switched off)
- explicitly by selecting FFT size (with post FFT switched on).

A compromise has to be made between measurement speed and measurement accuracy. If the FFT size is not sufficient to measure the fundamental of the measurement signal, the FFT size and if required the zoom factor can be increased in steps.

The energy of the noise and harmonics can either be displayed as an rms value or related to the total rms value, the total rms value being bandlimited to "FrqLim Upp". The selection is made under the menu item "Meas Mode". Depending on the selected measurement mode, different units are used:

- V or FS for rms display
- % or dB for the ratio display

In the measurement modes NOISE and LEVEL NOISE, all harmonics are filtered out in addition to the fundamental. With every harmonic also the noise energy of the respective sideband is filtered out. In the case of very low frequencies - and theoretically a great number of harmonics - a considerable amount of the noise energy is thus lost. These measurement modes should therefore only be used for higher frequencies ( $> 100 * \text{FFT resolution}$ ) and large FFT size.

#### Measurement limits

The lower frequency limit for the signal is 10 Hz (or 20 Hz in the ANLG 110 kHz). The frequency of the fundamental must be limited at the upper end so that the harmonic to be measured is still below the limit frequency of the analyzer used or below the selected "FrqLim Upp". For measurements in the dynamic mode PRECISION, the fundamental (in the ANLG 110 kHz analyzer) should not be higher than 22.5 kHz (upper frequency limit of built-in analog notch filter).

For noise measurements (in the measurement modes NOISE and LEVEL NOISE, with harmonics not being taken into account) the fundamental must be at least 36 times the minimum resolution (displayed under Post FFT). In the ANLG 22-kHz analyzer and at a sampling rate of 48 kHz in the digital analyzer, a lower limit of 105.6875 Hz is obtained, in the ANLG 110 kHz analyzer 675 Hz.

THDN Post FFT is only possible if the fundamental of the measurement signal is by a multiple (depending on the selected analyzer) above the resolution selected under Post FFT (see FFT size). To reduce the resolution and thus the lower frequency limit, the FFT size may have to be increased.

**Measurement speed**

The measurement speed depends on the (selected) FFT size and the required dynamic measurement range.

The required FFT size is obtained from the frequency of the signal to be measured and the desired accuracy. The wider the FFT, the finer the frequency resolution and the lower the lower frequency limit. Consequently, a wide FFT has to be used for low frequencies or high accuracy requirements so that a longer measurement time has to be accepted.

For measuring particularly low-distortion signals, the measurement range can be extended by selecting the Precision mode with the result that the measurement time is doubled.

To obtain the highest possible measurement speed, two parameters can be optimized:

- Select smallest FFT size or adapt the FFT size to the fundamental of the measurement signal. The FFT size should be large enough so that the fundamental to be measured is at least 10 times greater (8.5 times in the ANLG 110, 12 times in the digital analyzer) as the resolution displayed under Post FFT. Only then can the total signal be measured with one single FFT. If the UPL generator is used as a signal source, *Fundamental GEN TRACK* and *FFT Size 512 ("Meas Time SUPERFAST")* should be selected.
- Select *Dynamic Mode FAST* if the signal does not require the full dynamic measurement range.

**Display of measurement result:**

In addition to the total harmonic distortion (in the result display), its frequency spectrum can also be represented graphically or numerically as POST FFT. This is effected by selection of OPERATION SPECTRUM or SPECTR LIST in the DISPLAY panel.

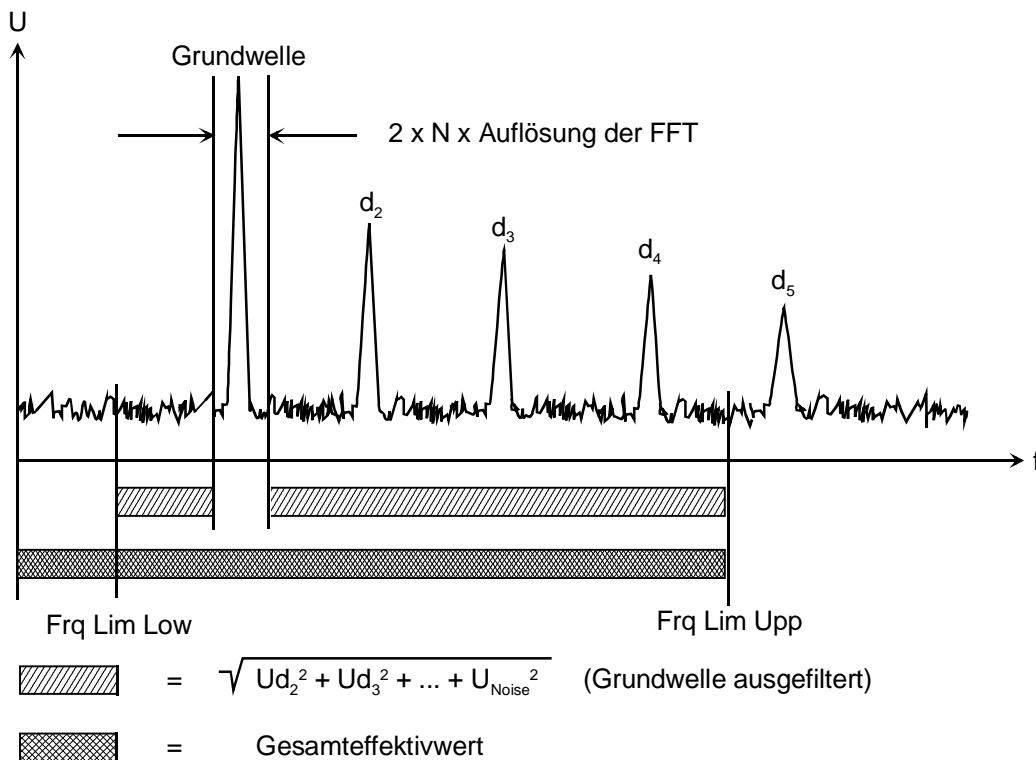

Fig. 2-23

N = 12 for digital analyzer  
 10 for ANLG 22 kHz  
 8.5 for ANLG 110 kHz

$$U_{\text{THD+N}}[\text{dB}] = 20 \cdot \log \frac{\sqrt{U_{d2}^2 + U_{d3}^2 + \dots + U_{\text{noise}}^2}}{\text{total rms value}}$$

THD+N measurements provide negative dB-values, SINAD measurements result in positive dB-values. The magnitudes of the values are identical.

$$\sqrt{U_{d2}^2 + U_{d3}^2 + \dots + U_{\text{noise}}^2} = \text{Square sum of all harmonic distortions+ noise within the frequency range specified under FrqLim Low and FrqLim Upp.}$$

**Meas Mode**

- THD+N
- SINAD
- NOISE
- LEVEL THDN
- LEVEL NOISE

(Measurement mode)  
 Selection of the measurement and display modes. The measurement mode selected is displayed above the measured value window.

The THD including noise is measured, the result is the root from the square sum of the selected harmonic and the noise voltage, **referred to the total RMS value**, display in % or dB.

Like THD+N, however, displayed as reciprocal value; display only (positive) dB.

The noise is measured, only; the noise voltage **referred to the total RMS value** is obtained as result, display in % or dB.

The THD including noise is measured, the result is the root from the square sum of the selected harmonic and the noise voltage, display of the rms value (in any level unit).

The noise is measured, only; the noise is obtained as result, display of the rms value in % or dB.

**Dyn Mode**

- FAST
- PRECISION

(Dynamic Mode) only in the analog analyzers  
 Determines the possible dynamic of the measurement result and thus the measurement rate.

A fast measurement with low dynamic is performed.

The measurement is performed with higher dynamic and with the analog notch filter cut in; the measuring time increases, correspondingly. The notch filter is laid out for measurements up to 22.5 kHz - i.e. there are no restrictions in the ANLG 22-kHz instrument. Signals with a fundamental ≤ 22.5 kHz can be measured in the ANLG 110-kHz instrument. Signals with a fundamental > 22.5 kHz cause the error message "Frequency exceeds notch range" to be output.

The measuring time is longer in the PRECISION mode.

**Rejection**

- NARROW**
- WIDE**

Displayed only in the analog instruments with the Dyn Mode FAST.

The fundamental is suppressed extremely narrowband. Thus, interference components can be recognized which are very close to the carrier.

To suppress the fundamental, a notch filter is used with a characteristic which was in the past commonly used in analog measuring instruments. The measured values are improved due to the broadband filtering, since harmonic components close to the carrier are also suppressed. This mode should be used if the measurement results are to be comparable to those of analog instruments.

**Meas Time**

- SLOW**
- FAST**
- SUPERFAST**

(Measurement time)

The measurement time is used to adapt the measurement speed to the required accuracy. To obtain a higher measurement speed the (initial) FFT size is reduced.

Measurements are performed with the greatest FFT size (8k zoom FFT). Additional FFTs (with a higher zoom factor) are only required for extremely low frequencies. This setting should be selected in particular when only the noise (NOISE or LEVEL NOISE) is measured so that harmonics are suppressed with a bandwidth as narrow as possible.

The initial FFT is measured with reduced FFT size (2 k). With low frequencies, additional FFTs (with more points and a higher zoom factor) are required.

The initial FFT is measured with the smallest FFT size (0.5 k). Additional FFTs (with more points and a higher zoom factor) may be required. This setting should only be selected if the measurement result need not be too accurate and the frequency of the signal to be measured is not very low.

**Note:** *With post-FFT switched on, the FFT size can be set as required irrespective of the settings made here, i.e. the selected measurement speed is ignored.*

**Unit**

(see 2.6.5.1 Common Parameters of Analyzer Functions)

**Reference**

(See 2.6.5.1 Common Parameters of Analyzer Functions) only available in level measurement modes (LEV...).

This value may be entered manually if desired. Otherwise, the current RMS value will be automatically entered, if the reference value of INPUT DISP RMS is stored with the STORE (or STORE CH1 or STORE CH2) function.

**Fundamental**

Determines how to obtain the fundamental frequency.

**AUTO**

UPL determines the fundamental frequency automatically (while the THD+N measurement is being performed)

**VALUE**

Numerical entry of fundamental frequency.

Specified range:

ANLG 22 kHz: 10.0 Hz to 21.9 kHz

ANLG 110 kHz: 20 Hz to 120 kHz

DIGITAL: 12 \* sample freq. /8 \* 8192 to sample freq. \* 117/256

The setting VALUE should preferably be used for signals with a high harmonic content when an external generator is used as a signal source.

**GEN TRACK**

UPL takes the fundamental from the frequency setting of the generator. This increases the setting accuracy for signals with high harmonic content and increases the measurement speed.

If the frequency of a fundamental cannot be measured with the set FFT size, the FFT size is increased such that the measurement can be performed with a single FFT (or 2 FFTs in the precision mode). Thus the highest possible measurement speed can be obtained for any generator frequency with the setting FFT Size 512.

Setting GEN TRACK is to be used when the signal is derived from the internal generator.

**Note:** *When the internal low-distortion generator is used, the generator frequency is accurately measured in the measurement modes NOISE or LEVEL NOISE and the dynamic mode PRECISION and the fundamental is corrected, if required. Thus the measurement result is not influenced by the frequency inaccuracy of the generator (e.g. temperature drift). This does not affect the measurement speed, however.*



**Filter**

- OFF
- A weighting
- C MESSAGE
- CCITT
- CCIR wtd
- CCIR unwtd
- DEEM 50/15
- DEEMPH 50
- DEEMPH 75
- DEEMPH J.17
- RUMBLE WTD
- RUMBLE UNW
- DC NOISE HP
- CCIR ARM
- IEC TUNER

The THD+N measurement result can be weighted using one of 14 filters (see 2.7.1). User definable filters are available, too.

CCIR unwtd is not available in the ANLG 110-kHz instrument.

**FrqLim Low**

Lower band limit of THD+N / SINAD measurement function. This limit does *not* influence calculation of the total RMS value.

Specified range:

ANLG 22 kHz: 10.0 Hz to 21.93 kHz

ANLG 110 kHz: 20.0 Hz to (120 kHz - 62.5 Hz)

DIGITAL: sample freq./ (2 \* 8192) to (sample freq. \* 0.45294)

**FrqLim Upp**

Upper band limit of THD+N / SINAD measurement function

Specified range:

ANLG 22 kHz: (FrqLim Low + 8.79 Hz) to 21.94 kHz

ANLG 110 kHz: (FrqLim Low + 62.5 Hz) to 120 kHz

DIGITAL: (FrqLim Low + sample freq. / 5461.3) to sample freq. \* 117/256

**Note:** *If the fundamental of the measurement signal is above "FrqLim Upp", relative measurements (THDN, SINAD and NOISE) are not useful because the energy of the fundamental has been filtered out in the reference signal. In this case an error message is output.*

Only harmonic distortions and noise components within the band limits are used in the calculation.

Only frequencies *below FrqLim Upp* are considered in the calculation of the total RMS value.

**Funct Sett1**

(see 2.6.5.1 Common Parameters of Analyzer Functions)

## POST FFT

OFF

ON

(see 2.6.5.1 Common Parameters of Analyzer Functions)

There is **no** post-processing of measuring data for POST FFT, the measurement can thus be terminated faster.

After obtaining the result of the THD+N measurement, the measured data are prepared for **POST FFT display**. The display can be selected in the DISPLAY panel. Only FFT Size of the following five FFT setting parameters can be modified, all others are displayed.

**Note:** *If the selected FFT size is too small, the POST FFT cannot be displayed.*

## FFT Size

512  
1024  
2048  
4096  
8192

FFT size used for THDN calculation and post-FFT display, adjustable between 512 and 8192 in steps of 2.

A larger FFT size (i.e. more calculated points) yields a finer frequency resolution and thus a lower frequency limit and higher accuracy but longer measurement times.

The FFT size selected determines the display of the post FFT and the original zoom FFT used for THDN calculation. If the FFT size is not sufficient to resolve the fundamental, the following results are obtained has the following consequences:

- The post FFT cannot be displayed; an error message is indicated in the graphics display.
- Additional FFTs with an increased number of points are automatically calculated; the measurement time is extended accordingly.

To be able to perform a *Post* FFT, the fundamental must be above the displayed resolution (see below) by a defined factor. This factor is as follows:

- 12 for (LEVEL) THDN and SINAD in the digital analyzer,
- 10 for (LEVEL) THDN and SINAD in the ANLG 22 kHz analyzer,
- 8,5 for (LEVEL) THDN and SINAD in the ANLG 110 kHz analyzer,
- 36 for all (LEVEL) NOISE measurements.

If required, the FFT size has to be increased or the ANLG 22 kHz instrument has to be selected.

To avoid additional FFTs (because the FFT size is too small) without having to switch to a larger and thus slower FFT, "Fundamental GEN TRACK" should be selected when the internal generator is used. With this setting the fundamental is known before the 1st FFT so that the calculation can be started with the smallest possible FFT ( $\geq$  FFT size).

**Window**

Always RIFE VINC 2 (analog) or RIFE VINC 3 (digital)

**Note:** For special applications the FFT window may be selected arbitrarily with the THD+N measurement using the command line parameter "-tthdnwin"; the "-tthdn" parameter which can be used up to software version 2.02 has no function any more with 2.03.

**Start**

Display value, not identical with FrqLim Low

**Stop**

Display value, (useful bandwidth), not identical with FrqLim High

**Resolution**

The display value determines the lower limit frequency for the measurement.

**Equalizer**

Activation/deactivation of an equalizer table consisting of frequency information and associated voltage gain factors.

The frequency response of a transmission link can be equalized, for example, and the measurement point can be transformed to a different reference point.

The FFT bins of the spectrum recorded are multiplied by a frequency-dependent equalizer factor which may be calculated by interpolating the two adjacent frequency reference points of the equalizer table. The FFT spectrum thus equalized can be used as a basis for the calculation of the THD+N or level value and can be displayed.

The equalization of the FFT spectrum is an interesting alternative to filtering the input signal since the equalizer file can be easily generated from the frequency response to be equalized (see 2.9.1.2) and does not have to be available as coefficient or pole/zero file.

**Typical application for acoustic measurements (e.g. mobile phones):**  
*compensation of transfer function ERP (ear reference point) to DRP (drum reference point) for measurements on artificial ears of type 3.2 or higher. The THD+N measurement of the sound waves by the microphone applied to the "eardrum" can thus be referred to the required measurement point (at the auricle).*

**ON**

**OFF**

The equalizer is switched on. The menu item 'Equal. file' is activated, i.e. the indicated file is loaded. The THD+N value is calculated from the equalized FFT spectrum.

The equalizer is switched off. The THD+N value is calculated from the original FFT spectrum.

**Equal. file**

(Equalizer file) only if equalizer → ON

Menu item for entering the name of the equalizer file. The file is opened and loaded into an internal buffer.

If the name entered is not valid (drive not ready, file not found, invalid format etc), an error message is displayed and "not found" is entered into the menu line.

For entering file names see 2.3.2.5

For generating an equalizer file see 2.9.1.2 Loading and Storing of Series of Measured Values and Block/List Data ("Store → EQUALIZATN").

**SPEAKER**

(see 2.6.5.1 Common Parameters of Analyzer Functions)

Aural monitoring of the residual THD+N signal is described in section 2.6.6 Headphone/Speaker Output; Example of application: Monitoring the distortion component of a signal.

**UPL-B29:** Aural monitoring of the residual signal is not possible in the high rate mode.

**2.6.5.8 MOD DIST (Modulation Distortion)**

Available in all analyzers.

For modulation distortion measurements, apply a frequency mixture consisting of a low-frequency interfering sinewave signal (e.g. 60 Hz) and a high-frequency useful sinewave signal (e.g. 7 kHz) to the device under test. The amplitude of the interfering signal should be equal or higher than that of the useful signal. According to DIN IEC 268 Part 3, a peak amplitude ratio of interfering : useful signal = 4 : 1 should preferably be selected.

When the signal offered does not meet the requirements, a SHOW I/O message (see 2.5.3) is output:

- Useful signal is not in the frequency range from 2 kHz to 110 kHz:  
*"Cannot find high tone in the range from 2 to 110 kHz."*
- Interfering signal is not in the frequency range from 0 Hz to 1100 Hz:  
*"Cannot find low tone in the range from 0 to 1100 Hz."*

With the signal function MOD DIST (see 2.5.4.7), the UPL generator offers by the above frequency mixture, allowing the frequencies and amplitude ratio of interfering and useful signal as well as the level to be specified. Total level and useful frequency can be swept.

**Principle of measurement**

Unaffected by noise due to selective measurement, the UPL measures the intermodulation products of 2nd and 3rd order in line with DIN IEC 268 Part 3 and does the square sum of the intermodulation products. (Contrary to the DIN IEC 268 Part 3 Recommendation, the total modulation distortion is measured to permit comparisons with the hitherto commonly used SMPTE measurement procedures).

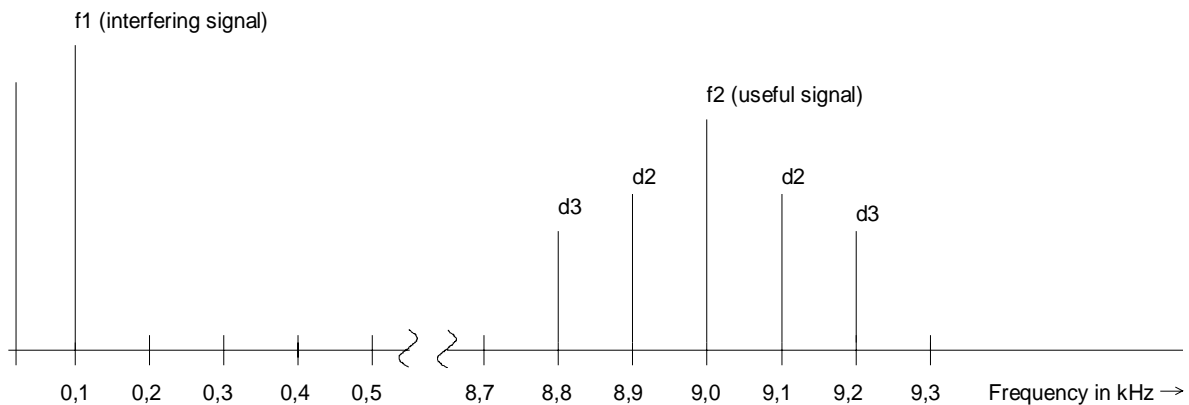

d2 = Intermodulation product of 2nd order  
 d3 = Intermodulation product of 3rd order

Fig. 2-24

Modulation distortion of 2nd order

$$dm2 = \frac{|U_{(f1+f2)}| + |U_{(f2-f1)}|}{U_{(f2)}}$$

Modulation distortion of 3rd order

$$dm3 = \frac{|U_{(f2-2f1)}| + |U_{(f2+2f1)}|}{U_{(f2)}}$$

Square sum:

$$dm(2+3) = \sqrt{dm2^2 + dm3^2}$$

$$MOD\ DIST\ [dB] = 20 * \lg (dm(2+3))$$

**Display of the measurement result:**

In addition to displaying the total intermodulation distortion in the result display, an additional graphical (histogram) or numerical display of the useful frequency and the signal frequency and of the individual intermodulation products can be switched on. This is effected by selection of OPERATION SPECTRUM or SPECTR LIST in the DISPLAY panel.

**Note:** If the intermodulation signals applied to the two measuring inputs have different frequencies, the frequencies indicated in the graphics refer to the channel which is displayed in trace A.

<b>Dyn Mode</b>	(Dynamic Mode), with analog analyzers, only. Determines the possible dynamic of the measurement result and thus the measurement rate.
<b>FAST</b> <b>PRECISION</b>	A fast measurement with less dynamic is performed.  If the measured value is better than 55 dB (analog 22 kHz) or 40 dB (analog 110 kHz), the measurement is performed with higher dynamic range and analog notch filter cut in. The measuring time increases, correspondingly. If the intermodulation value of the signal drops below 50 to 55 dB, the measurement is performed in FAST mode.
<b>Unit</b>	(see 2.6.5.1 Common Parameters of Analyzer Functions)
<b>Funct Sett1</b>	(see 2.6.5.1 Common Parameters of Analyzer Functions)
<b>SPEAKER</b>	(see 2.6.5.1 Common Parameters of Analyzer Functions)

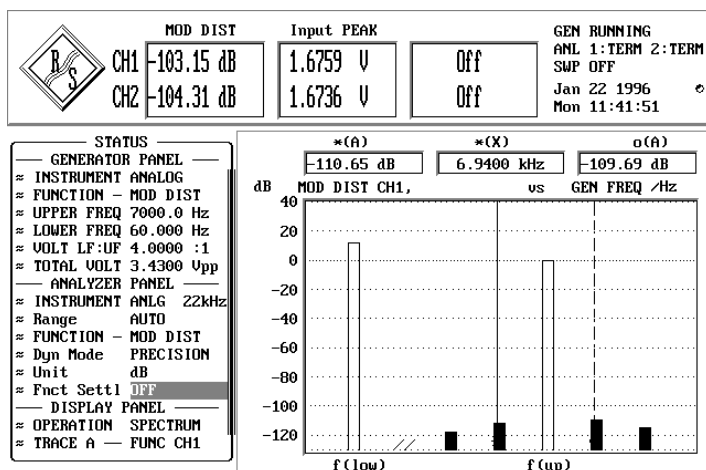

Graphical presentation of MOD DIST measurement results in the form of a histogram see 2.10.1 and 2.10.2

### 2.6.5.9 DFD (Difference Frequency Distortion)

Available in all analyzers.

To measure the difference frequency distortion of 2nd or 3rd order, apply a frequency mixture to the device under test. The frequency mixture is to consist of two sinewave signals of the same amplitude with, to DIN IEC 268 part 3, an arithmetic mean frequency out of the one-third octave band (5, 6.3, 8, 10, 12.5, 16, 20 kHz). A frequency offset of 80 Hz is to be selected, preferably.

Frequency limits for  $d_2$ - and  $d_3$ -measurements:

$2f_2 - f_1$  must still be within the frequency range of the instrument set (see 2.6.1).

When the signal offered does not meet the requirements, a SHOW I/O message is output (see 2.3.5):

- The frequency difference is higher than 1100 Hz:  
"Frequency difference of IMD tones seems to be too large; (> 2100.0 Hz)"
- The frequency difference is less than 70 Hz:  
"Frequency difference of IMD tones seems to be too small; (<70.0 Hz)"
- The levels of the two sinewave signals differ by more than 20 %:  
"Level of IMD tones seems to be too different; (more than 20 %)"

**Note:** A level check of IMD tones is **not** performed in the measurement modes to **IEC 118**. A DFD measurement can therefore be carried out even in the case of strongly distorted IMD signals (e.g. because of the frequency response of the DUT or the transmission path).

With the signal function DFD (see 2.5.4.8), the UPL generator offers the above frequency mixture. The mean frequency, frequency difference and total amplitude can be specified by the user.

#### Principle of measurement

With the Meas Mode  $d_2$  or  $d_3$  selected, the UPL measures selectively. Thus being unaffected by noise, the intermodulation products of 2nd or 3rd order are measured in accordance with DIN IEC 268 part 3.

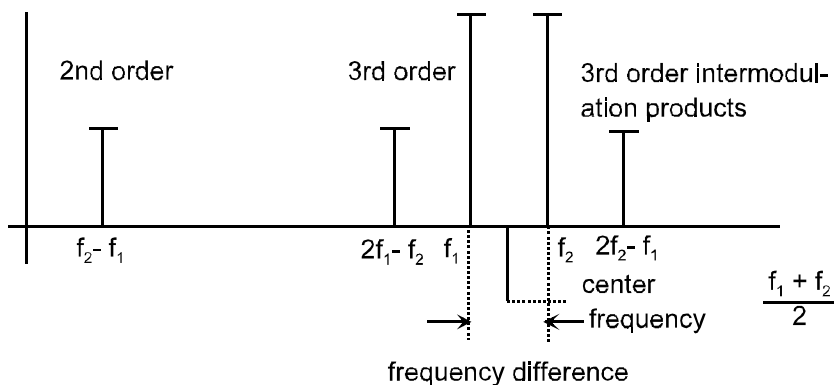

Fig. 2-25

Difference frequency distortion of 2nd order:

Difference frequency distortion of 3rd order:

$$d_2 [dB] = 20 \times \lg \frac{|U_{(f_2 - f_1)}|}{2 \times U_{(f_2)}} \qquad d_3 [dB] = 20 \times \lg \frac{|U_{(2f_2 - f_1)}| + |U_{(2f_1 - f_2)}|}{2 \times U_{(f_2)}} \qquad \text{to IEC 268}$$

$$d_2 [dB] = 20 \times \lg \frac{|U_{(f_2 - f_1)}|}{U_{(f_2)}} \qquad d_3 [dB] = 20 \times \lg \frac{|U_{(2f_1 - f_2)}|}{U_{(f_2)}} \qquad \text{to IEC 118}$$

**Display of measurement result:**

In addition to displaying the difference frequency distortion (d2 or d3) in the result display, an additional graphical (histogram) or numerical display of the center frequency and the difference frequency (according to the meas. mode selected) and of the individual intermodulation products can be switched on. This is effected by selection of OPERATION SPECTRUM or SPECTR LIST in the DISPLAY panel.

**Note:** *If the intermodulation signals applied to the two measuring inputs have different frequencies, the frequencies indicated in the graphics refer to the channel which is displayed in trace A.*

Meas Mode	
d2 (IEC 268)	Measurement and display of 2nd order intermodulation products referred to <i>twice</i> the "upper frequency" (to IEC 268).
d3 (IEC 268)	Measurement and display of 3rd order intermodulation products referred to <i>twice</i> the "upper frequency" (to IEC 268).
d2 (IEC 118)	Measurement and display of 2nd order intermodulation products referred to the "upper frequency" (to IEC 118).
d3 (IEC 118)	Measurement and display of 3rd order intermodulation products referred to the "upper frequency" (to IEC 118).

**Note:** *Measurements to IEC 118 are mainly used for hearing aids. Due to the different formulae, the d2 measurement to IEC 268 yields a result better by 6 dB.*

Dyn Mode	
FAST	A fast measurement with less dynamic is performed.
PRECISION	If the measured value is better than 50 dB, the measurement is made with higher dynamic. The measuring time increases, correspondingly. If the intermodulation value of the signal is below 50 dB, the measurement is performed in FAST mode.

Unit	(see 2.6.5.1 Common Parameters of Analyzer Functions)
Funct Sett1	(see 2.6.5.1 Common Parameters of Analyzer Functions)
SPEAKER	(see 2.6.5.1 Common Parameters of Analyzer Functions)



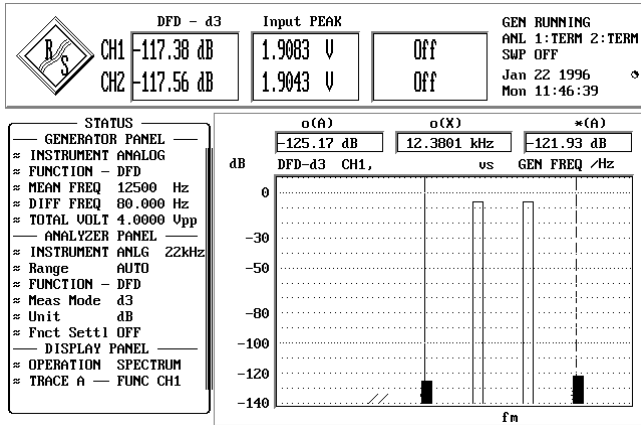

**2.6.5.10 Wow & Flutter**

Available only in the instruments ANLG 22 kHz and DIGITAL.

Measurement of the frequency deviation of a recording device (wow & flutter). To this end, a sine tone with fixed frequency (usually 3.15 kHz or 3.00 kHz) is reproduced by a reference sound carrier. During its reproduction, frequency errors occur because of cyclic variations. Frequency distortion is specified in percent of the carrier frequency. These deviations are determined using different weighting filters and methods depending on which standard is applied.

**Principle of measurement**

The input signal is limited symmetrically to the test frequency (3 kHz to NAB and JIS, 3.15 kHz to DIN) using a bandpass filter (passband width 1000 Hz, attenuation 80 dB, Bessel characteristic), and is subsequently subjected to FM demodulation. The demodulator output is sampled at 1/16 of the original sampling frequency and stored for POST FFT. A higher sampling rate is not useful because the signal is band-limited. Following a bandpass which can be cut in, the respective weighting is selected depending on the standard.

Standard	Set the standard applying to the measurement:
<p><b>DIN/IEC</b></p>	<p>Standards: DIN 45507 / IEC 386 / CCIR 409-2                      Reference frequency: 3150 Hz                      Weighting filters: weighted: bandpass, center frequency 4 Hz                      unweighted: highpass, 0.5 Hz                      Weighting method: quasi-peak,                      time constants: rising time: 30.8 ms,                      falling time: 606 ms</p>
<p><b>NAB</b></p>	<p>Standards: NAB Rec.                      Reference frequency: 3000 Hz                      Weighting filters: weighted: bandpass, center frequency 4 Hz                      unweighted: highpass, 0.5 Hz                      Weighting method: averaging the detected                      frequency error signal,                      time constant: 300 ms</p>
<p><b>JIS</b></p>	<p>Standards: Japan Industry Standard                      Reference frequency: 3000 Hz                      Weighting filters: weighted: bandpass, center frequency 4 Hz                      unweighted: highpass, 0.5 Hz                      Weighting method: rms weighting, integration time 2 sec</p>
<p><b>2 Sigma 5 s</b> <b>2 Sigma 10 s</b></p>	<p>The 2-sigma weighting to IEC 386/1988 is implemented in the UPL. Its purpose is to determine a threshold for the wow and flutter value at which 5 % of the measured values have a magnitude that is higher than this threshold, ensuring that sporadically occurring outliers do not affect the measurement result.                      The integration time is selectable: 5 or 10 seconds.</p>
Weighting	
<p><b>ON</b></p>	<p>The measurement is weighted using a weighting filter, bandpass 4 Hz.</p>
<p><b>OFF</b></p>	<p>Weighting filter off, highpass 0.5 Hz.                      Maximum weighting bandwidth in both cases: 200 Hz</p>

Frequency response of weighting filter (to DIN 45507, IEC 386, CCIR Rec. 409-2):

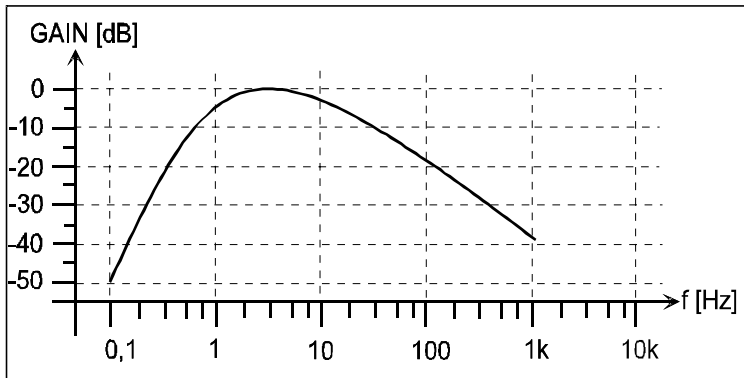

Fig. 2-26 Frequency response of weighting filter

**Unit**

(cf. 2.6.5.1 Common Parameters of Analyzer Functions)  
The W&F measurement result can be indicated in %, only.

**Funct Sett1**

(see 2.6.5.1 Common Parameters of Analyzer Functions)

**Post FFT**

**ON**

**OFF**

(see 2.6.5.1 Common Parameters of Analyzer Functions)

Display of the frequency spectrum of the data which have been FM-demodulated and weighted with the weighting filter. The wow and flutter measurement is aborted after about 2 seconds with POST FFT selected. The demodulated data are subsequently used for calculation of an FFT.

No POST FFT (thus no interruption of the measurement).

**FFT Size**

Enter FFT size (256 to 8192). (see 2.6.5.12 FFT).

**Window**

Select the window function; possible windows and their applications, see 2.6.5.12 FFT.

**Start**

Display of the frequency limits of the generated spectrum (no entry). Since the demodulator stage samples by the factor 16, the upper limit of the spectrum is

$$127/256 * \text{sampling rate} / 16$$

(For sampling rate, cf. 2.6.1 Selecting the Analyzer).

**Stop**

**Resolution**

Display of frequency resolution (no editing).

**SPEAKER**

(see 2.6.5.1 Common Parameters of Analyzer Functions)

### 2.6.5.11 POLARITY (Polarity Test)

Available in all analyzers.

The POLARITY measurement serves to check whether a device under test passes on an applied signal with the same polarity or with reversed polarity. To this end, set the POLARITY function on the generator (see 2.5.4.11) and apply the generator test signal (SINE<sup>2</sup> BURST signal) to the DUT.

**Principle of measurement:**

The analyzer weights and displays the polarity of the DUT output signal. In order for the convention

without polarity reversal = "+1 Pol" is displayed  
 with polarity reversal = "-1 Pol" is displayed

to be true, a **positive** SINE<sup>2</sup> BURST signal must be applied to the DUT. The UPL generator provides a suitable signal function (POLARITY) for this purpose.

An external signal can also be applied to the DUT provided that a suitable SINE<sup>2</sup> BURST signal is used.

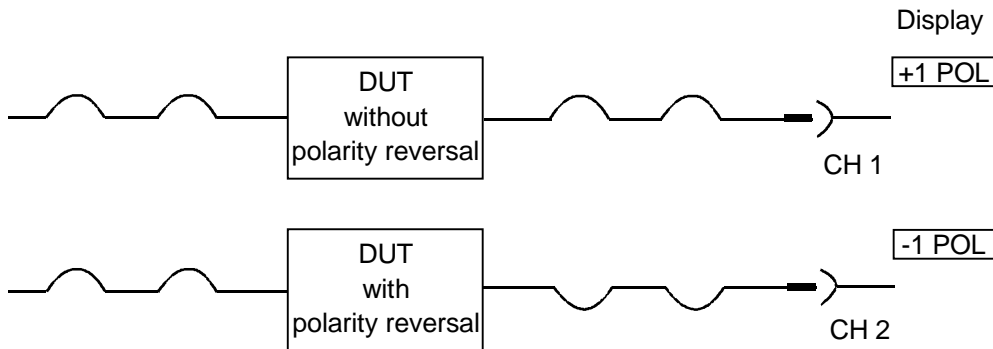

Fig. 2-27

**SPEAKER**

(see 2.6.5.1 Common Parameters of Analyzer Functions)

### 2.6.5.12 FFT (Spectrum)

Available in all analyzers.

Spectrum display of the input signal, transforming into the frequency range being effected by way of the so-called fast Fourier transform (FFT). The graphical or numerical display of the FFT can be selected in the DISPLAY panel (menu item OPERATION). The graphical display is in line with the parameters set in the DISPLAY panel. The section to be displayed (in the x and y directions) can be selected independent of the frequency range and zoomed zone selected in the ANALYZER panel. If, due to inappropriate settings in both panels, a result is outside the visible screen, this can be remedied quickly by selection of the AUTO scaling for the X and the Y-axis (see also 2.10 Graphical Data Presentation (DISPLAY and GRAPHICS Panels)).

**Note:** *In the ANLG 22 kHz and DIGITAL analyzers the input signal can be filtered with up to 3 filters. Filters cannot be used in the ANLG 110 kHz analyzer but spectrum display of a **filtered** input signal is possible by means of menu item Post-FFT of the RSM & S/N function.*

#### DC Suppres

(see 2.6.5.1 Common Parameters of Analyzer Functions)

Selectable in the digital analyzer only; corresponding setting for analog analyzers:

"Coupling AC/DC", see 2.6.2 Configuration of the Analog Analyzers

**Note:** *With DC suppression switched on, the measurement time for FFT is approx. 200 ms longer.*

#### Unit Ch1/2

Selection of the unit for the display of the RMS value for channel 1 or 2, respectively.

(cf. 2.6.5.1 Common Parameters of Functions)

The selection **entered** here is referred to for display of the spectrum in the DISPLAY panel, as standard. However, it may be overwritten in the DISPLAY panel (by entry under menu item Unit of TRACE A or B).

#### Reference

(see 2.6.5.1 Common Parameters of Analyzer Functions)

#### Chan Delay

(Interchannel delay)

Delay compensation of the DUT by entering the time by which channel 1 is to be delayed with respect to channel 2. If channel 2 has a shorter delay than channel 1, this can be compensated for by entering a negative value. Delay compensation is of relevance to phase measurements, as time discrepancies between the two test signals result in a phase shift dependent on the current frequency, which may corrupt the phase-measurement result.

Specified range: -10 s to +10 s

**Note:** *If zoom FFT is switched on, interchannel delay cannot be selected; it is set to 0 internally.*

**Filter**

(See 2.7 Analyzer Filters (FILTER Panel))  
 In analyzers ANLG 22 kHz and DIGITAL, up to three filters can be selected in Meas Mode AUDIO DATA.

**Option UPL-B29:** *No filter can be switched on in the high rate mode.*

**Notch (Gain)**

(see 2.6.5.1 Common Parameters of Analyzer Functions)

**FFT Size**

- 256
- 512
- 1024
- 2048
- 4096
- 8192

FFT size, settable from 256 to 8192 in binary steps.

The larger the FFT size (more calculated points), the better the frequency resolution, however the longer the measuring time. The number of displayable lines as a function of FFT Size and ZOOMing is given below:

Zooming ON:	maximum	FFT Size x 117/256 x 2
Zooming OFF:	analog:	FFT Size x 117/256
	digital:	FFT Size x 127/256

**Note:** *The number of displayable lines may be reduced with the "Zooming ON" setting - part of the frequency lines may fall within the negative frequency range due to eccentric "Center" setting.*

Window	
	<p><b>Selection of the window function:</b></p> <p>In system theory, the FFT treats a block of data (finite-length signal sequence) as though it were an infinite periodic sequence. In practice, however, discontinuities usually occur at the ends of the block. The discontinuities would be weighted as pulses (with white spectrum). This pulse spectrum masks the actual (useful) signal spectrum (leakage).                      Remedy: The ends of the finite-length signal sequence for the FFT are smoothly tapered to zero by windowing the data. The FFT then treats the signal as a continuous periodic sequence. Window functions thus help to minimize the leakage (at the expense of selectivity).</p>
HANN	<p><b>Range of applications of the windows:</b></p> <p>The HANN window combines selectivity with good leakage suppression for distant interferences, yet has a relatively wide bell-shaped curve around the signal lines.</p>
RECTANGULAR	<p>Window function switched off. When the signal fits exactly with an integer number of periods into the block windowed for the FFT, there will be no discontinuities at the block ends. In this case, a window is not necessary and maximum frequency resolution can be obtained. This characteristic is advantageous for fast and frequency-precise measurements of frequency responses in the case of the generator signals RANDOM / Domain: FRQ (so-called FFT noise, see 2.5.4.9 RANDOM, Domain = Frequency) and MULTISINE (see 2.5.4.4).                      (See 2.6.7.3 Fast Frequency Response Measurement)</p>
BLACKMAN-H	<p>The bell-shaped curve falls off very steeply to about 80 dB; however below this point, this window has considerable leakage.</p>
RIFE-VINC 1 RIFE-VINC 2 RIFE-VINC 3	<p>Suppression of distant interferences is excellent with all 3 windows. With increasing order of the windows, the width of the bell-shaped curve decreases at the bottom of the single lines and increases at the top. Various trade-offs between frequency resolution and suppression of close interferences can thus be made.</p>
HAMMING	<p>Offers no significant advantages, has been implemented for the sake of completeness.</p>
FLAT_TOP	<p>The top of the bell-shaped curve (which is caused only by a single sine line) is as flat as to include always two adjacent lines with approximately the same height.  <b>Advantage:</b> The amplitude can be precisely read from the graphs as against with other window functions.  <b>Disadvantage:</b> Poor frequency selectivity.</p>
KAISER	<p>The trade-off between selectivity, close interference suppression and distant interference suppression determines the selection of parameter <math>\beta</math> (from 1.5 to 20). With <math>\beta = 8</math>, selectivity is good but distant interference suppression is only about 90 dB. With <math>\beta = 16</math>, distant interference suppression is excellent, however the bell is relatively wide.                      (see 2.6.5.1 Common Parameters of Analyzer Functions)</p>

Avg Mode	<p><b>NORMAL</b></p> <p><b>EXPONENTIAL</b></p>	<p>Selection of the averaging method in the FFT</p> <p>The entered number of FFTs is executed, the partial results added and then divided by this number. With swept waterfall (OPERATION mode WATERFALL), the waterfall is displayed with respect to all sweeps points.</p> <p>Averaging is executed continuously. The current result is calculated to:</p> $AVG(n) = \frac{1}{k} \cdot FFT(n) + \frac{k-1}{k} \cdot AVG(n-1)$ <p>With swept waterfall (OPERATION mode WATERFALL), a waterfall of the intermediate results is displayed for every sweep point; then the waterfall is cleared (for the next sweep point).</p> <p><b>Notes:</b> After a restart of the measurement (e.g. caused by SWEEP, calibration or cursor movement), averaging is started anew. Average is not executed if the display mode is set to MAX HOLD.</p>
Avg Count		<p>Number of averagings (with Avg Mode NORMAL) or k (Avg Mode EXPONENTIAL, see AVG(n) formula).</p>
Zooming	<p><b>OFF</b></p> <p><b>ON (2...128)</b></p>	<p>Determines, whether the FFT is calculated from the entire frequency range or from a section only.</p> <p>"Normal" FFT, frequency range from 0 to range limit. Range limit:</p> <ul style="list-style-type: none"> <li>• analog: 117/256 * (internal) sampling rate</li> <li>• digital: 127/256 * sampling rate.</li> </ul> <p>(For the sampling rates of the individual instruments, refer to 2.6.1 Selecting the Analyzer.)</p> <p>Zoom the frequency range about the center frequency (Center) by processing the signal in the time domain before the FFT (see notes below). Zooming is effected with a factor of 2, 4, 8, ... up to 128 (16 in ANLG 110 kHz). The factor is determined by the span. The measuring time is doubled with each zoom step. The maximum zoom factor depends on the selected instrument (see below).</p>
Zoom Fact		<p>(Read only, can't be changed) Display of the zoom factor.</p>
Start		<p>(Read only, can't be changed) Display of the lower measurement limit:</p> <p>with normal FFT: 0 Hz with ZOOM-FFT: frequency of the 1st line which lies in the positive frequency range</p>



**Stop**

(Read only, can't be changed)  
 Display of the upper measurement limit in Hz or kHz  
 See table 20.

**Center**

This menu item is displayed only with Zooming ON. Center of the zoomed zone, continuously variable within the useful range of the respective instrument.

With the center frequency set closer to the **lower** range limits (0 Hz) than span /2, part of the frequency lines are allotted to the negative frequency range. These lines are **not** calculated, they are, however, not available for the frequency resolution.

If the center frequency is set closer to the **upper** range limits than span /2, part of the frequency lines exceed the frequency range. These lines contribute to the calculation and are displayed in order to enable evaluation of the behaviours at the range limits. For normal applications, this setting should be avoided, since the measured rms value may become incorrect due to aliasing components.

**Span**

This menu item is displayed only with Zooming ON. You can select out of 7 (with DIGITAL and ANLG 25) or 4 (with ANLG 110) possible zooming zones. SPAN is the entire range displayed, except for the event that Center was selected such that part of the FFT is below 0 Hz (see Center). The selection list for span is calculated depending on the current sampling rate and labeled.

**Resolution**

(Read only, can't be changed)  
 Spacings between the FFT lines in Hz or kHz. Line spacings down to the mHz range can be obtained by selecting a high zoom factor (very small span) and a long FFT (large FFT size).

Specified range:  
 normal FFT

ANLG	22 kHz	5.8598 x 8192 / FFT Size
ANLG	110 kHz	37.5 x 8192 / FFT Size
DIGITAL		sample frq / FFT Size

Zoom FFT:  
 Value of the normal FFT /zoom factor

**Meas Time**

(Measurement Time)  
 (Read only, can't be changed)  
 Time required by the analyzer for signal

### Equalizer

Activation/deactivation of an equalizer table consisting of frequency information and associated voltage gain factors.

The frequency response of a transmission link can be equalized, for example, and the measurement point can be transformed to a different reference point.

The calculated FFT bins are multiplied by a frequency-dependent equalizer factor which may be calculated by interpolating the two adjacent frequency reference points of the equalizer table. The FFT spectrum thus equalized is then displayed and used as a basis for calculating the total RMS value.

The equalization of the FFT spectrum is an interesting alternative to filtering the input signal since the equalizer file can easily be generated from the frequency response to be equalized (see 2.9.1.2) and does not have to be available as coefficient or pole/zero file.

**Typical application for acoustic measurements (e.g. mobile phones):**  
*compensation of transfer function ERP (ear reference point) to DRP (drum reference point) for measurements on artificial ears of type 3.2 or higher. The measurement of the sound waves by the microphone applied to the "eardrum" can thus be referred to the required measurement point (at the auricle).*

ON

The equalizer is switched on. The menu item 'Equal. file' is activated, i.e. the indicated file is loaded.

OFF

The equalizer is switched off; the FFT spectrum remains unchanged.

### Equal. file

(Equalizer file) only if equalizer → ON

Menu item for entering the name of the equalizer file. The file is opened and loaded into an internal buffer.

If the name entered is not valid (drive not ready, file not found, invalid format etc), an error message is displayed and "not found" is entered into the menu line.

For entering file names see 2.3.2.5;

For generating an equalizer file see 2.9.1.2 Loading and Storing of Series of Measured Values and Block/List Data ("Store → EQUALIZATN").

### SPEAKER

(see 2.6.5.1 Common Parameters of Analyzer Functions)

Table 2-31: Upper range limit for the FFT as a function of the analyzer instrument and zooming

Instrument	upper range limit for FFT	
	with normal FFT	with Zoom-FFT (depending on "Center"; maximum)
ANLG 22 kHz	21.938 kHz	21.938 kHz
ANLG 110 kHz	120 kHz	120 kHz
DIGITAL	127/256 * Sample Frq	117/256 * Sample Frq

**Note:** The antialiasing filter in the analyzer ANLG 110 kHz is effective before reaching the upper range limit, already

**Additional information on FFT:**

Width of bell-shaped curve (worst case) in lines:

Table 2-32 FFT window

Window	-20 dB	-40 dB	-60 dB	-80 dB	-100 dB
Hann	4	7	14.5	29	64
Rectangular	6.7	68	∞	∞	∞
Blackman-Harris	4.5	6	7	8	21.5
Rife-Vinc 1	4	6	9	14	21
Rife-Vinc 2	5.5	7	9	11	16
Rife-Vinc 3	6.5	8.2	10	12	14,5
Hamming	3	4	29	∞	∞
Flat_Top	7.5	9	11	14	19
Kaiser (β=8)	3.5	4.2	6	11.5	
Kaiser (β=16)	4.5	6	8	11	15

∞ this suppression will never be attained or far off only.

*Frequency measurement with FFT:*

With FFT, the spectral line with the highest signal amplitude in the with FFT: spectrum is entered as frequency value in the respective display field. With the exception of the Kaiser window, the adjacent lines are included as part of the frequency calculation, thus increasing the accuracy (on the assumption of single sine lines). In particular with the windows HANN, RIFE VINC 1 to 3, high accuracies can be obtained.

*Amplitude accuracy:*

Depending on the window and position of the single signal lines relative to the FFT lines, system-related display read errors of up to -3 dB occur. The error is worst when the selected window is narrow at its top, the input signal falling on the center between two FFT lines (e.g. in rectangular windows). Using the cursor function IMAX (interpolated maximum) for reading the peak values in the display causes the interpolation to be made on the actual peak value, the windows HANN, RIFE-VINC 1-3 providing accuracies of more than 1 % (on the assumption of single sine lines, only).

*Implementing the FFT:* The FFT has been implemented as decimation-in-frequency-FFT in complex presentation with 32-bit floating numbers. For coding, in particular the rounding noise has been optimized, reducing the errors due to FFT processing to less than -130 dB. The data are input to the analyzer at a time, the FFT being computed subsequently. Thus, the measurement is not continuous, which does however not adversely affect the measurement (with usually stationary signals).

With ZOOM-FFT, the input signal is shifted by way of convolution with a Dirac pulse at the center frequency so that the selected range falls on frequency values around zero. After lowpass filtering and subsequent undersampling, the range can be displayed with a better resolution.

A ZOOM is always implemented in three stages (up to the factor of 8). Zooming up to the factor 256 is feasible when using the "slow" instruments ANLG 22 kHz and DIGITAL. The input signal for the FFT will be complex when shifting the input signal using a single Dirac pulse. For this reason, 7488 (analog) or 4064 (digital, without zoom) points are displayable with an FFT of 8192 points! With ZOOM, the center frequency is visible in the display at about -140 dB (on technical grounds).

#### **Resolution, measurement time and span**

Example: ANLG 22 kHz and DIGITAL: (sampling rate = 48 kHz, 8192 FFT points)

Table 2-33 Resolution, measurement time and span with FFT

	max. SPAN [Hz]	max. resolution [Hz]	Measurement time [ms]
FFT	23807	5.8593	170.71
ZOOM 2:1	21938	2.9296	348.12
ZOOM 4:1	10969	1.4648	696.25
ZOOM 8:1	5485	0.7324	1392.5
ZOOM 16:1	2742	0.3662	2785
ZOOM 32:1	1371	0.1831	5570
ZOOM 64:1	686	0.0915	11140
ZOOM 128:1	343	0.0457	22280

SPAN and resolution are proportional to, measuring time is reciprocal to the sampling rate.

**Window functions:**

All window functions (except for Kaiser) are computed according to the following formula:

$$\text{Window}(i) = \sum A(n) \times \cos \frac{2\pi ni}{\text{FFT-Size}}$$

where A(n) is the respective amplitude factor of line n.

Table 2-34 Window functions with FFT, Coefficients A(n)

	<b>A(0)</b>	<b>A(1)</b>	<b>A(2)</b>	<b>A(3)</b>	<b>A(4)</b>
HANN	0.50000	-0.50000	0.0	0.0	0.0
RIFE-VINC 1	0.37500	-0.50000	0.12500	0.0	0.0
RIFE-VINC 2	0.31250	-0.46875	0.18750	-0.03125	0.0
RIFE-VINC 3	0.2734375	-0.43750	0.21875	-0.06250	0.0078125
BLACKMAN-H	0.35875	-0.48829	0.14128	-0.01168	0.0
HAMMING	0.54000	-0.46000	0.0	0.0	0.0
FLAT-TOP	0.18810	-0.36923	0.28702	-0.13077	0.02488
RECT	1.00000	0.0	0.0	0.0	0.0

The KAISER window is given by:

$$\text{Window}(i) = \frac{\text{BESSEL}(\beta * \sqrt{1 - \frac{4n^2}{N^2}})}{\text{BESSEL}(\beta)}$$

where BESSEL (i) is the modified Bessel function of 1st order.

### 2.6.5.13 FILTER SIM

Available in all analyzers.

The function FILTER SIM. is not used for measurements, but serves to check a selectable combination of filters or user-defined filters for their sum frequency response. For this purpose, filters can be selected as with the functions RMS, PEAK and QUASI-PEAK.

The filter simulation takes place with a fixed pattern in the frequency domain. This pattern results in system clock /8192; (e.g. a sampling rate of 48 kHz results in 5.86 Hz). The range from 0 Hz to half the sampling rate is simulated, producing 4096 output points in the graphics.

#### Functioning of the simulation:

The filters used in the UPL are IIR (infinite impulse response) filters. These filters are defined by poles and zeroes in the complex Z-level, conjugated complex poles and zeroes being combined to a real biquad.

These biquads feature the following transfer function:

$$H(z) = b0 \times \frac{z^2 + b_1 z + b_2}{z^2 - a_1 z - a_2}$$

4 biquads constitute an UPL filter, the coefficients b0 of the single biquads being multiplied so that a common gain is obtained. Up to 4 of such 8-pole UPL filters can be used in measurement functions.

This sum transfer function (sum of all single transfer functions) is evaluated for

$$z = \exp(jw) \quad \text{with } w = (0 \text{ to } \pi / 4096) \quad \text{and } i = 0 \text{ to } 4096$$

the denominator and numerator polynomials and the filter gain being calculated at the simulation points. Hence, the filter simulation features only a fixed resolution, extremely sharp filters (e.g. very narrow-band notch filters) cannot be simulated in this way. Actually, such filters should not be used at all, because, in the case of pole and zero positions near the unit circle, numerical accuracy problems occur or these filters have a tendency to show so-called limit cycles (i.e. signals at the filter output without a corresponding signal at the filter input).

The above frequency pattern does not apply to the use of the filters in measurements (RMS, PEAK, QUASI-PEAK), since the filters are calculated in the time domain in this case.

**Filter**

(see 2.7 Analyzer Filters (FILTER Panel))  
Up to 3 filters can be simulated.

**SPEAKER**

(see 2.6.5.1 Common Parameters of Analyzer Functions)

### 2.6.5.14 Waveform (Display in the Time Domain)

Available in all analyzers.

This function is used to display the input signal in the time domain. The trigger state being displayed in the result window, the signal in the graphics window. Level values can be read from the graphics window using the cursors. A filter selection can be made similar to the functions RMS, PEAK and QUASI PEAK.

#### Two-channel measurement:

- In the slow instruments (ANLG 22 kHz and DIGITAL), the two input channels are measured simultaneously. One of them may be selected as trigger channel; as soon as it has exceeded the trigger level, the two channels are triggered such that they are graphically displayed with correct time.
- In the 110-kHz analyzer, the two channels are measured sequentially, which is why no time reference between the two channels is specified. With continuous measurement (CONTINUOUS, see below) the switchover to the other channel is initiated even without a trigger event occurring upon reaching 10 times the memory depth at the latest. Trigger events may thus get lost. One-channel measurement is therefore required to guarantee continuous monitoring.

#### Triggering:

The UPL waits for the specified slope at the defined level.

The user may select between 2 trigger modes in order to provide for continuous monitoring on the one hand and also obtain a display even with non-triggering signals (which are too weak) on the other hand:

- CONTINUOUS (by pressing the START key) starts a continuous measurement which initiates a trigger automatically upon reaching 10 times the memory depth (trace length) at the latest. 'not triggered' is indicated in the result display. Signal monitoring is continued.
- SINGLE (by pressing the SINGLE key) starts a single measurement. The signal is only monitored until the trigger threshold is exceeded or the STOP key is actuated. The measured signal is displayed only, if a trigger event occurs. Monitoring is not interrupted in this mode. This applies also for remote or sequence control.

#### Representation:

- In the slow analyzers (ANLG 22 kHz and DIGITAL), both channels have the same time axis which applies in relation to the trigger point of the selected trigger channel.
- In the 110-kHz analyzer, the time axis of each (individual) channel applies in relation to the trigger point of the respective channel.

#### Settings:

In the analyzer panel, the mode, the trigger condition and the memory depth are set, only; in the slow analyzers, the trigger channel is set, too. Scaling of the picture (X and Y axis) is set in the display panel (see Section 2.10).

DC Suppres
------------

(see 2.6.5.1 Common Parameters of Analyzer Functions)

Selectable in the digital analyzer only;  
corresponding setting for analog analyzers:  
"Coupling AC/DC", see 2.6.2 Configuration of the Analog Analyzers

**Note:** *With DC suppression switched on, the time required for each measurement is approx. 200 ms longer.*

Meas Mode		
<p data-bbox="279 383 432 409"><b>STANDARD</b></p> <p data-bbox="279 544 472 571"><b>COMPRESSED</b></p> <p data-bbox="279 1151 469 1178"><b>UNDERSAMPLE</b></p>	<p data-bbox="539 315 1161 342">Determines the memory depth and processing mode</p> <p data-bbox="539 383 1414 504">Usual display of the samples, max. TRACE length is 7488 samples. For smoothing of the curve display (with periodic signals), the "Interpol" measurement mode can be switched on. Recommended for short recording and with periodic signals.</p> <p data-bbox="539 544 1414 819">Only for the analyzers ANLG 22 kHz and DIGITAL. In the COMPRESSED mode, the input signal is first fed to a peak-value detector (absolute value generation). Following this, the number of samples set under Comp Fact are combined. This peak value is then used as the input signal of the waveform function. Thus the x-axis is so to speak compressed, which allows long times to be acquired. Interpol can't be switched on. Recommended if <b>long</b> recording times are required and only the <b>peak value characteristic</b> is of interest.</p> <p data-bbox="539 860 1414 1010"><b>Note:</b> <i>When settings are made in the display panel, the compressed WAVEFORM can also be logarithmically displayed. This can be either directly specified (Spacing LOG) or indirectly by selecting a logarithmic unit. Power units (e.g. W, %P/P,) may also be used.</i></p> <p data-bbox="539 1050 1414 1111"><b>Application:</b> <i>Investigation of switch-on/off transients, e.g. of AGC circuits (automatic gain control)</i></p> <p data-bbox="539 1151 1414 1397">For ANLG 22 kHz and DIGITAL analyzers only. The input signal is "undersampled", i.e. the samples specified under Comp Fact are arithmetically averaged and then used as input sample for the waveform function. As a result the X axis is compressed similar to the compressed mode and long periods can be recorded. "Interpol" cannot be switched on. Recommended if <b>long</b> recording times are required and the <b>time template of the signal</b> is of interest.</p>	
	<p data-bbox="236 1487 379 1514"><b>Comp Fact</b></p>	<p data-bbox="539 1487 1235 1514">(Only for Meas Mode COMPRESSED or UNDERSAMPLE)</p> <p data-bbox="539 1532 1414 1615">Selection of the compression ratio for the compressed waveform display. Number of samples which are comprised to one sample for the waveform.</p> <p data-bbox="539 1655 858 1682">Specified range 2 to 1024</p>



## Unit

Selecting the unit for waveform display.  
(see 2.6.5.1 Common Parameters of Analyzer Functions)

The unit **entered** here is also used as standard for the waveform display in the DISPLAY panel. However, it can be overwritten in the DISPLAY panel (by an entry made under the menu item Unit of TRACE A or B).

**Note:** *Contrary to an entry in the DISPLAY panel, the unit entered here is stored when the function or instrument is changed making it available again when the function is switched back to waveform display.*

Selectable analog units (applies also to Meas Mode COMMON/INP in the DIGITAL instrument):

V | dBV | dBu | dBm | W |  $\Delta\%V$  |  $\Delta V$  |  $V/V_r$  |  $\%V/V_r$  |  $\Delta\%W$  |  $\Delta W$  |  $P/P_r$  |  $\%P$  |  $P_r$  | dB<sub>r</sub>

Selectable digital units (Meas Mode AUDIO DATA):

FS |  $\%FS$  | dBFS |  $\Delta\%$  | dB<sub>r</sub> | LSBs | bits

Selectable jitter units (Meas Mode JITTER/PHAS):

UI |  $\%UI$  | dBUI | ppm | ns | UI<sub>r</sub> | dB<sub>r</sub>

**Note:** *Logarithmic units are only possible in the Meas Mode COMPRESSED.*

## Ref Volt

(see 2.6.5.1 Common Parameters of Analyzer Functions)

In the case of waveform display the reference value can only be entered as a numeric value; this menu item corresponds to the value entered under „Reference VALUE“.

## Filter

One filter each can be selected in the ANLG 22 kHz and DIGITAL analyzers under Meas Mode AUDIO DATA.

**UPL-B29:** *No filter can be switched on in the high rate mode.*

## Trig Level

Set the trigger threshold. The threshold is entered as a fixed voltage, i.e. independent of the measurement range (which is set either fixed or using AUTO RANGE).

Specified range:

digital (audio data mode):	$\pm 1$ FS
digital (jitter mode):	$\pm 10$ UI
analog and digital common mode:	$\pm 200$ V

## Trig Slope

Specifies the edge to which should be triggered.

RISING

Rising edge

FALLING

Falling edge

**Interpol**

- 1
- 2
- 4
- 8
- 16
- 32

(Only Meas Mode STANDARD)  
 Selects the number of interpolation steps used for the display of the traced waveform.

No interpolation

Interpol > 1 causes switch-on of the interpolation algorithm  
 This setting can be used to obtain a smoothed display in the case of few samples per period of the input signal. The maximum permissible trace length is however reduced with this setting.  
 Recommended with high frequencies, which allow for recording of few samples per period, only.

**Trace Len**

The maximum settable Trace Len is a function of the sampling rate, the interpolation value and the selected measurement mode.

Specified range: 1 μs to max. Trace Len

The following is true:

$$\text{max. Trace Len} = \frac{\text{sampling rate} \times \text{Comp Fact}}{\text{sampling rate} \times \text{Interpol}}$$

The memory depth is 7488 samples.

**Trig Src**

- CHAN 1
- CHAN 2
- GEN BURST

(Trigger channel);  
 only provided in analyzers ANLG 22 kHz and DIGITAL.

Selects the source which has to trigger recording when the trigger level is exceeded. Both measurement channels - designated "coupled" in the result window - are started synchronously so that the graphical display of the two channels is made with correct time reference.

Channel 1 triggers the measurement; if channel 2 is also measured, "coupled" is displayed in the result window.

Channel 2 triggers the measurement; if channel 1 is also measured, "coupled" is displayed in the result window.

The generator signal triggers the measurement at the beginning of the "Burst On" phase, if an appropriate generator function has been selected. (If not, no waveform is generated, the graphical display is deleted and a corresponding "press show I/O" message is displayed,  
 This setting ensures that the measurement starts time-synchronously with the generator burst; internal group delays are considered automatically. Thus, the selection of GEN BURST allows for determining group delays of DUTs from the graphical representation of the waveform.

**Note:** Switching over from one-channel to two-channel measurement causes the channel which has been **measured last** to become the trigger channel.

**SPEAKER**

(see 2.6.5.1 Common Parameters of Analyzer Functions)

### 2.6.5.15 Protocol Analysis

This measurement function is only available with option UPL-B21 (Digital Audio Protocol) installed.

The protocol function is no conventional measurement function but allows for display of the channel status and user data for the AES/EBU interface. The setting is made in the DISPLAY panel (cf. 2.10.8).

### 2.6.5.16 Measurement of Digital Input Amplitude

In the UPL the measurement of the digital input amplitude is not selected as a measurement function but as an input display (INPUT DISP). To do so the measurement mode COMMON/INP has to be set (see 2.6.5.18 INPUT).

This has the advantage that the input amplitude can be indicated *simultaneously* with the display of the common measurement function.

### 2.6.5.17 Measurement of Phase between Digital Input and Reference Signal

In the UPL the phase measurement between DIG IN and REF IN is not selected as a measurement function but as an input display (INPUT/PHAS). To do so the measurement mode JITTER/PHASE has to be set (see 2.6.5.18 INPUT).

This has the advantage that the phase is displayed *simultaneously* with the measured jitter value.

### 2.6.5.18 INPUT Display

Available in all three analyzers.

INPUT DISP	Not provided in the digital analyzer in Meas Mode JITTER/PHAS.
OFF	Input display switched off
PEAK	<p>Display of the input peak value as a numeric value</p> <p>In the <b>digital analyzer</b>, the input signal is sampled with the rate specified by the user (see 2.6.3).</p> <p>In the <b>analog analyzers</b>, the input signal is, after the input level stage, sampled with the following sample rates:</p> <ul style="list-style-type: none"> <li>• ANLG 22 kHz           with    48 kHz</li> <li>• ANLG 110 kHz       with  307.2 kHz</li> </ul> <p>The input peak measurements mainly serve for checking the maximum input, indicating the peak values of the AC-coupled input signal before the filters.</p> <p><b>Exception:</b> <i>With the analog notch filter switched on in the analog measurement functions RMS, RMS SELECT, QPEAK or FFT, the input peak value is detected after the notch filter.</i></p>
RMS	<p>Display of the analog RMS value. Only provided in the analog analyzers and only effective with the measurement functions THD, TDH+N/SINAD, MODDIST, DFD and FFT; can also be displayed as sweep curve (DISPLAY – TRACE A → INP RMS CH1/2).</p>
DIG INP AMP	<p>Provided <i>only</i> with Jitter option (UPL-B22) in Meas Mode COMMON/INP. Display of digital input amplitude at selected digital input (XLR or BNC) This measurement can be performed simultaneously with any measurement function of the COMMON signal.</p>

INPUT/PHAS	Provided <i>only</i> with Jitter option (UPL-B22) in Meas Mode JITTER/PHAS.
OFF	Input display switched off.
PEAK	Display of input peak value (see INPUT DISP).
PHAS TO REF	<p>Display of the frame phase of the jittered signal between AUDIO and REF input. This measurement can be performed simultaneously with any measurement function of the JITTER signal.</p>

**INPUT DISP → PEAK or RMS**

**Unit Ch1/2**

(see 2.6.5.1 Common Parameters of Analyzer Functions)

**Reference**

(see 2.6.5.1 Common Parameters of Analyzer Functions)

**INPUT DISP → DIG INP AMP**

**Unit Ch1/2**

(see 2.6.5.1 Common Parameters of Analyzer Functions)

**Reference**

(see 2.6.5.1 Common Parameters of Analyzer Functions)

**DIG OUT AMP**

The measured value is referenced to the digital signal level set in the digital generator, i.e. to  
 - Unbal Vpp, if the UNBAL input is selected,  
 - Bal Vpp, if the BAL input is selected.

**INPUT/PHAS → PHAS TO REF**

**Unit Ch1/2**

Units: UI | %FRM | °FRM | ns

Since no relative units are used, a reference command is not offered.

### 2.6.5.19 Frequency Measurement

With the menu item **FREQ/PHASE**, which is part of the superordinate functions of the ANALYZER panel, five measurement modes can be selected:

OFF	No frequency measurement, therefore faster function measurement
FREQ	Frequency measurement on both channels
FREQ&PHASE	Frequency measurement on channel 1, phase measurement between channel 2 and 1
FREQ&GRPDEL	Frequency measurement on channel 2, measurement of group-delay or continuous phase between channel 2 and 1
SAMPLE FREQ	Display of input sampling frequency (on both channels)

Table 2-35 Frequency measurement

Instrument	Functions in combination with frequency measurement																
	RMS	RMSsel	PEAK	QPEAK	DC	THD	THD +N	MOD DIST	DFD	Wow &FL	FFT	Polarity	Filter simul	Cohe r	Rub& Buzz	1/3-Octave	WAVE - FORM
ANLG 22 kHz	√	√	n	n	n	√	√	n	n	n	√	n	n	n	√	n	n
ANLG 110 kHz	√	√	-	-	n	√	√	n-	n	-	√	n	n	-	√	-	n
DIGITAL	√	√	n	n	n	√	√	n	n	n	√	n	n	n	-	n	n

- √ valid frequency-measurement result  
 - function measurement not possible (function not available in this instrument)  
 n no frequency measurement result possible or useful (Display "-----")

The measuring time cannot be selected for the frequency measurement; if possible, the frequency information is obtained by the selected function measurement using various methods:

1. With the two RMS measurements (without POST FFT), it is derived from the number of zero crossings.
2. With other measurements (even OFF function) it is derived from the FFT.

The 1st procedure offers the advantage of high measuring speed, while the 2nd method supplies accurate measured values even with very poor signal-to-noise ratio and/or high frequencies. Thus, the user may optimize frequency measurement for his test signal by selecting the appropriate function - unless a specified function has to be measured, simultaneously:

1. RMS function (without POST FFT) for signals with high signal-to-noise ratio with low to medium frequencies.
2. FFT function or RMS with POST FFT or Function OFF for signals with low signal-to-noise ratio and without low frequencies.

**The RMS function** allows for increasing the accuracy of frequency measurement by switching on the POST FFT. With POST FFT switched on the frequency measurement result is derived from the FFT if the frequency drops below a lower cut-off frequency - irrespective of an optional spectrum display (menu item "OPERATION" in the DISPLAY panel). This lower cut-off frequency of the FFT is 4 times the FFT resolution and can thus be modified by the user via the FFT size (see 2.6.5.2 RMS).

The measuring accuracy of **the FFT-based frequency measurement** depends on the following parameters

- *Window function:* The RIFE VINCent windows 1 or 2 are suited best.
- *FFT-Size:* as high as possible, best 8192

- **Zoom-FFT:** although switching on Zoom-FFT increases the measuring time (just like a big FFT size), the resolution and accuracy are improved (particularly with low frequencies).
- **Zoom factor:** set by selection of "Span". The smaller the span, the larger the zoom factor and the better the frequency resolution and accuracy.  
*Note:* "Span" and "Center" must be selected such that the desired measurement range from Start to Stop is covered.  
*Recommendation:* Excellent measurement accuracy can already be obtained with a zoom factor of 2 without the need for limiting the frequency range of the instrument. To this end, "Center" must be set to "Span / 2".

**Example:** Configure the FFT as indicated below in the measuring range ANLG 22 kHz:

FFT Size	8192
Window	RIFE VINC 2
Avg Count	1
Zooming	ON ( 2 to 128)
Center	11.975 kHz
Span	21.94 kHz

Thus, measurement range and resolution are obtained:

Zoom Factor	2
Start	6.25 Hz
Stop	21.938 kHz
Resolution	2.9297 Hz

**Note:** With Function OFF, the frequency measurement is performed according to the FFT settings described in the example.

<b>Meas Time</b>
------------------

<b>FAST</b>
<b>PRECISION</b>

Definition of measurement time and precision of the frequency measurement for the measurement functions OFF and RMS. Does not influence the other measurement functions.

The frequency measurement (for the measurement function OFF also the phase measurement) is set to attain optimum speed:

**RMS:** The measurement may be performed without post FFT; the frequency is determined on the basis of the number of zero crossings, unless the user actually switches on post FFT.

**OFF:** The measurement is performed at reduced FFT size (4 k FFT) and without zooming, which makes it around four times faster than the PRECISION measurement.

The frequency measurement (for the measurement function OFF also the phase measurement) is set to attain optimum precision:

**RMS:** Post FFT (8 k FFT, without zoom) is switched on automatically to obtain a more precise measurement result.

**OFF:** The measurement is performed at maximum FFT size and with zoom (factor 2) switched on. For low frequencies an additional measurement is performed using an increased zoom factor.

**Unit Ch1/2**

Selection of the result units for channel 1/2.

With frequency measurement, the (display) units for both channels can be selected individually, in order to display one channel as absolute quantity and the other one with any reference, by way of example.

Selectable units:

Hz |  $\Delta$ Hz |  $\Delta\%$ Hz | Toct | Oct | Dec | f/f<sub>r</sub>

Refer to Section 2.4 Units, for conversion formulae and the notation of the measurement result display for IEC/IEEE-bus control.

**Ref Freq**

(see 2.6.5.1 Common Parameters of Analyzer Functions)

**Freq Sett1**

(see 2.6.5.1 Common Parameters of Analyzer Functions)



### 2.6.5.20 Combined Frequency, Phase and Group Delay Measurement

Only for the analyzers ANLG 22 kHz and DIGITAL in two-channel mode  
(Channel(s) 1&2 | 1≡2 | 2≡1 | BOTH )

Table 2-36 Availability of phase/group-delay measurement

Instrument	Functions in combination with phase measurement																
	RMS	RMSsel	PEAK	QPEAK	DC	THD	THD +N	MOD DIST	DFD	Wow &FL	FFT	Polarity	Filter simul	Cohe r	Rub& Buzz	1/3-Octave	WAVE - FORM
ANLG 22 kHz	√	n	n	n	n	n	√	n	n	n	√	n	n	n	n	n	n
ANLG 110 kHz	n	n	-	-	n	n	n	n	n	-	n	n	n	-	n	-	n
DIGITAL	√	n	n	n	n	n	√	n	n	n	√	n	n	n	-	n	n

- √ valid result of phase and group-delay measurement
- function measurement not possible (function not available in this instrument)
- n no result of phase or group-delay measurement possible or useful (display "-----")
- (BRM) base rate mode: standard in option UPL-B2, selectable in option UPL-B29 (digital audio 96 kHz)
- (HRM) high rate mode selectable in option UPL-B29 (digital audio 96 kHz) only
- (1) only possible if no filters are selected and 'Meas Time' is set to VALUE or GEN TRACK
- (2) only with zooming switched off

The phase difference is obtained in the phase measurement from the signals of channels 1 and 2. The phase-measurement results are in the 0 to 360° and -180 to +180° ranges. With frequency sweep running, however, the phase may be continuously measured, ie outside the 360° and -180° limits (continuous phase measurement), provided certain conditions are fulfilled (see group-delay measurement).

For continuous phase measurement select GROUP DELAY and a phase unit.

**The signal of channel 1 is used as reference signal.**

**Note:** The result of the phase measurement is derived from the FFT or POST FFT. If phase or group-delay measurements are performed in conjunction with RMS function, switch-on of the POST FFT is forced, therefore; the frequency-measurement result is derived from the POST FFT, also, provided that the frequency is above the lower cut-off frequency of the FFT (4-fold resolution due to bell-shaped DC offset). The POST FFT may be displayed as spectrum but this is not a must (menu item OPERATION in the DISPLAY panel).

For **group delay measurements**, the phase is differentiated with respect to the frequency, ie the differential quotient is evaluated:

$$\tau_2 = \Delta\phi / (2\pi \times \Delta f) \quad \Delta\phi = \phi_{2meas} - \phi_{1meas}$$

For **continuous phase measurements**, the difference of two consecutive phase-measurement results is added to the first phase-measurement result:

$$\phi_2 = \Delta\phi + \phi_1 \quad \Delta\phi = \phi_{2meas} - \phi_{1meas}$$

Both measurements are available in the GROUP DELAY menu item. They are only defined for *changes* in the frequency and therefore only make sense in conjunction with frequency sweeping. If they are attempted at a constant frequency, an error message will be issued.

If a frequency sweep is to be set for measuring group delay or continuous phase, the following should be noted:

- Select the frequency step size and/or the number of sweep points such that phase shifts exceeding 180° between 2 subsequent sweep points cannot occur.
- Spacing should be linear, since, with logarithmic spacing, the frequency increments could be too small with low frequencies and the phase shift could be too large with high frequencies.

When measuring the group-delay versus frequency (e.g., by means of a generator frequency sweep), the first sweep point is not defined, respectively, since a reference point for calculation of the delta values of frequency and phase is not available before obtaining the 2nd frequency value.

**Unit Ch1/2**

Selection of units for the measurement for channel 1 and 2.

Selectable units for the frequency measurement (channel 1):

Hz | ΔHz | Δ%Hz | Toct | Oct | Dec | f/f<sub>r</sub>

Selectable units for the phase measurement (channel 2):

° | RAD | Δ° | ΔRAD

Selectable units for group-delay measurement (channel 2):

s | Δs

**Note:** *Continuous phase is obtained by selecting ° or RAD under GROUP DELAY.*

Refer to section 2.4, Units, for conversion formulae and notation of the measurement result display units for IEC/IEEE-bus control

**Ref Freq**

(See 2.6.5.1 Common Parameters of Analyzer Functions)

**Format Pha**

(Format phase) Displayed range of phase values:

**0 ... 360°**

from 0 to 360°; selectable, if UNIT CH2 ° | Δ°

**-180 ... + 180°**

from -180° to +180°; selectable, if UNIT CH2 ° | Δ°

**-360 ... 0°**

from -360 to 0°; selectable, if UNIT CH2 °|Δ°

**0 ... 2 Π**

from 0 to 2π; selectable, if UNIT CH2 RAD | ΔRAD

**-Π ... +Π**

-π to +π; selectable, if UNIT CH2 RAD | ΔRAD

**-2 Π ... 0**

from -2π to 0; selectable, if UNIT CH2 RAD | ΔRAD

**Note:** *Continuous phase representation (-∞ to +∞) is possible under GROUP DELAY if a phase unit is selected instead of the usual time unit.*

**Ref Phase**

(See 2.6.5.1 Common Parameters of Analyzer Functions)

**Freq Settl**

(See 2.6.5.1 Common Parameters of Analyzer Functions)

**Phas Settl**

(See 2.6.5.1 Common Parameters of Analyzer Functions)

### 2.6.5.21 Measurement and display of analyzer sampling frequency

Only available in the digital analyzer.

When selecting SAMPLE FREQ, the measured sampling frequency is displayed on the channels switched on (or in the frequency window of the JITTER/PHAS or COMMON MODE measurement). Irrespective of the selection of menu item FREQ/PHASE, the sampling frequency is always measured internally and can also be displayed in the PROTOCOL panel (provided that option UPL-B21 is fitted).

**Unit Ch1/2**

Selection of the result units for channel 1 and 2.

Selectable units for the sampling rate:

Hz | ΔHz | Δ%Hz | Toct | Oct | Dec | f/f<sub>r</sub>

Refer to Section 2.4 Units for conversion formulae and notation of the measurement result display units for the IEC/IEEE-bus control.

**Ref Freq**

(see 2.6.5.1 Common Parameters of Analyzer Functions)

**Freq Settl**

(see 2.6.5.1 Common Parameters of Analyzer Functions)

**2.6.5.22 Coherence Measurement and Transfer Function**

This function can only be selected with built-in option UPL-B6 (Extended Analysis Functions). It is limited to the DIGITAL and ANLG 22 kHz instruments.

The analyzer calculates the transfer function CH1/CH2 (Trace A) and the coherence function (similarity, Trace B) of two signals. In the DISPLAY panel graphical or numerical display of the coherence can be switched on (under menu item OPERATION). The graphics display is in accordance with the parameters set in the DISPLAY panel. The section to be displayed (X and Y direction) can be selected independent of the frequency range selected in the ANALYZER panel.

**Measurement method:**

The complex FFT is calculated for each channel, the two channels being measured at exactly the same time. The cross-correlation between the two FFTs is formed and averaged. The square of the cross-correlation is divided by the averaged size of the individual FFTs; the coherence result is thus independent of the selected measurement ranges.

$$\gamma^2 = \frac{|\sum \text{Kanal1} \otimes \text{Kanal2}|}{\sum |\text{FFT}(\text{Kanal1})| \cdot \sum |\text{FFT}(\text{Kanal2})|} \quad \text{where } 0 \leq \gamma^2 \leq 1$$

$\gamma^2 = 1$  means that at this frequency channel 2 is linearly dependent on channel 1. The accuracy of the measurement increases with the number of averaging performed.

The transfer function is calculated as follows:

$$H(z) = \frac{\sum |\text{FFT}(\text{Kanal1})|}{\sum |\text{FFT}(\text{Kanal2})|} \quad \text{relevant standard: ANSI S3.42-1992}$$

**Application:**

The coherence measurement function uses test signals which cover the entire audio spectrum; it is therefore recommended to set the generator to noise (both in terms of time and frequency). The generator signal should be applied simultaneously to the input of the DUT and the analyzer channel 2 (reference channel). The output of the DUT is connected to analyzer channel 1 (measurement channel).

**Note:** *The coherence measurement performs complex calculations and requires synchronous two-channel input signals. This brings about some limitations:*

- *The coherence function is only available for the instruments DIGITAL and ANLG 22kHz.*
- *Since the coherence measurement is a comparative measurement between channel 1 and channel 2, both channels must be active.*

In contrast to other measurements, no test result is computed in this case but two permanently assigned curves are drawn which can only be stored and loaded together (as "DUAL FILE" in the DISPLAY panel.

- Trace A (menu item FUNC CH1): transfer function CH1/CH2
- Trace B (menu item FUNC CH2): coherence result  $\gamma^2$

The number of averagings performed  $n$  is displayed in relation to the number of averagings desired  $m$ .

*averaging  
n of m*

<b>Unit</b>	<p>Selects the display unit for the transfer function; % or dB can be selected.</p> <p>The selected unit is also used as standard for the spectrum in the DISPLAY panel, but it can be overwritten by an entry in the menu item "Unit" of TRACE A in the DISPLAY panel.</p>
<b>Chan Delay</b>	<p>(Interchannel delay)</p> <p>Delay compensation of the DUT by entering the time by which channel 1 is to be delayed with respect to channel 2. If channel 2 has a shorter delay than channel 1, this can be compensated for by entering a negative value.</p> <p>Specified range: -10 s to +10 s</p>
<b>FFT Size</b>	<p>Size of FFT, settable in steps of 2 between 256 and 8192.</p>
<p>256 512 1024 2048 4096 8192</p>	<p>A larger FFT size (i.e. more calculated points) implies a finer frequency resolution but also correspondingly longer measurement times.</p>
<b>Window</b>	<p>Selects the window function</p>
<p>HANN RECTANGULAR BLACKMAN-H RIFE-VINC 1 RIFE-VINC 2 RIFE-VINC 3 HAMMING FLAT TOP KAISER</p>	<p>Same as with FFT</p>
<b>Avg Count</b>	<p>Number of averaging operations; the coherence function requires a great number of averaging procedures to obtain accurate results. Averaging numbers above 30 are recommended.</p>
<b>Start</b>	<p>(Display only, no changes possible)</p> <p>Display of lower measurement limit in Hz or kHz; since no zoom FFT is to be performed here, the lower limit is always 0 Hz.</p>
<b>Stop</b>	<p>(Display only; no changes possible)</p> <p>Display of upper measurement limit in Hz or kHz.</p>
<b>Resolution</b>	<p>(Display only; no changes possible)</p> <p>Display of spacing between FFT lines in Hz or kHz.</p> <p>Specified range: <math>5.8598 \times 8192 / \text{FFT Size}</math></p>

**Note:** A normalization factor can be entered for Trace A (transfer function) in the DISPLAY panel (or transferred from the cursor position). Thus the transfer function can be set to 0 dB at any position.

**2.6.5.23 Loudspeaker Measurements (RUB & BUZZ)**

This item can only be selected with built-in option UPL-B6 (extended analysis functions) and is offered in the analog analyzers only.

**UPL-B29:** *In the high rate mode, the RUB&BUZZ measurement is not available.*

Loudspeaker measurements can only be performed with the internal universal sinewave generator. When the RUB & BUZZ item is selected, suitable **generator** setting is automatically performed, if applicable.

INSTRUMENT	ANALOG
FUNCTION	SINE
Low Dist	OFF

Loudspeaker measurements are made up of different measurements some of which can be performed simultaneously. Measurements performed:

- **RUB & BUZZ measurement** with fixed or tracking highpass filter or a combination of the two,
- *simultaneous frequency response measurement*,
- **polarity measurement** of the loudspeaker at the end of a sweep or single measurement.

**Connecting the test equipment:**

The UPL generator is connected to the loudspeaker or - in the case of high signal levels - to a power amplifier.

The precision microphone is connected to one or both test inputs of the UPL analyzer - possibly via an amplifier - depending on the measurement range (see below).

The RUB & BUZZ measurement is always performed in channel 1, the measurement result is available as the result of channel 1 (SENS1:DATA1)

The (unfiltered) frequency response measurement result is available

- in the 22 kHz analyzer as measurement result in channel 2 (SENS1:DATA2)
- in the 110 kHz analyzer as input RMS value in channel 1 (SENS2:DATA1).

The polarity measurement result is displayed as a phase value (SENS4:DATA).

The mentioned measurements can be performed in both analog analyzers, but there are certain differences with a view to operation and connections:

	<b>ANLG 22 kHz</b>	<b>ANLG 110 kHz</b>
<b>Connection of precision microphone:</b>	To both measurement channels in parallel	to measurement channel 1
<b>Channel selection</b>	One or two channels; any selection is possible	single-channel only CH1 only
<b>Activation of RUB&amp;BUZZ measurement:</b>	Activation of channel 1: Channel(s) 1, 1&2, 1≐2 or 2≐1	Permanently active
<b>Activation of frequency response measurement:</b>	Activation of channel 2: Channel(s) 2, 1&2, 1≐2 or 2≐1	Activation of Input Disp RMS
<b>Activation of polarity measurement:</b>	FREQ/PHASE → FREQ&PHASE FREQ/PHASE → FREQ&GRPDEL	FREQ/PHASE → FREQ
<b>Deactivation of polarity measurement:</b>	FREQ/PHASE → OFF FREQ/PHASE → FREQ	FREQ/PHASE → OFF

**RUB & BUZZ measurement**

This measurement is used to detect manufacturing faults in loudspeakers, which are audible as non-harmonic noise or high harmonics. Since even a properly functioning loudspeaker produces k2 and K3 harmonics, THD+N measurements are not suitable in this case. A measurement function is required instead, which not only suppresses the fundamental but also the next higher harmonics and measures only the residual signal.

The method used here measures the RMS value after a highpass which filters out all "legal" harmonics. Depending on the application, the passband frequency

- is set to a fixed frequency,
- tracks the n-fold generator frequency,
- fulfills a combination of both.

**Frequency response measurement:**

The frequency response measurement corresponds to an RMS measurement without filter. In the ANLG 110 kHz instrument the accuracy of the RMS measurement is however not fully attained because the measurement time of the input RMS result is not matched to the signal period.

**Polarity measurement:**

This polarity measurement is tailored to measurements of the loudspeaker *chassis*. It is *not* suitable for measuring loudspeaker *systems* and should not be confused with the POLARITY function for measuring electrical systems such as frequency filters.

The polarity measurement is switched on via the FREQ/PHASE menu item, which is at a higher level than the measurement function (see table further up).

Same as with the POLARITY measurement function, the measured value is indicated with "+ Pol" for correct polarity and "- Pol" for incorrect polarity. In the case of remote or automatic sequence control, a positive numeral is read out for correct polarity and a negative one for incorrect polarity. This numeral also yields a measure for the reliability of the measurement result. The higher the magnitude of the measured value, the more reliable the correct/incorrect polarity criterion. With values between -1.5 and +1.5 the test setup and device settings (e.g. delay) should be checked.

**Optimizing the measurement speed:**

This measurement function was implemented especially for production tests, i.e. for the purpose of high measurement speed. To ensure the full use of all capabilities the following should be observed:

ANALYZER panel:

Range	FIX	
FREQ/PHASE	OFF	(if a polarity measurement is <i>not</i> required)
Meas Time	GENTRACK	
Sweep Mode	FAST or BLOCK	(if a generator sweep is performed)

OPTIONS panel:

Beeper	OFF
Meas Disp	OFF

Switch off graphics cursor

Switch off graphics display (3-panel display) (if only results are required)

The settling time of the filters can also be shortened, but this reduces the measurement accuracy. This is done via the call parameter when the UPL is started:

-tfilxx.yy

xx and yy are factors for modifying the settling time  
11 to 99: Settling time shortened to 0.9 to 0.1



1 to 9            Settling time extended by 10 to 1.1  
 xx: reduces the settling time of an optional lowpass filter  
 yy: reduces the settling time of the standard highpass filter

**Example:** if UPL is started with

UPL -tfil99.30,

(standard value), the settling time of the optional lowpass filter is reduced to 10% and that of the standard highpass filters to 25% of the theoretical value.

<b>Meas Time</b>	(Measurement time)
<b>AUTO FAST AUTO</b>	The measurement time of the RUB & BUZZ measurement is used to adapt the measurement speed to the signal frequency. In most cases - particularly in the case of sweeps - the selection of GEN TRACK is recommended since RUB & BUZZ assumes the use of the internal function generator.
<b>VALUE</b>	Automatic matching of the measurement time to the signal frequency taking into account the signal period. This is only useful when an unknown signal frequency is used or the generator frequency modification cannot be accepted, which is unavoidable in the case of GEN TRACK. (see 2.6.5.2 RMS)
<b>GEN TRACK</b>	Numerical entry of desired measurement time. This is only useful when an unknown signal frequency is used or a very weak signal is to be measured. (see 2.6.5.2 RMS)
<b>GEN TRACK</b>	Measurement taking up (at least) one whole generator signal period. If required, the generator frequency can be adapted to the analyzer sample rate. To increase the measurement accuracy in the case of high frequencies, the measurement time is extended to several periods. This mode guarantees maximum accuracy at a minimum measurement time and should be given preference. (see 2.6.5.2 RMS)
<b>Unit Ch1/2</b>	Selects the units for the RUB & BUZZ measurement results in channel 1 and channel 2.
<b>Reference</b>	Reference values for the RUB & BUZZ measurement.

**FREQ MODE**

Determines the highpass filter type

**FIX**

A fixed highpass filter is used; the numeric value of the passband frequency is entered in the menu line below.

**GEN TRACK**

(Generator tracking)

A tracking highpass filter is used which should preferably be tuned to about the 5th harmonic of the generator frequency. The multiple by which the passband frequency should be higher than the generator frequency can be entered under "Factor" in the next menu line.

The frequency limits, within which tracking of the filter frequency should be performed, can be selected in addition. When a limit is reached (FrqLim Low or Upp) the filter frequency is held at this frequency. Thus a tracking highpass filter can be produced which becomes a fixed-frequency highpass filter below FrqLim Low and/or above FrqLim Upp.

If tracking should be performed over the entire frequency range, the frequency limits should be set to the minimum and maximum value.

**Factor**

Specifies the factor by which the passband frequency should be higher than the generator frequency. For the Rub & Buzz measurement a factor of approx. 5 would be appropriate.

Specified range: 2 to 20

When the product of generator frequency and factor reaches

- the FrqLim Upp value, the highpass filter is held at this frequency
- the upper frequency limit of the analyzer, Rub & Buzz is not carried out and an error message ("Input? Press Show IO") is displayed instead. The remaining measurement (transfer function in the other channel or below Input Disp) is performed at a higher speed.



**Filter**

(See 2.7 Analyzer Filters (FILTER Panel))

Two (digital) filters can be selected in addition to the standard highpass filter.

**Use:** *Lowpass filter for band limiting (particularly in the ANLG 110 kHz instrument), delay filter for extending the settling time, bandstop filter for eliminating interfering lines, etc.*

**Note:** *Same as the standard highpass filter, the filters selected here are only active for measurement channel 1. Channel 2 (in 22 kHz analyzer) and the input RMS of channel 1 (in 110 kHz analyzer) are measured without filter.*

**FrqLim Low**

With FREQ MODE → GEN TRACK only; lower band limit for tracking the frequency of the highpass filter.

If the product of generator frequency and factor drops below the value specified here, the passband frequency of the highpass filter is held at this value.

Specified range:

ANLG 22 kHz: 10.0 Hz to 21.938 kHz

ANLG 110 kHz: 20.0 Hz to 120 kHz

**FrqLim Upp**

With FREQ MODE → GEN TRACK only; upper band limit for tracking the highpass filter frequency.

If the product of generator and factor exceeds the value specified here, the passband frequency of the highpass filter is held at this value.

Specified range:

ANLG 22 kHz: FrqLim Low to 21.938 kHz

ANLG 110 kHz: FrqLim Low to 120 kHz

**SPEAKER**

(see 2.6.6 Headphone/Speaker Output)

In the 22 kHz analyzer, the (residual) Rub & Buzz signal in channel 1 and the unfiltered signal in channel 2 can be monitored. This is done by selecting FUNCT CH1 or CH2 provided the selected channel is also active as a measurement channel.

If the Rub & Buzz signal exceeds the bandwidth of the employed analyzer, the monitoring output FUNCT CH1 is muted to avoid noise during sweeps, which would degrade the measurement of Rub & Buzz.

### 2.6.5.24 Third Analysis (1/3 OCTAVE)

This selection is only available in combination with Option UPL-B6 (Extended Analysis Functions). It is generally not available with the 110 kHz analyzer.

**UPL-B29:** *In the high rate mode (see 2.15.9 Selecting the Sampling Mode), 1/3-octave analysis is available in the analog analyzer only.*

With the third analysis, the levels in up to 32 third-octave bands are measured simultaneously. The analysis is performed according to standard IEC 1260 of 1995 with level accuracy of class 0 ( $\pm 1,0$  dB).

The bandwidth of a third-octave band relative to the band center is  $\sqrt[6]{2} - \frac{1}{\sqrt[6]{2}}$  (= 1/3 octave). The third-octave filters are designed as 4th-order Chebychev filters. The reference frequency of 1 kHz is used as a basis for calculating all the other center frequencies of the band.

The third-octave bands to be measured are selected by entering lower and upper frequency limits. A separate RMS value is determined for each third-octave band and displayed either graphically or numerically. The total RMS value for all the selected third-octave bands is displayed. If necessary, it can also be displayed as a bar graph or (for specialist applications with frequency sweep) a curve plot.

The precisely calculated third-octave bands are used as a basis for the *measurement*. The nominal band center frequencies are rounded to two or three significant digits and used for the *numeric representation* of the thirds (operation SPECTR LIST). With the *graphic representation* (operation SPECTRUM), only the octaves are labelled as space is limited.

The measurement range of the third analysis begins at the nominal band center frequency of 16 Hz (15.87 Hz) and ends at 20 kHz. The total bandwidth ranges from 14.1 to 22449.2 Hz, that is the total audible range.

Third analysis in UPL is performed for one channel only. Dual-channel measurements should normally be avoided, as the multiplexing that is required makes continuous measurement of both channels impossible and the channels therefore have to settle to steady state each time a single measurement has been performed. However this measurement mode may be suitable for single measurements with long measurement times. Of course both traces may also be used also for single-channel measurements, eg trace B for displaying a comparison spectrum. If two traces are used, the thirds are superimposed, which gives a very clear picture on a colour display: the overlaying portions of the two traces are displayed, as in other measurements, a mix of the colours used.

Pink noise, which can also be generated by the UPL, is recommended as *trigger signal* for the third analysis. Unlike white noise, its level roll-off of  $\sqrt{1/f}$  compensates for the apparent level increase encountered with third analysis, which results from the absolute bandwidth increasing as the frequency increases.

## Line Count

30

32

Determines the number of thirds which can be measured and displayed. The number was 30 up to software 2.02. A (continuous) reduction of thirds is also possible without this menu item by simply entering "FrqLimLow" and "FrqLimUpp". This menu item is principally provided to maintain compatibility.

Maximum 30 thirds can be calculated and displayed. The lowest third which can be measured has a nominal center frequency of 25 Hz

"30" is mainly required to maintain compatibility with earlier written remote and sequence control programs.

In addition, 2 low-frequency thirds, i.e., maximum 32 thirds, can be calculated and displayed. The lowest third which can be measured has a nominal center frequency of 16 Hz.

"32" should be set with writing any new remote and sequence control programs and setups.

## Meas Time

VALUE

(Measurement Time)

The only parameter determining the measurement speed is the measurement time, which is entered as a numeric value. To minimize measurement uncertainties, the selected measurement time is rounded to integer multiples of 512 samples, which corresponds to a step width of approx. 10.6 ms for the analog analyzer (internal sampling rate 48 kHz). For long-time measurements, measurement times of up to 12 hours can be selected.

The measurement time also determines the update rate of the third analysis. Shorter measurement times lead to results being displayed faster but for shorter times. Each time the selected measurement time elapses, the *third* results are updated. No intermediate results are displayed. The update rate of the measurement result can be reduced by entering the "reading rate" in the OPTIONS panel. If the selected measurement time is too short, the lower third measurement results become inaccurate ("noisy"). If the measurement results are of considerably more interest than the graphic representation, the selected measurement time should be long enough to yield sufficiently accurate measurement results for even the lowest third that is required.

Specified range:

ANLG 22 kHz: 10.67 ms to 720 min (12 h)

DIGITAL:  $512 / f_{\text{sample}}$  to 720 min

Units: s | ms |  $\mu$ s | min

**Note:** *The measurement time of the first measurement is increased by the settling time of the slowest third octave filter. To reduce this delay the "frequency limit low" can be raised. Thus the calculation, delay and display of the lower third octaves are omitted.*

**Max Hold**

- OFF
- FOREVER
- SLOW DECAY
- FAST DECAY

Hold function for the maximum result of each third. The function can be turned off. Reset by pressing the START key. Just like the measurement results of the thirds, the max-hold values can be displayed either graphically as horizontal markers in the spectrum or numerically in a spectrum list. They are available via auto and remote control. To present numerical results, switch on Scan #2 (PgUp or PgDn key). Graphically the maximum values are indicated by narrow horizontal lines at the top of the associated third bars.

Max-hold function switched off; only the third bars are displayed.

Max-hold function switched on; the markers lie on the maximum values; reset only by starting the measurement (START key).

Max-hold function switched on; the markers lie on the maximum values for the "hold time" to be set in the following line and then decay exponentially (time constant 0.5 s).

Max-hold function switched on; the markers remain on the maximum values for the "hold time" to be set in the following line and then go back to the current measurement value for the third.

**Note:** *The counter for the hold time is reset and restarted whenever a new maximum value occurs. Each third has its own counter, so each marker can move independently.*

**Hold Time**

Only for Max Hold --> SLOW / FAST DECAY

Setting of the time for which the maximum value of a third is held before the marker returns to the measured value. The selected hold time does not influence the decay time.

**Unit Ch1/2**

(See 2.6.5.1 Common Parameters of Analyzer Functions)

**Reference**

(See 2.6.5.1 Common Parameters of Analyzer Functions)

GEN TRACK is not available for third analysis, as this analysis is usually triggered by noise signals (eg pink noise), for which generator tracking is not defined.

**Filter**

(See 2.7 Analyzer Filters (FILTER Panel))

One standard or user-defineable filter can be selected.

**UPL-B29:** *No filter can be switched on in the high rate mode.*

**FrqLim Low**

Lower band limit for third analysis. The representation and calculation of the third bands start with the band containing the lower limit frequency. Any signals below the lowest third band will not be included in the calculation of the total RMS value. The higher the lower limit frequency, the faster the signal will settle and the shorter the time for first measurement.

Specified range: depends on "Line Count" (values in brackets apply for 30 lines)

ANLG 22 kHz: 14.254 Hz (22.627 Hz) to 21.938 kHz

DIGITAL: 14.254 Hz (22.627 Hz) to  $f_{\max}$

$f_{\max}$  depends on the sampling rate and does not exceed 22 449 Hz

**Note:** *In single measurement mode (e.g. frequency sweep), all third octave filters must have settled prior to starting the measurement. Thus the measurement time for **each** single measurement is increased by the the filter delay. In order to reduce filter delay only as many low-frequency thirds should be measured as required by the measuring task. FrqLim Low should be set **as high as possible***

**FrqLim Upp**

Upper band limit for third analysis. The representation and calculation of the third bands ends with the band containing the upper limit frequency. Any signals above the top third band will not be included in the calculation of the total RMS value. Frequency limit upper does not affect the measurement time.

Specified range:

ANLG 22 kHz: FrqLim Low to 21.938 kHz

ANLG 110 kHz: FrqLim Low to  $f_{\max}$   $f_{\max}$  depends on the sampling rate and does not exceed 22 449 Hz

**SPEAKER**

(See 2.6.6 Headphone/Speaker Output)

The input signals of channel 1 or channel 2 (without filter) can be monitored.



### 2.6.5.25 12<sup>th</sup> OCTAVE Analysis (12<sup>th</sup> OCTAVE)

This selection is only available in combination with Option UPL-B6 (Extended Analysis Functions). It is generally not available with the 110 kHz analyzer.

**UPL-B29:** *In the high rate mode (see 2.15.9 Selecting the Sampling Mode, 12<sup>th</sup> octave analysis is available in the analog analyzer (ANLG 22 kHz), only.*

With the 12<sup>th</sup> octave analysis, the levels in up to 125 frequency bands can be measured simultaneously. In contrast to the third analysis, the levels of the individual frequency bands are not measured using narrow-band bandpass filters but by means of a special zoom FFT integrating the FFT bins in the individual bands (frequency lines).

The **advantages compared to the third analysis** are a higher resolution and the dual-channel measurement which allows for considering a reference signal in addition to the measurement signal at the same time.

The **disadvantage compared to the third analysis** is the rough stepped measurement time which is an integer multiple of the FFT measurement time. Moreover, monitoring without gaps cannot be guaranteed. However the monitoring gaps are not critical with most applications, in particular, if a reference signal is determined simultaneously on the 2nd channel.

The bandwidth of a 12<sup>th</sup> octave band relative to the band center is  $\sqrt[24]{2} - \frac{1}{\sqrt[24]{2}}$  (= 5.77%).

The reference frequency of 1 kHz is used as basis for calculating all the other center frequencies of the band by multiplication or division  $\sqrt[12]{2}$ . The nominal band center frequencies are derived from standard DIN 323.

The frequency bands to be measured are selected by entering lower and upper frequency limits. A separate RMS value is determined for each selected frequency band by integrating all FFT bins of this band and is then displayed either graphically or numerically. The total RMS value for all the selected frequency bands is displayed. If necessary, it can also be displayed as a BAR GRAPH or (for specialist applications with frequency sweep) a CURVE PLOT.

The measurement range of the third analysis begins at the nominal band center frequency of 16 Hz (15.87 Hz) and ends at 20 kHz. The total bandwidth ranges from 15.4 to 20586 Hz, that is the total audible range.

The precisely calculated frequency bands are used as a basis for the *measurement*. The nominal band center frequencies are used for the *numeric representation* of the 12<sup>th</sup> octaves (operation SPECTR LIST). With the *graphic representation* (operation SPECTRUM), only the octaves are labelled as space is limited.

As an alternative to the spectrum representation of the discrete frequency bands (operation SPEKTRUM) the 12<sup>th</sup> octave analysis may also be represented as curve plot (operation CURVE PLOT), if no sweep is activated. This representation provides the advantage of scaling the graphics into both directions as desired such that even small sections of the frequency range can be clearly arranged. With remote or sequence control the first measured frequency line may preferably assume the index 0 in the trace data set, whereas index 0 always refers to the frequency line 16 Hz with the spectrum representation independent of being measured or not.

Pink noise, which can also be generated by the UPL, is recommended as *trigger signal* for the third analysis. Unlike white noise, its level roll-off of  $\sqrt{1/f}$  compensates for the apparent level increase encountered with 12<sup>th</sup> octave analysis, which results from the absolute bandwidth increasing as the frequency increases.

**Meas Time**

**VALUE**

(Measure Time)

The only parameter determining the measurement speed is the measurement time, which is entered as a numeric value. It is always rounded to an integer multiple of the measurement time of the used zoom FFT.

The minimum measurement time depends on the lower frequency limit selected. The lower it is set, the longer the measurement will take.

If a measurement time is entered which is longer than the minimum measurement time, several FFTs are averaged internally. Measurement inaccuracies are thus determined, on the other hand, short-time monitoring gaps occur which are usually not critical.

For long-time measurements, measurement times of up to 12 hours can be selected.

The measurement time also determines the update rate of the 12<sup>th</sup> octave analysis. Each time the selected measurement time elapses, the results are updated; no intermediate results are displayed.

Specified range:

ANLG 22 kHz:  $t_{meas_{FFT}} \dots 720 \text{ min (12 h)}$

DIGITAL:  $t_{meas_{FFT}} \dots 720 \text{ min}$

$t_{meas_{FFT}}$  = measurement time for a zoom FFT,  
depending on the lower frequency limit

Units: s | ms |  $\mu$ s | min

**Max Hold**

**OFF**  
**ON**

Hold function for the maximum result of each 12<sup>th</sup> octave. The function can be turned off. Reset by pressing the START key. Just like the measurement results of the individual frequency bands, the max-hold values can be displayed either graphically as horizontal markers in the spectrum or numerically in a spectrum list. They are available via auto and remote control. To present numerical results, switch on Scan #2 (PgUp or PgDn key). Graphically the maximum values are indicated by narrow horizontal lines at the top of the associated bars of the frequency bands.

Max-hold function switched off; only the bars of the bands are displayed.

Max-hold function switched on; the markers lie on the maximum values; corresponds to the "FOREVER" setting with third analysis. Reset only by starting the measurement (START key).

## Unit Ch1/2

(see 2.6.5.1 Common Parameters of Analyzer Functions)

## Reference

(see 2.6.5.1 Common Parameters of Analyzer Functions)

GEN TRACK cannot be selected with 12<sup>th</sup> octave analysis, since triggering is usually initiated by noise signals (e.g., pink noise), which generator tracking is not defined for.

## Filter

(see 2.7 Analyzer Filters (FILTER Panel))

Any standard or user-defined filter may be selected.

**UPL-B29:** *No filter may be switched on in high rate (see 2.15.9 Selecting the Sampling Mode).*

## FrqLim Low

Lower band limit for 12<sup>th</sup> octave analysis. The representation and calculation of the frequency bands start with the band containing the lower limit frequency. Any signals below the lowest frequency band will not be included in the calculation of the total rms value.

The lower the lower limit frequency, the narrower the frequency bands which will have to be measured. In order not to fall below a minimum amount of bins per band, the FFT resolution and thus the zoom factor of the FFT will have to be increased with narrower frequency bands

A zoom factor higher than 2 means on the other hand, that a single measurement will not be sufficient to cover the complete frequency range. In this case, 2 measurements are performed internally for the lower and the upper frequency range and the measured values of the single measurements are combined.

The lower limit frequency thus considerably influences the measurement speed which is why it should not be selected lower than required for the measurement task.

Optimum settings for the frequency range are, e.g (analog analyzer or DIGITAL 48 kHz)

- 410 Hz to any frequency
- 205 Hz to 11172 Hz

Specified range:

ANLG 22 kHz: 15.4 Hz to 20586 Hz

DIG 48 kHz: 15.4 Hz to  $f_{\max}$

$f_{\max}$  depends on the sampling rate and does not exceed 20586 Hz

**FrqLim Upp**

Upper band limit for 12<sup>th</sup> octave analysis. The representation and calculation of the frequency bands end with the band containing the upper limit frequency. Any signals above the top frequency band will not be included in the calculation of the total rms value.

FrqLim Upp conditionally affects the measurement speed (analog or DIGITAL 48 kHz):

- If the *lower limit frequency is above* 409 Hz, FrqLim Upp does not affect the measurement speed.
- If the *lower limit frequency is below* 409 Hz, the measurement speed is lower, if FrqLim Upp is higher than FrqLim Low + 10.97 kHz

Specified range:

ANLG 22 kHz: FrqLim Low to 20586 Hz

DIGITAL: FrqLim Low to  $f_{\max}$

$f_{\max}$  depends on the sampling rate and does not exceed 20586 Hz

**SPEAKER**

(see 2.6.6 Headphone/Speaker Output)

The input signals of channel 1 and/or channel 2 (without filter) can be monitored.

### 2.6.6 Headphone/Speaker Output

The Headphone/Speaker Output UPL-B5 permits to monitor both analog and digital measuring and test signals during the measurement. For this purpose, the built-in loudspeaker or the externally connected headphones are used. The impedance of the headphones should be 600 Ω so that a distortion-free operation is guaranteed even with full volume. When connecting headphones with lower impedance, distortions have to be taken into account depending on the power level. The maximum peak voltage at the headphones is 8 volts.

Principle of operation:

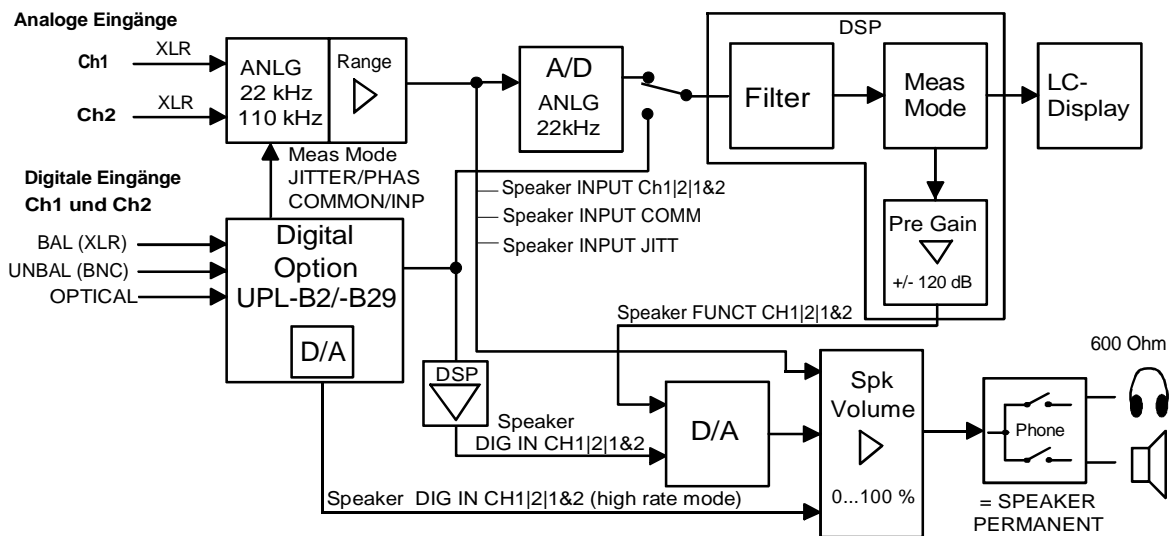

Fig. 2-28 Principle of operation of the headphones/speaker output

The input signals of all analog analyzers (INPUT) and the output signals of all analyzer level functions may serve as signal sources for the monitor output, in addition monitoring of THDN and Rub&Buzz residual signal can be switched on.

**UPL-B29:** Aural monitoring of residual signals is possible in the base rate mode only. In the case of option UPL-B29 in high rate mode, UPL-B5 variant 03 is necessary for aural monitoring. If high rate mode is active, aural monitoring is fundamentally possible at inputs, also with Analog Analyzer 22 kHz.

Table 2-37 Monitoring realized for the analyzer functions

Functions	Monitoring possible	Output signal =
RMS, RMS Sel, PEAK, Quasi PEAK	yes (not in the high rate mode)	Filtered or unfiltered input signal
THD+N, RUB&BUZZ	yes (not in the high rate mode)	Residual signal or unfiltered input signal
DC, THD, MOD DIST, DFD, WOW & FL, FILTER SIM, COHER, FFT, POLARITY, WAVEFORM, 1/3-Octave	no	Input signal

Pre Gain permits a signal variation of +/- 120 dB. This permits to boost even weak residual signals such that they can be monitored. If the AES/ EBU option is installed, the AES/EBU signal can also be monitored at the input (AES).

A level control (volume) permits setting of the volume. In the case of Phone SPEAKER, the internal loudspeaker is automatically switched off by connecting the headphones. In the case of Phone PERMANENT, only the loudspeaker is switched on and off using the Speaker-off key.

The Speaker menu is located at the end of the ANALYZER panel and linked to the measurement function, i.e. it is stored and loaded together with the function. Thus the monitoring output can be configured separately for each measurement function. For instance, a high preamplification is required for monitoring residual signals (THD+N, Rub&Buzz, RMS SEL with tracking bandstop filter) while a considerably lower preamplification is sufficient for (filtered or unfiltered) RMS measurements to avoid overdriving and excessive volumes.

To protect the user against excessive volumes (particularly when headphones are connected), the monitoring output is automatically switched off when SETUP settings are loaded, the analyzer instrument or a function is changed or the Speaker command is given. In this case the monitoring output has to be switched on again with the Speaker-off key (LOCAL key). If headphones are used, the Speaker menu should be checked prior to switching on to avoid excessive volumes increased through inadvertent gain setting ("Spk Volume", "Pre Gain").

**Note:** *The monitor output is designed as*

- *control output for monitoring the input signal by means of headphones or loudspeaker or for*
- *monitoring the signal using an oscilloscope, since analog signals from 20 Hz to 110 kHz can be monitored with a frequency response of  $\pm 0.2$  dB and digital output signals. Due to noise sidebands of the internal PLL of option UPL-B5, a THD + N measurement does not provide the excellent data usually supplied by the measuring path of the UPL (distortion  $\leq -60$  dB above the frequency range from 20 Hz to 110 kHz). However, these non-harmonic interfering signals are inaudible due to the psychoacoustic masking effect of the human ear.*

## ANALYZER panel

SPEAKER	Monitor output
OFF	Monitor output is switched off
INPUT Ch1	Monitoring the input signals of the analog analyzers ANLG 22 kHz and ANLG 110 kHz on channel 1. The signal is applied to both output channels.
INPUT Ch2	... on channel 2
INPUT Ch1&2	Monitoring the input signals of the analog analyzers ANLG 22 kHz and ANLG 110 kHz on channel 1 and channel 2 (stereo operation). If channel 1 or channel 2 are selected as analyzer input, only the left-hand or right-hand phones output can be monitored correspondingly.
DIG IN Ch1	Monitoring of the left channel of the digital audio interface of the digital analyzer DIGITAL (Digital Audio I/O Option UPL-B2 or UPL-B29)
DIG IN Ch2	... of the right channel.
DIG Ch1&2	... of both channels.
<p><b>Note:</b> <i>Monitoring of the digital audio signals is only possible if the Digital Audio I/O Option UPL-B2 or UPL-B29 is installed. Bei eingebauter UPL-B29 ist zum Mithören im High Rate Mode (siehe 2.15.9 Selecting the Sampling Mode) die Mithöroption UPL-B5 Variante 03 notwendig.</i></p> <p><b>If the high rate mode is switched on, monitoring is possible via the inputs only. This also applies to the 22 kHz analog analyzer.</b></p>	
FUNCT Ch1 FUNCT Ch2	Monitoring of the measurement function output of the analog analyzer ANLG 22 kHz for channel 1. If filters are switched on for the measurement function, the filtered signal (or the residual signal for THD+N, Rub&Buzz or RMS SEL) can also be monitored here.
FUNCT Ch1&2	... channel 2.
INPUT JITT	... both channels (stereo operation).
INPUT COMM	Available only in the DIGITAL analyzer with Digital Audio I/O option (UPL-B2 + UPL-B22) in Meas Mode JITTER/PHAS. The demodulated jitter signal is applied to the ANLG 110 kHz analyzer and can be listened to.
	Available only in the DIGITAL analyzer with Digital Audio I/O option (UPL-B2 + UPL-B22) in Meas Mode COMMON/INP. The superimposed common-mode signal at the digital inputs is applied to the ANLG 110 kHz analyzer and can be listened to.

## Pre Gain

For the menu items SPEAKER FUNCT CH1/2/1&2 a gain or attenuation of the function output can be set in the range  $\pm 120$  dB. If the gain is set too high, the signal is limited at the monitor output.

## Spk Volume

Volume for the monitor output, settable from 0 to 100%

## Phone

Configuration of the monitor output at the phones connector.

## = SPEAKER

When connecting the headphones, the internal loudspeaker is automatically switched off.

Phones output is operated in conformance with the loudspeaker, i.e. the Speaker-off key (LOCAL key) switches off the internal loudspeaker or phones output. The monitor signal sounds either from the built-in loudspeaker or from the connected headphones.

## PERMANENT

Phones output is permanently switched on. Speaker-off key only acts on the internal loudspeaker irrespective of whether the headphones are connected up. In this case, the internal loudspeaker also remains active with the headphones inserted.

Keys for speaker control:

LOCAL key



This key is used to switch on/off the internal loudspeaker in local mode of the UPL (Speaker-off key). In remote mode, the first keystroke switches to the local mode.

+ / key



This key opens a box for faster setting of the monitoring volume (Spk Volume).

### Example of application: Monitoring the distortion of a signal

In the UPL, the signal distortion can be monitored either directly when a THD+N measurement is performed or by switching on a narrow bandstop filter in the case of an RMS SELECT measurement.

When a **THD+N measurement** is performed, the signal to be monitored is routed via a digital filter or a second (analog) notch filter. The frequency of the signal is permanently monitored and the notch filter immediately fine-tuned, if required. In this case the monitoring output is briefly muted.

Depending on the selected generator and the quality of the test signal, a different setting is required for menu items "Fundamental" and "Dyn Mode":

- Internal universal generator (Low Dist → OFF)

Select Fundamental → GEN TRACK; the dynamic mode is arbitrary. When the generator frequency is changed, the internal notch filters are automatically tuned to the new fundamental.

- Internal low-distortion generator (Low Dist → ON)

Select Fundamental → AUTO. (When the low-distortion generator is switched on, GEN TRACK is ignored and handled internally in the same way as AUTO.) This is to avoid the generator frequency being slightly outside the stopband range of the two notch filters. The dynamic mode PRECISION may be selected if the signals to be measured are only slightly distorted or noisy.

- External generator:

Select Fundamental → AUTO. The signal frequency is permanently monitored and the internal notch filter fine-tuned, if required. Select the dynamic mode PRECISION or FAST depending on the signal quality.



**Note** on monitoring the residual signal during the THD+N measurement:

- The monitoring output is muted for approx. 1 s every time a change is made in the GENERATOR or ANALYZER panel before the THD+N measurement is (re)started or when the notch filter is internally tuned. This is not a malfunction but should protect the listener against clicks and noise while the settings are made, which would be very disturbing because of the high gain of the residual signal.
- If external signal sources are used, it cannot be avoided for the fundamental to go outside the stopband range of the notch filter and being applied with high level to the monitoring output whenever the frequency is changed. As soon as the THD+N measurement routine identifies a new fundamental, the monitoring output is muted and the notch filter adjusted.

**Remedy:**

- This effect can be avoided through the use of an internal generator.
- If an external generator has to be used, the following procedure is recommended:  
Stop or abort the current (permanent) measurement using the STOP or SINGLE key, then set the external generator and restart the measurement with the START key.
- If the time of the generator switchover cannot be predicted, a short measurement time should be selected to minimize the period before the signal is muted.
  1. Reduce Meas Time SUPERFAST or the FFT size (with post-FFT switched on).
  2. Switch post-FFT OFF.
  3. Switch result display off.
- If the loudspeaker is not switched on again after muting although Speaker was neither switched off by means of the PHONE OFF key nor via the Speaker menu, it could be that the measurement routine cannot find a reliable and sufficiently strong signal.

**Remedy:**

- Switch off the analog notch filter by selecting the dynamic mode FAST or
- Fundamental GEN TRACK, provided the internal universal generator is used.
- If the signal to be measured contains considerable noise or strong harmonics, it could happen that the fundamental after the analog notch filter cannot be detected.

**Remedy:** as above

- Any kind of DC (DUT, DC offset of notch filter ) may cause the monitoring output to be overdriven and muted.

**Remedy:**

- Perform or switch on a DC offset calibration in the OPTIONS panel.
- Switch on the highpass filter (Filter →HP...),
- Switch on AC coupling (Couple CHx→ AC).

If an **RMS SELECT measurement** is performed, the distortion can be monitored by cutting in a narrow bandstop filter. The frequency of the bandstop filter can be permanently set or automatically adjusted when the frequency is changed in the GENERATOR panel.

The DUT is connected, for instance, between analog generator input 1 and analog analyzer input 1. Settings on the UPL:

Load the UPL default setting in the FILE panel.

```
LOAD INSTRUMENT STATE
Mode          DEF SETUP
```

Settings in the UPL ANALYZER panel:

```

ANALYZER
┌───┴───┐
J FUNCTION - RMS SELECT ▲
J Meas Time GEN TRACK
- Unit Ch1 U
- Reference GEN TRACK
J Bandwidth BS 1/12 OCT
J SWEEP CTRL OFF
J FREQ MODE GEN TRACK
J Factor 1.0000 *
- Sweep Sync NORMAL
J Notch(Gain) 0 dB
J Filter OFF
J FncT Sett1 OFF

J SPEAKER — FUNCT CH1
J Pre Gain 70.000 dB
J Spk Volume 100.00 %
J Phone Out = SPEAKER

```

With FREQ MODE GEN TRACK, the bandstop center frequency follows the frequency setting in the GENERATOR panel.

FREQ MODE FIX holds the bandstop frequency irrespective of the generator frequency.

With NOTCH(Gain) 0 dB, an analog notch filter is switched on which increases the stopband attenuation by another 40 dB (in addition to the 100 dB attenuation of the bandstop filter).

Switch on loudspeaker: press Speaker off key (LOCAL key) or open volume box (+/- key) and adjust the desired volume.

By setting Pre Gain, the residual signal can now be boosted above the audible level.

Depending on the distortion of the DUT, the harmonics of the test frequency can be clearly distinguished from the noise.

Depending on the selected generator, menu items Bandwidth and FREQ MODE can be set in different ways:

- Internal universal generator (Low Dist → OFF)

Select FREQ MODE → GEN TRACK; the set bandwidth may be as narrow as desired (Bandwidth → BS 1%) because the universal generator features a very high frequency stability. When the generator frequency is varied, the fundamental is automatically suppressed by the tracking bandstop filter.

- Internal low-distortion generator (Low Dist → ON)

When the low-distortion generator is used, which features a high spectral purity but a slightly reduced frequency stability, it may happen that the generator frequency is slightly outside the bandstop filter range BS 1% and the fundamental is not completely suppressed. *Remedy:* Select

- a wider bandstop filter (bandwidth → BS 3%, BS 1/3 OCT, BS 1/12 OCT) *or*
- FREQ MODE → FIX and tune the center frequency manually to the generator frequency or, the other way round, vary the generator frequency by a few Hz so that the fundamental is optimally suppressed.

- External generator:

Select FREQ MODE → FIX and tune the center frequency as accurately as possible to the generator frequency. For generators with a non-stabilized frequency, a wideband bandstop filter should be selected in addition (bandwidth → BS 3%, BS 1/3 OCT, BS 1/12 OCT).

**Note** on monitoring the residual signal during the RMS selective measurement:

*Any kind of DC (DUT, DC offset of notch filter) may cause the monitoring output to be overdriven and muted.*

**Possible remedies:**

- Perform or switch on a DC offset calibration in the OPTIONS panel.
- Switch on highpass filter (Filter → HP...),
- Switch on AC coupling (Couple CHx → AC).

## 2.6.7 Applications

### 2.6.7.1 Crosstalk Measurement

Crosstalk means the -undesired- coupling of signals of one channel to another communication channel. It is usually indicated as a function of the frequency. It is measured by modulating one channel by means of measuring the amplitude in the unmodulated channel. Since the coupled signals are normally low and may correspond to the signal-to-noise ratio, the full dynamic range should be used. The values are indicated in dB, the output amplitude of the modulated channel being used as reference.

- Basic setting

The generator is set to SINE and a frequency sweep is activated. Since crosstalk normally does not reveal steep variations over the frequency, approx. 20 to 30 test points with logarithmic spacing are sufficient in the range from 20 Hz to 20 kHz. VOLTAGE is set such that the maximum voltage is reached at the DUT output.

The RMS & S/N (with S/N Seq OFF) function is used in the analyzer to measure the level with AUTO or AUTOFAST mode. This is a two-channel measurement, i.e., Channels(s) is set to 2=1. Range AUTO matches the different levels automatically. INPUT DISP and FREQ/PHASE measurements should be switched OFF to increase the measurement speed.

Since the measurement is to be displayed as CURVE PLOT, operation is set accordingly in the DISPLAY panel. Scan count is set 1. Scale B is selected NOT EQUAL A. Unit should be set to dB in both channels and the normalize value to 1.0 \* or 0 dB.

- Measuring crosstalk from CH2 to CH1

The generator setting is "Channel(s) 2" in order to switch on channel 2. In the DISPLAY panel, Trace A is set to FUNC CH1 and reference to MEAS CH2. Trace B is OFF. -Pressing the SINGLE key starts the first measurement sequence.

- Holding the measurement

Since the same display shall contain crosstalk of the other channel, the first measurement must be "held" by selection of the setting Trace A HOLD. If AUTO ONCE has not yet been selected for Scale, the automatic scaling can now be initiated.

- Measuring crosstalk from CH1 to CH2

In the GENERATOR panel, Channel(s) 1 is selected in order to switch on the other channel. Trace B is set to FUNC CH2 and MEAS CH1 is selected as reference. Pressing the SINGLE key starts the 2nd sweep.

- Post-processing/storage

Since the crosstalk values of the individual channels do normally not deviate considerably from each other, the scaling of TRACE A can be copied using Scale B EQUAL A.

The complete measurement can then be stored in a file by entering Store TRACE A+B and a file name in the FILE panel. Besides, a screen hard copy can be selected for documentation purposes and output by pressing the HCOPY key in the OPTIONS panel.

- Copying the functions to be executed in the STATUS panel

This measurement is a typical application for the STATUS panel. The few command lines to be executed can be copied into the common STATUS panel by marking them in order to avoid manifold switchover between GENERATOR and DISPLAY panels (cf. 2.8 STATUS panel). Assuming that nothing

has been marked, the Channel(s) command is ticked off in the GENERATOR panel and the lines TRACE A, Reference (A), TRACE B, Reference (B) and Scale B, if required, are ticked off in the DISPLAY panel.

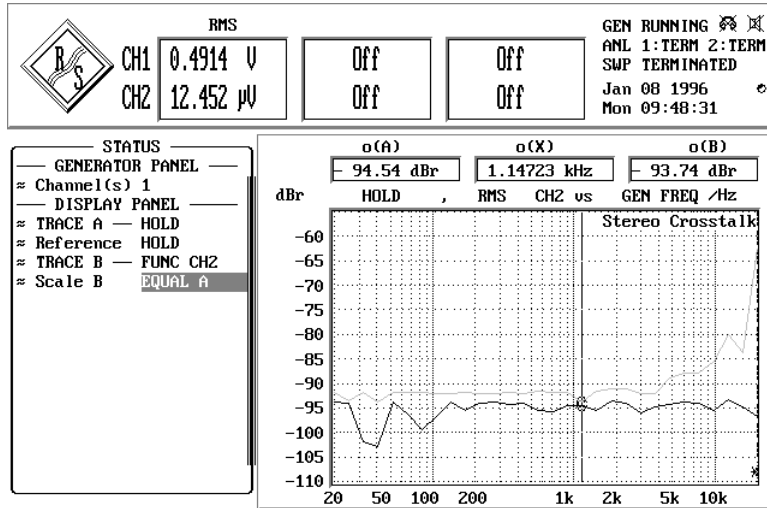

Fig. 2-29 STATUS and GRAPHICS panels with crosstalk measurement

### 2.6.7.2 Linearity Measurements

In linearity measurements the output level is plotted versus the input level. The unit normally used is dBr but V/Vr can also be selected. If a fixed reference value is used, a straight rising line is obtained. To accentuate departures from linearity, a straight horizontal line would be desirable. This line is obtained when the measured values are not referenced to a fixed value but to the input frequency.

The UPL does not offer a separate function for linearity measurements. Such measurements are defined as a special reference of the level measurement. This offers the following **advantages**:

1. Linearity measurement not confined to one single measurement function. *All level measurements* (RMS, RMS select, quasi-peak and all peak measurements) can be used for linearity measurements.
2. Switchover between linearity measurement and (absolute) level measurement is effected by selecting the unit (menu line "Unit 1" or "Unit 2"). It is thus possible to display the linearity measurement in one channel and the absolute level in the other.
3. By selecting the reference (menu line "Reference"), a switchover is made between a fixed or a floating reference (linearity measurement). Thus the linearity measurement can be displayed in one channel and the level referenced to a fixed value in the other.

**Note:** *The reference used for linearity measurements is defined as "floating reference value" in this manual. In contrast to the commonly used fixed reference, each measured value has a reference value of its own.*

The linearity measurement can be performed by means of a sweep. Measured values can be numerically or graphically displayed in the GRAPHICS panel and normalized. Moreover, the nonlinearity of each measured (level) value can be directly read from the result window without a sweep being set and performed.

Either the internal generator (GEN TRACK) or - when both channels are switched on - one of the two measurement channels (MEAS CH 1/2) can be selected as a reference for the linearity measurement. A measurement channel has to be selected as a reference when an external generator is used or if reference is to be made to a specific point in the test setup.

**Note:** *A two-channel linearity measurement assumes that neither of the measurement channels is needed as a reference. With MEAS CH1 or MEAS CH2 selected as a reference, the linearity measurement can be performed in one channel only. Being referenced to itself, the other channel yields 0 dBr.*

More possibilities are available when the measurement is carried out in the form of a sweep with the result displayed in a graphics window:

1. When stored as a trace file, the level curve of a reference item (golden unit) can be selected as a reference under FILE in the DISPLAY panel. Thus departures from linearity can be displayed with a reference to this golden unit without the latter being available for the measurement.
2. The level curve measured in the other trace (or loaded from a file) can be directly selected as a reference in the DISPLAY panel (OTHER TRACE). Thus it is possible to subsequently reference the absolute level curves of the two channels to each other.
3. The sweep shows the linearity deviation (e.g. in dBr) from the selected reference curve. This deviation is not necessarily around 0 dBr. If the DUT has a gain or loss, the deviation may be above or below this value. The gain factor of the DUT can be compensated for by a scaling factor which can be entered either numerically or by means of an automatic 0-dB scaling to the current cursor position.

**Note:** When measuring D/A or A/D converters using the internal UPL generator, the linearity measurement (with GEN TRACK) leads to the physical problem of referencing an analog voltage to a digital one (or vice versa). UPL internally calculates with a **conversion factor** of

$$\boxed{1V / 1FS \text{ or } 1FS / 1V}$$

Same as the gain factor, this conversion factor can also be compensated for by the scaling factor.

**1-channel linearity measurement referenced to measurement channel 1:**

1. Select analyzer (ANLG 22 kHz or ANLG 110 kHz) according to the required frequency.
2. Select a level measurement (RMS, RMS select, quasi-peak or peak) and, if necessary, the measurement mode suitable for the measurement task.
3. If a curve is to be swept, further settings have to be made in the DISPLAY panel: Operation must be set to Curve Plot, FUNCT CH2 should be selected for trace A and trace B should be OFF.
4. Select dBr or V/Vr for channel 2 and trace A (in the ANALYZER and, if required, the DISPLAY panel).
5. Select MEAS CH1 as a reference (menu line REFERENCE in the ANALYZER and, if required, in the DISPLAY panel). The measurement result of channel 2 is then referenced to the input of channel 1.
6. The linearity deviation is displayed in the result display of channel 2 with the selected unit. On triggering a (SINGLE) sweep, the linearity characteristic is graphically displayed versus the input level.

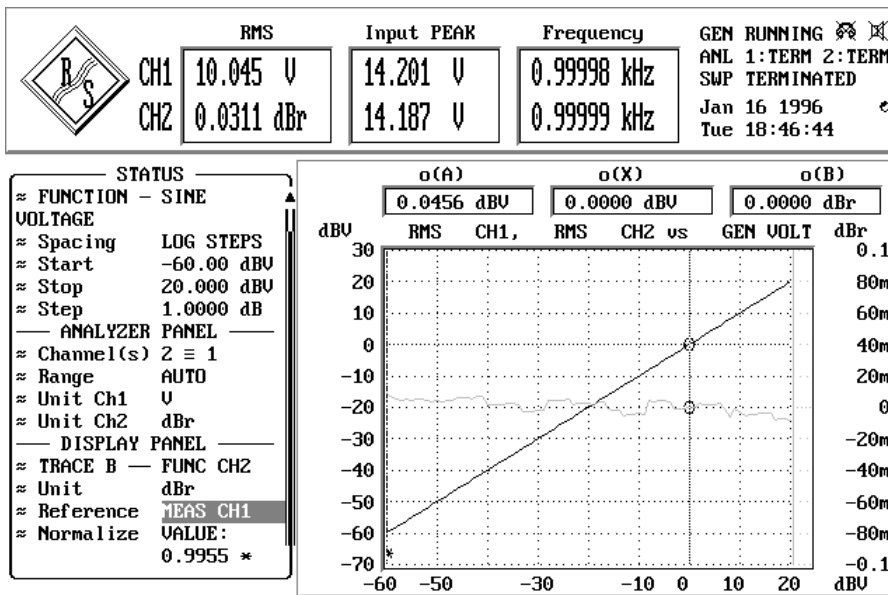

Fig. 2-30 Configuration of UPL for linearity measurement referenced to channel 1, the linearity characteristic being displayed on trace B, the absolute reference channel on trace A.

**2-channel linearity measurement referenced to internal generator:**

1. First configure and set the internal generator (sinewave signal, level sweep, signal frequency, etc.).
2. Select analyzer (ANLG 22 kHz or ANLG 110 kHz) according to the required frequency.
3. Select a level measurement (RMS, RMS select, quasi-peak or peak) and, if necessary, the measurement mode suitable for the measurement task.
4. Further settings are to be made in the DISPLAY panel: Operation must be set to "Curve Plot", FUNCT CH1 should be selected for trace A and FUNCT CH2 for trace B.
5. Select the unit dB or V/Vr for both channels and both traces (in the ANALYZER and DISPLAY panels).
6. Select GEN TRACK as a reference (menu line REFERENCE in the ANALYZER and DISPLAY panel). Both measurement inputs are now referenced to the set generator level.
7. The linearity deviation is shown in the result displays with the selected unit. On triggering a (SINGLE) sweep, the linearity characteristics of both channels are displayed versus the generator level.

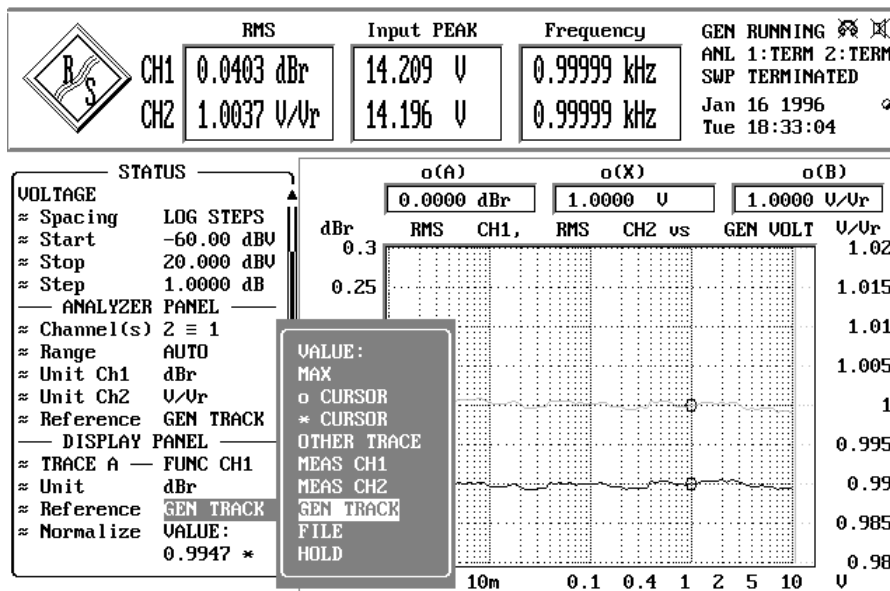

Fig. 2-31 Configuration of UPL for 2-channel linearity measurement referenced to the internal generator; display of linearity curve of both channels

After termination of the sweep, the swept curves can be normalized to one (or two different) points (e.g. 1 V). In this case the curve is vertically shifted so that it crosses the 0-dBr line at the selected reference points:

1. Switch over to the GRAPHICS panel (GRAPH key or ALT+R). Activate one or both graphics cursors, if required.
2. Move the cursor(s) to the desired reference point(s).
3. Return to the DISPLAY panel (DISP key or ALT+D).
4. Open the menu item Normalize of Trace A, select O-Cursor or \*- cursor, depending on which one was used for marking the reference point.
5. If required, repeat step 4 for Trace B.

**Note:** If the linearity characteristic is to be determined at various frequencies, this can be realized by means of the two-dimensional sweep (with frequency on the Z axis). The individual curves overlap in the display and yield a set of curves.

### 2.6.7.3 Fast Frequency-Response Measurements

Usually, frequency-response measurements are performed using (generator) frequency sweeps and RMS measurement. Although the UPL offers a very high RMS measurement speed (approx. 15 ms per measured value), such a sweep may lead to a total measuring time, which is unacceptable due to the large number of sweep steps to be performed. In other words faster modes are called for.

A combination of the FFT function and the generator signal RANDOM, Domain FREQ would be an alternative. The generator can be synchronized to the spacing of the analyzer, i.e. each generated frequency line of the (pseudo) random signal is assigned exactly one line of the FFT. Thus FFT windowing can be omitted and a maximum frequency and level accuracy is obtained.

After outputting the generator random signal, all measurements can be performed at the speed of a single FFT. Thus, the measurement speed only depends on the FFT size, which should be selected so that the desired (linear) frequency resolution is just obtained.

**Note:** *Logarithmic spacing is not possible with FFT; irrespective of this, logarithmic scaling of the X axis can be selected in the DISPLAY panel.*

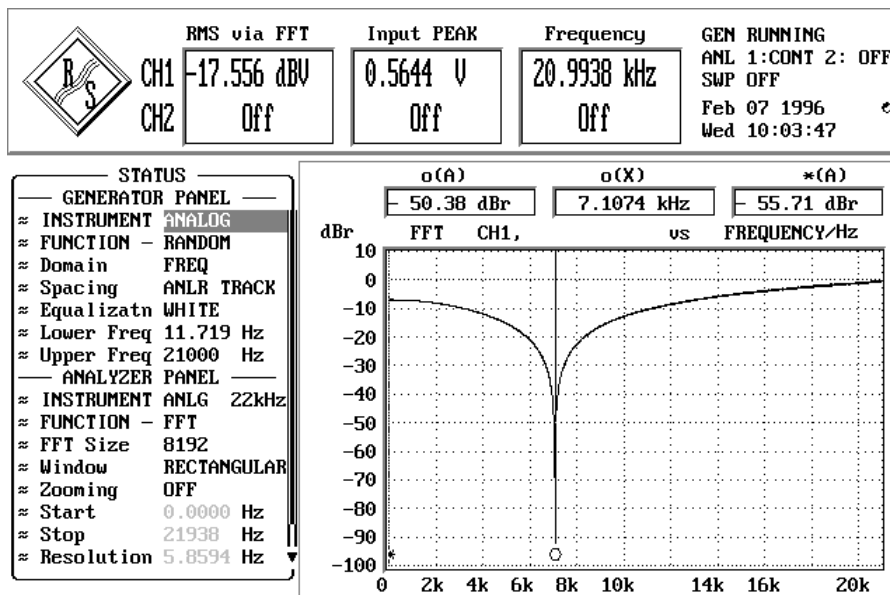

Fig. 2-32 Configuration and result of fast frequency-response measurement



## 2.6.8 Optimizing the Measurement Speed

A high measurement speed is of particular importance for remote control as the measurement time directly influences the program run time. For this reason program sequences are given in Section 3.15.10 Tuning - Setup for Maximum Measurement Speed, to optimize the measurement speed in the case of remote control.

Short measurement times are also desirable in manual operation, particularly for sweeps and FFT, in order to obtain a real-time characteristic (e.g. for tuning procedures). For this reason a few general hints will be given below on how to cut down on the available measurement time. Optimization measures can be classified in 4 groups:

1. Speed optimization *without affecting* the measurement accuracy
2. *Compromise* between measurement time and accuracy or dynamic
3. Speed optimization through use of *internal* generator,
4. Optimizing the sweep speed
5. Optimales Ausnutzen der DSP-Performance abhängig von der Taktrate

A brief form of these hints is available in the UPL online help functions (see 2.3.7 Help Function) under the item "Optimization".

### 1. Speed Optimization without Affecting Measurement Results

- Selecting a suitable analyzer instrument (analog measurement signals only)  
In the ANLG 22-kHz instrument, the two channels can be measured in parallel (synchronously) already during sampling. This analyzer also offers a wider conversion range and a lower frequency limit and should therefore be used in all cases where an upper measurement limit of 22 kHz is sufficient.
- Switching off unused measurement inputs  
An unused measurement input may considerably extend the measurement time as a measurement is only terminated when a measured value is available for the unused input too. Some measurement functions (e.g. RMS with automatic measurement time, THD+N) require a much longer time for measuring low signal levels (noise) but even if a signal is present on channel 2, the measurement time is certainly longer than in the case of 1-channel operation, as also the 2nd channel has to be completely evaluated and displayed. In the ANLG 110-kHz instrument the two channels are measured sequentially so that the measurement time is at least twice as long.
- Switching off the "Beeper"  
In the setting "Beeper ON" there is a short sound of several 100 ms duration after each (single) sweep which indicates the sweep ending. During this time no device activities are possible. Especially with short sweeps this dead time is disturbing. Therefore the Beeper function should be switched off while sweeps are running - especially under remote/automatic control - if no acoustic reply of sweep end is required.
- Switching off unused result displays  
If the result displays for FREQUENCY and INPUT DISP are not required they should be switched off. In addition to saving the time required for evaluation and display of these values, some measurement functions (e.g. RMS) can be terminated more quickly.
- Switching off settling functions  
For most signals the settling function is not required. If the DUT provides a stable signal, the UPL yields settled values even without the settling function. Settling (or averaging) multiplies the measurement time by at least the number of the set samples (see 2.3.4 Settling Process).

- Switching off filters that are not required  
Each (digital) filter increases the total measuring time because of its settling time. Unused filters should therefore be switched off in the ANALYZER panel.
- Switching off the measurement delay function ("Delay" under START CONDITION)  
With the aid of this function DUT delays can be corrected. The start of the 1st measurement and consequently of each sweep point are delayed for a defined period each time the generator or analyzer setting is changed. If a start delay is not required, this time should be set to 0.0 (see 2.6.4 Ways of Starting the Analyzer, Ext. Sweep).
- Manual selection of analyzer level range (analog measurement signals only)  
If the level of the signal to be measured is known and a limited measurement range can be accepted, the analyzer level range should be manually selected (Range FIX). A range corresponding to the highest expected level should be set, an UNDERRANGE being taken into account. This prevents a new measurement with a corrected range setting to be performed. To ensure that the measurement will not be falsified by a higher signal level, "Range LOWER" may be selected. With this mode selected the measurement function is able to correct the measurement range in the case of OVERRANGE (see 2.6.2 Configuration of the Analog Analyzers).

## 2. Compromise between Measurement Time and Accuracy or Dynamic

The methods below can only be used with certain measurement functions.

- Selection of low measurement dynamic (dynamic mode FAST, for analog measurement functions THD, THD+N/SINAD, DFD, MODDIST only).  
If signals not making full use of the UPL dynamic range are to be measured, e.g. distortion above 0.1%, precision measurements are not required. Consequently, the measurement time can be reduced by about a factor of 2 without any loss in accuracy.
- Reducing the FFT size for FFT and THD+N  
Halving the FFT size also halves the measurement time required for FFT. This also applies to FFT-supported measurement functions like THD+N and SINAD.  
In the case of THD+N/SINAD measurements, reducing the FFT size does not only reduce the time required for (post)-FFT but also the THD+N/SINAD measurement time, irrespective of whether post-FFT is activate or not. This however is at the expense of the measurement accuracy. (see 2.6.5.7 THD+N/SINAD).
- Reducing the numeric value of "Measure Time" for RMS, RMSSEL, PEAK, QPEAK and DC  
If a fixed measurement time is used, the desired time can be directly entered as a numeric value. Entering a shorter measurement time reduces the measurement accuracy. The measurement time is defined for each single measurement. With AUTO ranging selected, a new measurement performed because of an unfavorable (UNDERRANGE) or incorrect (OVERRANGE) level range leads to a total measurement time which exceeds the desired one.
- Selecting AUTO FAST for RMS and RMSSEL  
Automatic selection of the measurement time in the case of RMS measurements ensures that the shortest possible measurement time is selected for the desired accuracy (AUTO or AUTO FAST) in the case of unknown signals irrespective of the test frequency. If an accuracy of 1% is sufficient, AUTO FAST should be used (see 2.6.5.2 RMS).
- Extending the span for zoomed FFT  
The span for zoomed FFT should not be smaller than that required by the necessary frequency resolution. Doubling the span halves the frequency resolution and the measurement time (see 2.6.5.12 FFT).

- Increasing the bandwidth for RMSSEL  
The larger the band of the digital bandpass or bandstop filter, the shorter the measurement time. The measurement can be speeded up if a reduced selectivity is sufficient for the signal frequency (see 2.6.5.3 RMS SELECT).
- Reducing the attenuation and/or the edge steepness of user-defined filters  
Both measures reduce the settling time of the filters and thus the measurement time (see 2.7.2 Creating the User-definable Filters).
- Reducing the order of user defined high and low passes  
By this measurement too the response time of the filter and consequently the measurement time is reduced (see 2.7.2 Creating the User-definable Filters).
- Deactivating the analyzer frequency response calibration with frequency response measurements  
When using the measurement function rms ("Meas Time" *not* GEN TRACK) the frequency response calibration can be switched off thus reducing the linearity accuracy. This is implied when switching off the frequency measurement
- Deactivating the generator frequency response measurement  
The generator frequency response calibration can be switched off by means of deleting and renaming the "C:\UPL\REF\FLAT\_GEN.CAL" file and restarting the UPL, subsequently. This procedure is more convenient if UPL-B10 option is installed by means of calling the BASIC macro FLAT\_GEN.BAS (in C:\UPL\USER).

### **3. Speed Optimization Through Use of Internal Generator**

- Selection of GEN TRACK modes, if available (RSM, RMSSEL, THD, THD+N/SINAD).  
With "Meas Time GEN TRACK" selected for RMS and RMSSEL, the measurement time can be exactly set to integral periods of the set generator frequency. The generator frequency can then be slightly modified (see 2.6.5.2 RMS).  
With "Fundamental GEN TRACK" selected for RMSSEL, a preliminary measurement for determining the frequency is not required. (see 2.6.5.3 RMS SELECT).  
With "Fundamental GEN TRACK" selected for THD+N/SINAD, the 1st FFT is performed with the correct resolution even if the selected FFT size is too small. In the case of low frequencies and a small FFT size, the measurement speed is almost doubled (see 2.6.5.7 THD+N/SINAD).  
Selecting "Fundamental GEN TRACK" for a pure THD measurement does not noticeably increase the measurement speed. Since an accurately defined fundamental is required for the THD measurement, "Fundamental AUTO" should be used.
- Fast frequency-response measurement possible  
If the harmonics generator ("Domain FREQ", "Shape FILE") is synchronized to the FFT analyzer, a highly accurate real-time frequency analysis can be performed. (see 2.6.7.3 Fast Frequency Response Measurement).

### **4. Optimizing the Speed of Generator Sweeps**

- To perform a frequency sweep 'Sweep Mode' (in analyzer panel) should be set to FAST or BLOCK - if available.

On certain conditions sweep velocity can be considerably increased:

- Selection of generator function SINE
- Use of universal generator, that is Low Dist OFF
- automatic frequency sweep without Z-sweep, that is X-Axis FREQ, Z-Axis OFF

- Selecting the universal generator instead of the low-distortion or analog auxiliary generator

Since the universal generator is superior regarding frequency setting time and frequency accuracy than the low-distortion generator it should preferably be used as a sweep generator. The low-distortion generator should only be used if its wide frequency range and excellent distortion and S/N ratio are required.
- Deactivating equalization of generator signal (SINE and DFD)

With activated signal equalization the level has to be reset each time the frequency is changed. This extends the total setting time and thus the sweep time. For this reason equalization should be switched OFF in the case of very fast sweeps (see 2.5.4.1.3 Equalization of SINE, SINE BURST, DFD, MULTISINE, RANDOM).
- Synchronizing the generator to the analyzer (next step ANLR SYNC)

When the UPL generator and analyzer are used together, a generator sweep should always be synchronized to the analyzer. Thus it is ensured that the generator is switched exactly at the time when all measurement results are available (i.e. also frequency and input on the active channels, if required).

DWELL should only be used together with an external analyzer (see 2.5.4.2 Sweeps).
- Manual selection of generator level range (only for analog level sweeps using the universal generator)

When a reduced dynamic range can be accepted for the generator, selection of the fixed generator level range and generator setting time as well as the settling time can be shortened (see 2.5.2 Configuration of the Analog Generator).
- Reducing the measurements at low frequencies (particularly for RMS, RMSSEL and THD+N)

==> linear instead of logarithmic spacing,  
==> increasing the start or (in the case of a sweep "from top to bottom") the stop frequency.

Low frequencies require longer measurement times. For this reason too many unnecessary sweep points should be avoided in the lower frequency range.
- Reducing the sweep points or increasing the spacing, list sweep

The time required for a sweep increases linearly with the number of sweep points. Unnecessary sweep points should be avoided. In the case of a list sweep the individual sweep points can be spaced as required and sweep points may be concentrated at positions of interest without substantially increasing the total number of sweep points (see 2.5.4.2 Sweeps).
- Switching off the result display and the status information

In the case of sweeps, the output of individual results in the result display is mostly unnecessary or even useless particularly when the results are indicated with a high update rate. The same applies to the status information. For this reason the two displays can be switched off (together). This elimination of the output time - irrespective of the required measurement time - is particularly noticeable in the case of very fast sweeps (see 2.15.5 Display Settings). The measurements can still be followed by means of the sweep curve or the bargraph display. The complete sweep list can be displayed in the graphics panel whenever required. (see 2.10.4 Display of Lists).
- Switching off the graphic cursor

For most applications display and update of the cursor values are not required while running sweep. Only the terminated sweep is analyzed by means of graphic cursors. Therefore the graphic cursors can be switched off during the sweep run and so the sweep time can be reduced (see 2.10.2 Trace and Spectrum Display).

## 5. Optimized Utilization of DSP Performance with the Clock Rate

The higher the clock rate of the test signal or the signal to be generated, the smaller is the performance margin of the DSPs in UPL. This may have three different effects:

1. The DSP cannot cope with the high clock rate and samples are lost.
2. The DSP cannot complete all its jobs in realtime, so subsequent processing becomes necessary.
3. The DSP cannot process the two measurement channels in parallel, so multiplex operation becomes necessary.

The effect under 1 must be avoided under all circumstances. The UPL analyzer and generator ensure clock rates up to 55 kHz in the BRM (base rate mode) and clock rates up to 106 kHz in the HRM (high rate mode). If an external digital signal is applied, the user must ensure the signal clock frequency to be within the specifications of the sample mode used.

The selection of HRM leads to a higher performance margin allowing the processing of higher clock rates. In HRM, measurement functions involving high computation effort therefore have to be performed offline (as under 2) or sequentially (as under 3).

Multiplexing reduces the measurement speed of the following functions (group 1) for two-channel measurements:

- Selective RMS
- RMS with filter with AUTO/AUTO FAST as measurement time
- Peak
- Quasi peak

The following measurement functions (group 2) require longer time for the subsequent processing in two-channel operation:

- Zoom FFT
- THD+N/SINAD
- MDIST
- DFD

All other measurement functions (group 3) are performed with the same speed in HRM as in BRM.

From the above, the following **guidelines for using base rate mode and high rate mode** may be derived:

- For exclusively analog measurements (AA), BRM should be used.
- For measuring / generating digital signals with clock rates above 55 kHz, HRM must be activated.
- Digital signal above 55 kHz or with an unknown clock rate should only be applied with HRM switched on.
- If HRM is switched on, longer measurement times are needed for two-channel measurements in group 2 and especially in group 1. Two-channel operation should therefore be switched on only if both channels actually have to be measured.

### 2.6.9 Improving the Frequency Response

The analyzer of the UPL is generally equipped with a frequency response calibration for rms measurements which compensates for the systematic frequency response errors of the internal components. To activate the calibration it is required that the frequency measurement is switched on with rms measurements or "Meas Time" set to GEN TRACK.

If – for measurements with built-in universal generator - the frequency response is to be further improved, the remaining frequency response of the analyzer in conjunction with the generator frequency response can be smoothed additionally by means of an instrument-specific equalization file.

To create this equalization file ("FLAT\_GEN.CAL" under C:\UPL\REF), a BASIC program FLAT\_GEN.BAS is supplied on the "SETUP/EXAMPLES" disk and loaded into the directory "C:\UPL\USER" with installation. It may be started as a macro, if the UPL-B10 option is installed. The equalization file can also be created manually using the "FLAT\_GEN.SAC" setup.

The generator frequency response correction should *not* be used in the following situations:

- whenever a maximum setting speed of the generator is required. The correction increases the time for setting a new generator frequency since the frequency and the level, in addition, have to be set. The time for a frequency response measurement with generator sweep increases with correction switched on by less than 10 %.
- if the generator is to be operated together with an external analyzer. Since the created equalization file also contains the inverted residual frequency response of the analyzer, the generator frequency response could be limited in the worst case. Verschlechterung des reinen Generatorfrequenzgang kommen.

The generator frequency response correction can be switched off again for the reasons described above. This is effected by the macro FLAT\_GEN.BAS or manually by deleting or renaming "C:\UPL\REF\FLAT\_GEN.CAL" file and subsequently restarting the UPL.

## 2.7 Analyzer Filters (FILTER Panel)

The FILTER panel has been devised for definition of the filters which can then be used in the ANALYZER panel. Before you can select a user-definable filter in the analyzer, you must, of course, create it in the FILTER panel.

### Activating the FILTER panel:

UPL front panel: FILTER

External keyboard: ALT + T

Mouse: (repeated) click on the right panel name, until the FILTER panel is displayed.

If the FILTER panel is already visible on the screen, it can be activated also by actuating one of the TAB keys (repeatedly) or by mouse-click.

Advantage: The panel need not be established again.



For the functions

- RMS & S/N (rms measurement) → 3 filters possible
- PEAK & S/N (peak measurement), → 3 filters possible(\*)
- Q-PK & S/N (quasi-peak meas.) → 3 filters possible(\*)
- THD+N/SINAD (distortion measurement) → 1 filter possible
- RMSSEL (selective RMS measurement) → 1 filter possible
- FILTSIM (filter simulation) → 3 filters possible
- RUB & BUZZ (loudspeaker measurement) → 2 filters possible
- WAVEFORM → 1 filter possible(\*)
- 1/3-OCTAVE → 1 filter possible(\*)
- FFT → 3 filters possible (\*)

any desired filters from the filter selection window can be set in the ANALYZER panel. This window contains user-definable filters (the first 9) and weighting filters, which are referred to by their short names in the FILTER panel or by a name complying to the standard. You can select any desired filter (also several times) and assign to the ANALYZER measurement function.

The sum frequency response of all selected filters can be graphically displayed using the analyzer function FILTSIM (see 2.6.5.13).

**UPL-B29:** *For the functions marked (\*), no digital filter can be switched on in the high rate mode or in the ANLG 110 kHz analyzer. When switching from base rate mode to high rate mode with these functions being active, all filters are switched to OFF and the filter menu lines removed from the analyzer panel. When switching back to the base rate mode, the menu lines are displayed again while the filters remain switched off.*

**Note:** *In the digital analyzer, the bandwidth of the filters depends on the selected sampling rate. If the sampling rate is reduced, the upper frequency limit may be set as low as the Nyquist limit.*

### 2.7.1 Weighting Filters

The user-definable filters in the UPL (see 2.7.2 Creating the User-definable Filters) are complemented by 13 pre-defined weighting filters, which are automatically matched to the current sample rate. Due to the digital realization, the frequency response absolutely complies with the standard. With a very small sample rate (e.g. 32 kHz in the DIGITAL instrument), some sections of the filter functions are close to the measurement range limit, resulting in distortions in these sections (with e.g. a sample rate of 32 kHz, distortions may occur in the range over 13.5 kHz). Yet, the filter is still within the permissible tolerances. For this reason, it is not possible to set weighting filters in combination with sample rates smaller than 30 kHz.

**Note:** *The weighting filters cannot be set in the filter panel, but are automatically available with the filter command of the respective measuring function.*

Filter: A Weighting  
 Standard(s): DIN 45412  
 Application: Weighting for interference voltage measurements

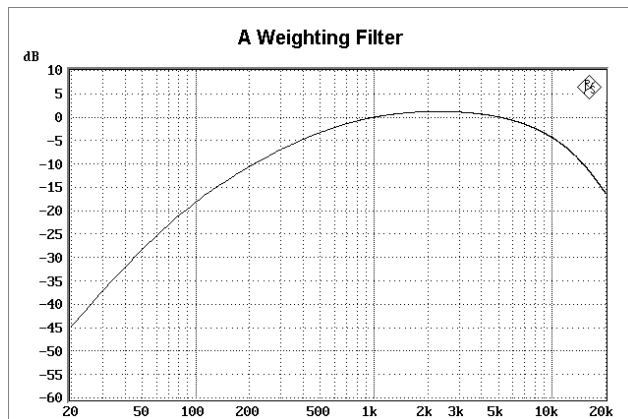

Filter: C Message  
 Standard(s): IEEE 743-84  
 Application: Transmission measurements

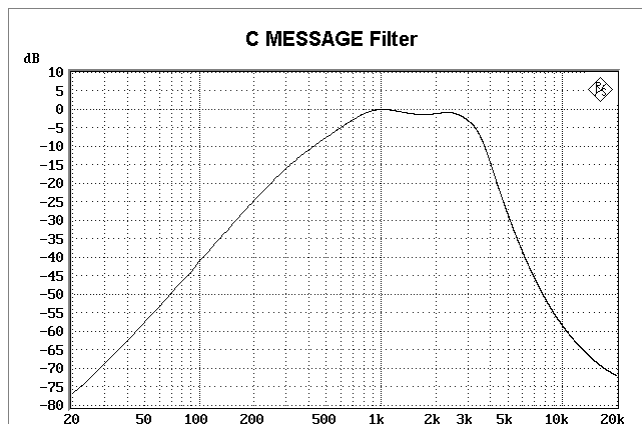

Filter: CCITT  
 Standard(s): CCITT 0.41  
 IEEE Rec. 743-84  
 CISPR 6-76  
 CCITT Rec. P.53  
 Application: Psophometric measurements

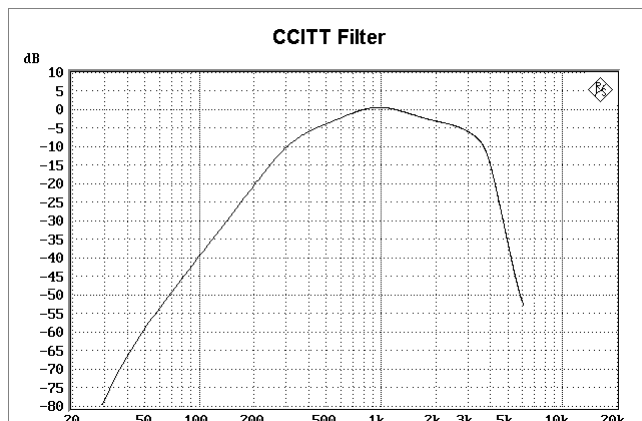



Filter: CCIR wtd  
 Normen: CCIR Rec. 468-4  
 DIN 45405  
 CCITT Rec. N21  
 CISPR 6-76  
 Application: Weighting for interference voltage measurements

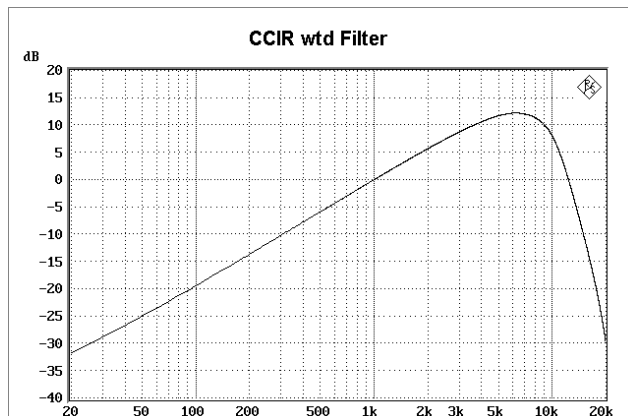

Filter: CCIR unwtd  
 Standard(s): CCIR Rec. 468-4  
 Application: Bandpass from 20 Hz to 20 kHz for band-limited, unweighted measurement to CCIR.  
 Note: Not available in analyzer 110 kHz

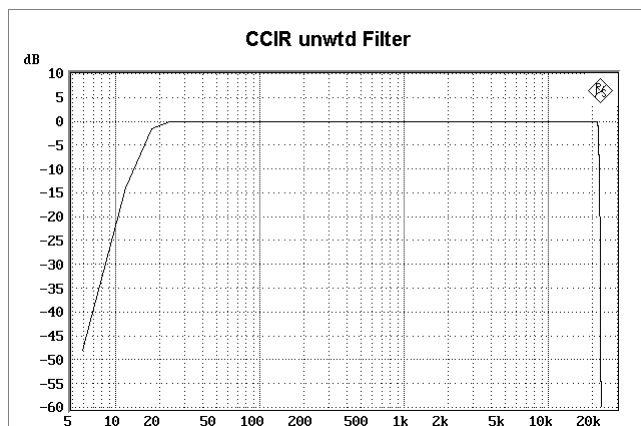

Filter: DEEM 50/15  
 Standard(s): CCIR Rec. 651  
 Application: Compact discs

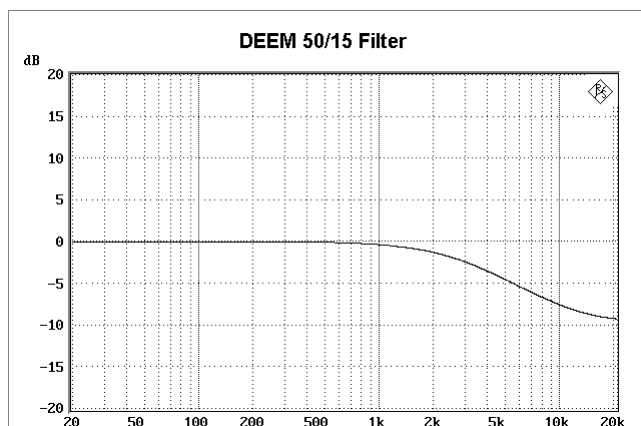

Filter: Deemph 50  
 Standard(s): ARD Pfl.Heft 5/3.1  
 Application: Unweighted and weighted S/N measurements to DIN 45405

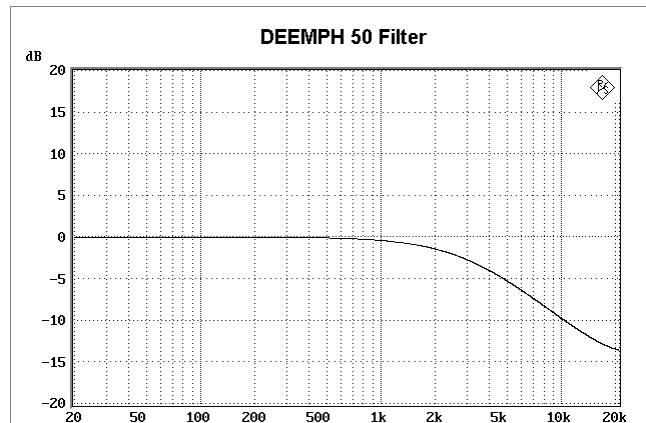

Filter: Deemph 75  
 Standard(s): same as Deemph 50  
 Application: Unweighted and weighted S/N measurements to DIN 45405

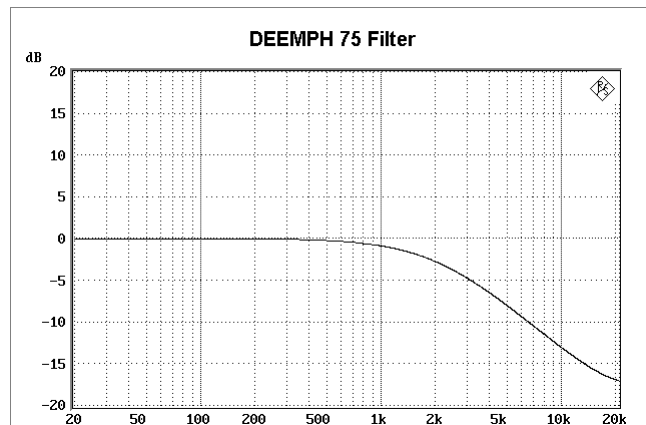

Filter: Deemph J.17  
 Standard(s): CCITT J.17  
 Application: Unweighted and weighted S/N measurements to DIN 45405

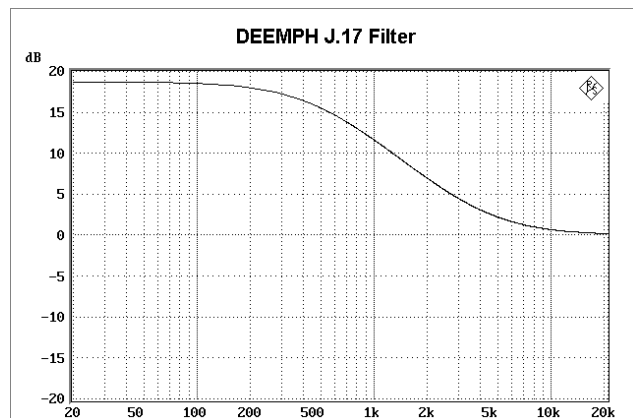

Filter: RUMBLE wtd  
 Standard(s): DIN 45539  
 Application: Testing of record players  
 Weighted S/N  
 measurements

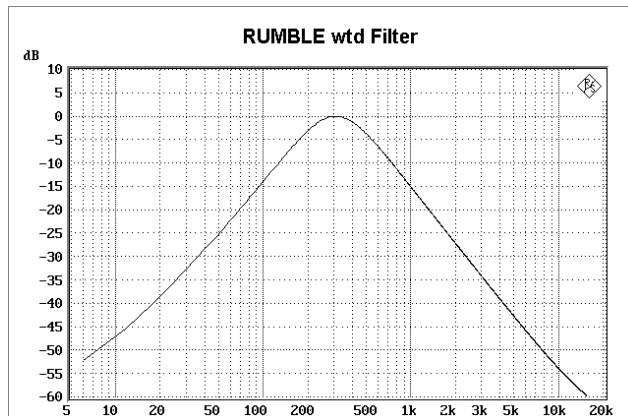

Filter: RUMBLE unwtd  
 Standard(s): DIN 368.3  
 DIN 45539  
 Application: Testing of record players  
 Unweighted S/N  
 measurements

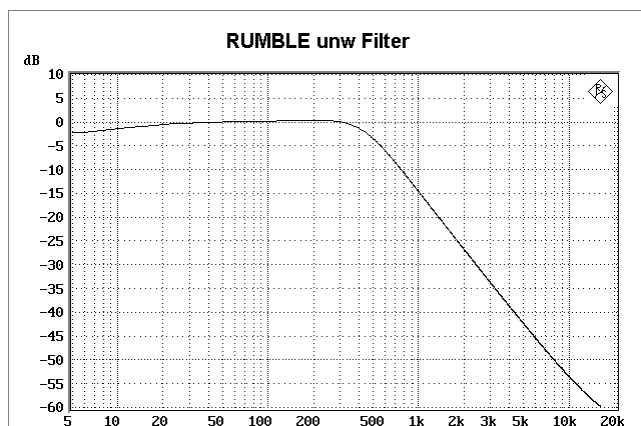

Filter: DC noise HP  
 Standard(s): ARD Pfl. Heft 3/4  
 ARD Pfl. Heft 12/2  
 Application: Highpass for DC noise  
 measurements (tape  
 machines)

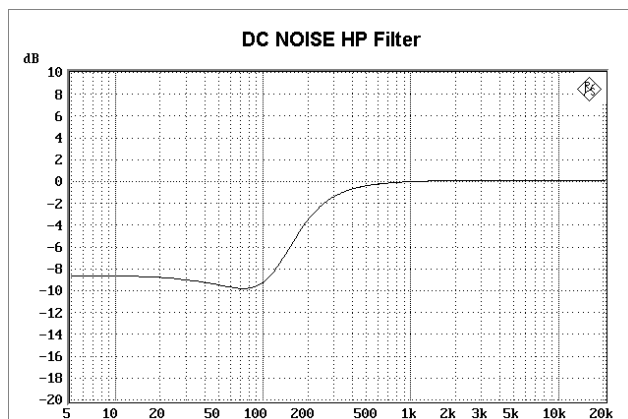

Filter: CCIR ARM  
 Standard(s): CCIR  
 DOLBY  
 NAB Standard

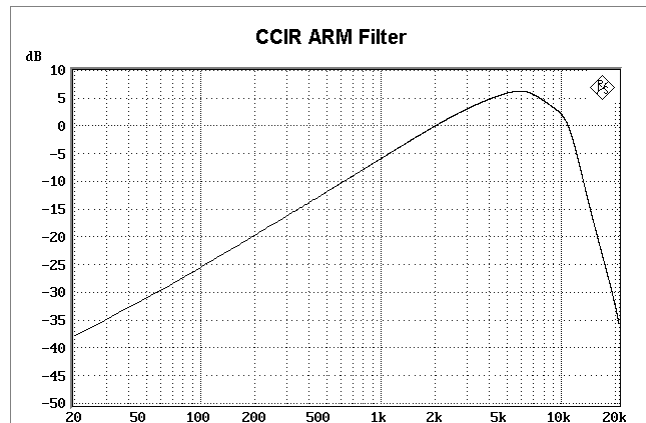

Filter: IEC Tuner  
 Standard: DIN/IEC 315  
 Application: Measurement on tuners

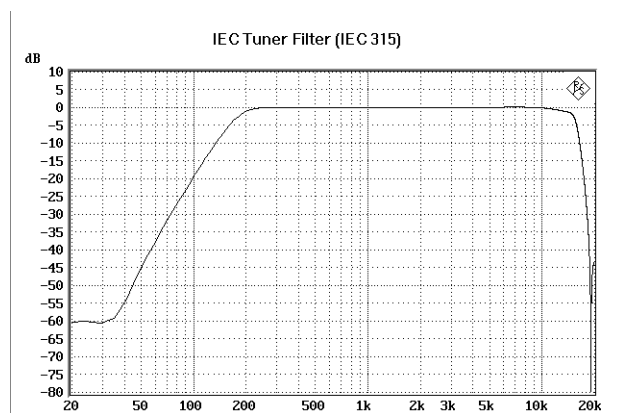

Filter: JITTER wtd  
 Norm: AES 3  
 Application: Weighting of jitter transfer function  
 1st order highpass filter  
 -3 dB at 700 Hz  
 -20 dB at 70 Hz

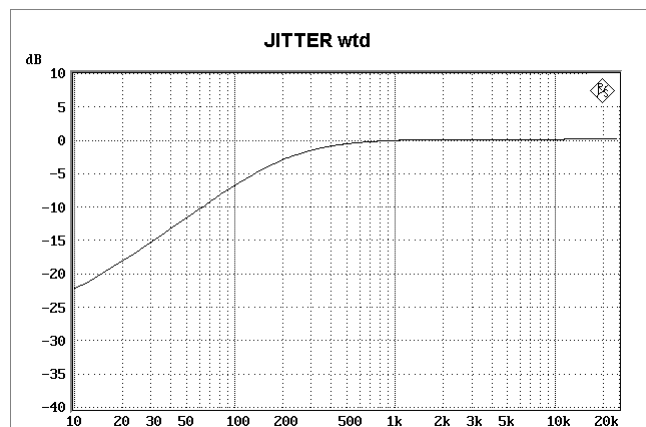

The filter shown corresponds to the predecessor (prior to UPL 3.0) and can be activated with the call parameter '-o15'.

## 2.7.2 Creating the User-definable Filters

The FILTER panel is made up of 9 filter positions designated as FILTER 01 ... FILTER 09. Each filter position can be assigned a filter of type LOW-PASS, HIGH-PASS, BAND-PASS, BAND-STOP, NOTCH, 1/3 OCT FLT, OCTAVE FLT, FILE-DEF, which are referred to below. Each filter type is predefined by its cutoff frequencies and the desired filter attenuation. After the filter has been calculated, further filter data (settling time, actual attenuation, stopband range, which are displayed in a different color) are available in the FILTER panel.

There is also the possibility of reading in any desired filter by selecting "FILE DEF".

Any filter defined in the FILTER panel is provided with a short name, which is then used to call the filter in the ANALYZER panel. The short name refers to type and cutoff frequency of the filter.

The filters have been implemented as recursive filters (=IIR filters) with 8 poles.

The filters are defined in terms of their frequency limits, which is why the contents of the FILTER panel is independent of the selected ANALYZER instrument ANLG 22 kHz, ANLG 110kHz or DIGITAL. Filter parameters which used to make sense for a certain instrument may be futile in combination with another instrument.

### Example:

A lowpass with a cutoff frequency of 50 kHz is a commonly used filter with the ANALYZER instrument ANLG 110kHz, however ineffective in the instrument DIGITAL or ANLG 110kHz.

For this reason, proceed in the following order when setting the filters:

1. Switch all filters in the ANALYZER panel off:  
Enter any desired filter parameters in the FILTER panel. The filter parameters are neither checked nor updated.
2. In the ANALYZER panel, select a filter from the FILTER panel: now, the parameters of the filters are checked:
  - a) Valid filter parameters: filter is set
  - b) Invalid filter parameters: error message on the screen, filter remains OFF
3. Try to modify in the FILTER panel filter parameters of a filter selected in the ANALYZER panel:  
A dialog window appears where you can enter the new filter parameters. When you press the O.K. key in the dialog window the filter parameters are checked.
  - a) Valid filter parameters: filter is set
  - b) Invalid filter parameters: error message on the screen, the dialog window remains open for further entry of filter parameters.

Exiting the filter dialog window using CANCEL or ESC causes

- the filter in the ANALYZER panel to be switched OFF.
- the most recently valid filter parameters to remain unchanged in the FILTER panel.

**Note:** *A certain type of filter can be repeatedly assigned with the same or different filter parameters to the 9 filter positions!  
The sum frequency response of the set filters can be displayed with the help of the simulation (see FILTSIM function).  
You can select the filters in the ANALYZER panel in any desired order. For reasons of stability, it is however useful to select the filter with the "hardest" characteristics (e.g. very narrow bandstop filters) as the last one (below in the panel).  
It is possible to superpose several filters of the same type and with equal filter parameters for one measurement function. To give an example, a very steep 80-dB lowpass (in this case, with 16 poles, yet double ripple in the passband range) can be realized by superposing two 40-dB lowpasses.*

### 2.7.2.1 Common Parameters of All Filters

**Atten**

(=Attenuation). Specify the desired filter attenuation in dB (example: 40 dB). After the filter has been checked and set, the actually realized attenuation (usually higher) is entered. Filter attenuations can be implemented about every 10 dB.

**Exception:** *The filter calculation file (see 2.7.2.6 Internal Calculation of Filters) has been modified.*

**Delay**

(Read only)

Enter the estimated settling time of the filter in seconds. This value is updated only when the filter is checked.

**Exception:** *File-defined filters. Subsequent to entry of the coefficients, the software calculates a delay and enters it in the menu line where it can be modified manually.*

**Shortname**

(Read only)

Specify a short name used later to call the filter in the ANALYZER panel. The short name is made up of an abbreviation (2 letters) for the filter type and the frequency (LP = lowpass, HP = highpass, BP = bandpass, BS = bandstop, TZ = third-octave filter, OC = octave filter, NO = notch filter).

2.7.2.2 Lowpass / Highpass

**Filter**

Select a lowpass or highpass.

LOW PASS  
HIGH PASS

**Order**

Specifies the filter order

4  
8

By reducing the filter order from 8 (standard) to 4, faster but less steep filters can be created. The order can be determined separately for each highpass or lowpass filter.

**Passband**

Specify the cutoff frequency of the passband range.

**Stopband**

(Read only). Display of the cutoff frequency of the stopband range, which is determined by the selected attenuation and passband range. This value is updated only when the filter is checked.

The basic filters used have eight poles, 'elliptic c'-type to /SAAL 88/ with a ripple of 0.1 dB in the passband range.

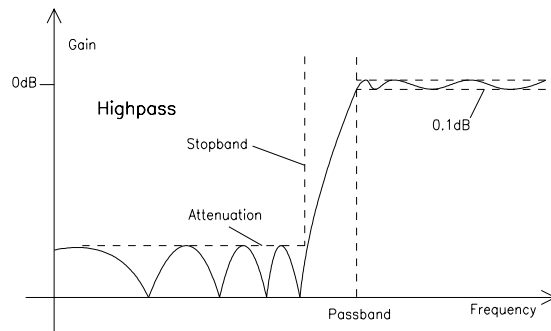
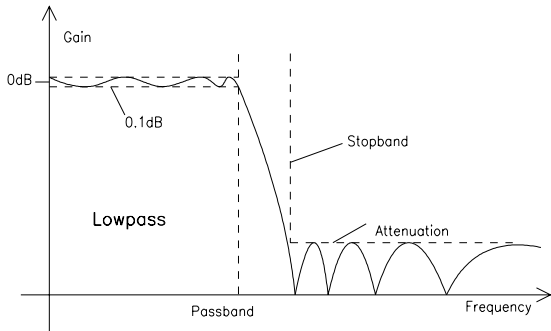

Fig. 2-33 LOWPASS and HIGHPASS frequency response together with filter parameters

### 2.7.2.3 Bandpass / Bandstop

**Filter**

**BAND PASS**  
**BAND STOP**

**Passb Low**

Enter the lower cutoff frequency of the passband range.

**Passb Upp**

Enter the upper cutoff frequency of the passband range.

**Stopb Low**

(Read only)  
Display of the lower cutoff frequency of the stopband range, which is determined by the selection of attenuation and passband range. This value is updated only when the filter is checked.

**Stopb Upp**

(Read only)  
Display of the upper cutoff frequency of the stopband range, which is determined by the selection of attenuation and passband range. This value is updated only when the filter is checked.

The basic filters used have 4 poles, 'elliptic C'-type to /SAAL 88/ where one basic filter is used for the upper and one for the lower filter edge. As 'elliptic C' has a pole at infinity, a bandstop of this type features a pole in the center between the two passband frequencies.

Values for Passbd low and Passbd upp which are close to each other cause long settling times during realization and the danger of limit cycles (oscillations of the filter on account of self-excitation induced by rounding noise). In this case, it is useful to simulate the filters before the measurement (see analyzer function FILTSIM).

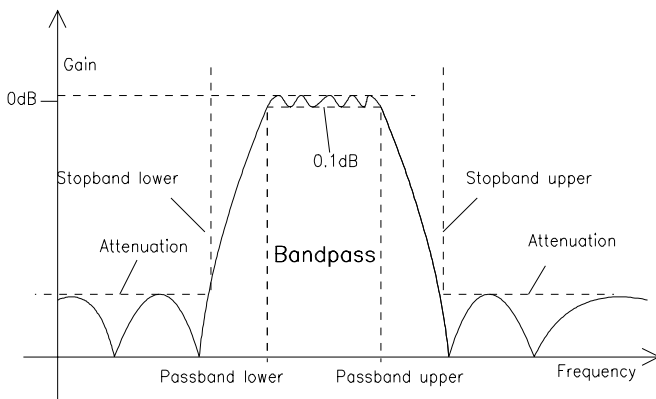

Fig. 2-34 BANDPASS frequency response together with filter parameters



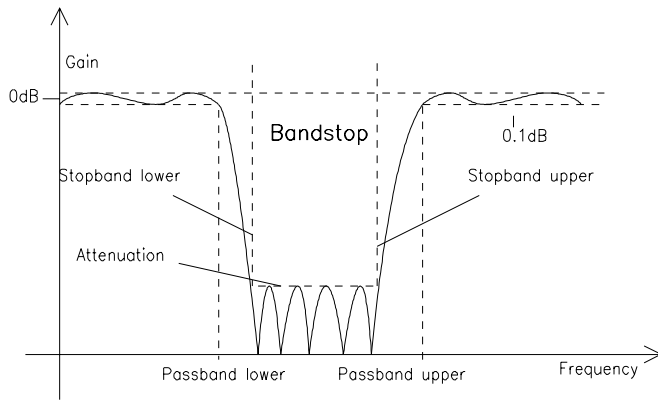

Fig. 2-35 BANDSTOP frequency response together with filter parameters

2.7.2.4 Notch

Filter

NOTCH FLT

Center Freq

Enter the center frequency of the bandstop.

Width

Enter the difference between upper and lower cutoff frequency of the passband range.

Stopb Low

(Read only)  
Display of the lower cutoff frequency of the stopband range, which is determined by the selection of attenuation and passband range. This value is updated only when the filter is checked.

Stopb Up

(Read only)  
Display of the upper cutoff frequency of the stopband range, which is determined by the selection of attenuation and passband range. This value is updated only when the filter is checked.

The basic filters used have 4 poles, 'elliptic C'-type to /SAAL 88/ where one basic filter is used for the upper and one for the lower filter edge. As 'elliptic C' has a pole at infinity, a bandstop of this type features an attenuation pole at the center frequency.

Use:

Attenuation of single frequencies in the signal.

Small values for "width" cause long settling times during realization and the danger of limit cycles (oscillations of the filter on account of self-excitation induced by rounding noise). In this case, it is useful to simulate the filters before the measurement (see analyzer function FILTSIM).

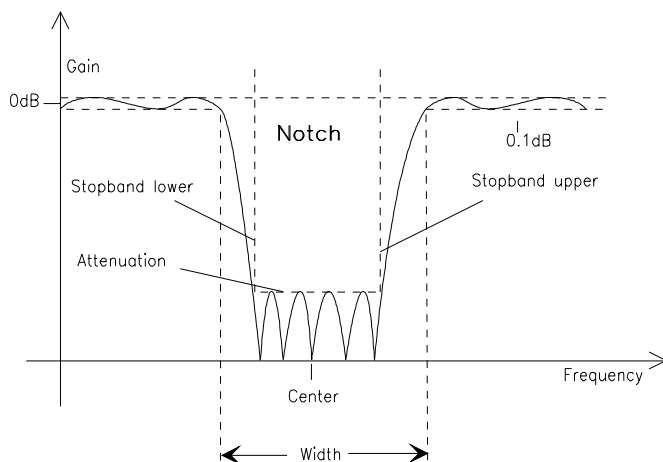

Fig. 2-36 Notch filter frequency response together with filter parameters

2.7.2.5 Third-octave / Octave

**FILTER**

**1/3 OCT FLT**  
**OCTAVE FLT**

(1/3 OCT FLT = third-octave filter)

**Center Freq**

Enter the center frequency of the bandstop.

**Width**

(Read only)

Enter the difference between upper and lower cutoff frequency of the passband range.

These filters have been implemented as bandpasses (see 2.7.2.3 Bandpass / Bandstop) which are geometrically symmetrical to the center frequency, thus allowing the passband cutoff frequencies to be calculated from the center frequency:

$$\begin{aligned} \text{1/3 octave filter: Passbd low} &= \text{Center Freq} / 1.12246 \\ \text{Passbd upp} &= \text{Center Freq} \times 1.12246 \end{aligned}$$

$$\begin{aligned} \text{Octave filter: Passbd low} &= \text{Center Freq} / 1.41421 \\ \text{Passbd upp} &= \text{Center Freq} \times 1.41421 \end{aligned}$$

**Note:** For these filters the 0,1dB-bandwidth is reduced in order to obtain an attenuation of 3 dB at the cut-off frequencies. Hence the effective bandwidth is lower than the theoretical values of third octave and octave filters.

$$\text{theoretical bandwidth third octave: } \sqrt[3]{2} - \frac{1}{\sqrt[3]{2}} = 0.2315 = 23.15\%$$

$$\text{theoretical bandwidth octave: } \sqrt[2]{2} - \frac{1}{\sqrt[2]{2}} = \frac{1}{\sqrt{2}} = 0.7071 = 70,71\%$$

### 2.7.2.6 Internal Calculation of Filters

All filter parameters are transformed from the Z range (digital, sampled) to the s range (analog, continuous) using the sample rate valid for the respective instrument. In the s range, the filter parameters are normalized to a passband limit of 1.0. The filter suitable for this transformed filter with respect to the type (i.e., elliptic c and eight-pole for highpasses and lowpasses and four-pole for bandpasses) and minimum desired attenuation is searched for in the filter data base. This filter is then denormalized and retransformed while the actual stopband and actual attenuation are being calculated. This transformation is performed with the currently effective sample rate. The predefined cutoff frequencies are maintained, however different stopband frequencies will be obtained (depending on the selected sample rate). When the sample rate on which the calculation is based does not match the actual clock rate (e.g. in the case of a wrong entry), both passband frequency and stopband frequency are shifted.

After the start of the measurement (e.g. through a new setting, pressing of the START key or in the case of SWEEP), UPL waits for a certain settling time per filter before the actual signal integration. This settling time is calculated on the basis of the desired attenuation and the filter coefficients. If (in exceptional cases) the time calculated is too small, the filters have not completely settled at the start of the measurement.

To remedy this, the following trick is possible:

If the FILE\_DEF filter "DELAY.COE" is selected, a settling time can be entered there which is considered in addition to the normal settling time in the measurement. Filter DELAY.COE has no function otherwise.

The filter data base is filled with the filters in the 'ref-lp.rlp' file in the C:\UPL\REF directory on start of the system software.

The filters contained in this file are derived from /SAAL 88/. Their ripple in the passband range is 0.1 dB.

**Note:** For the ANLG 110 kHz analyzer a reference lowpass filter of 74 dB and with 0.03 dB ripple is used for the RMS selective measurement.

### 2.7.2.7 File-defined Filter ("FILE-DEF")

For applications requiring additional filters which are not offered by the instrument, any desired filter can be read in from a file. The filter in the file must be an IIR filter with 8 poles/zeros. The filter must be designed (in the Z range, i.e. digital, sampled) with reference to the sample rate used in the respective ANALYZER instrument. Two data formats are supported:

- a) **Coefficient output file of FDAS**, version 2.1 and 2.2. FDAS is a filter design program from the company of Momentum Data Systems. Select a cascade of biquads with 32-bit float number representation as implementation for generation of the filter with the help of FDAS.

**Example:** see R&S-EXAM.COE file in the C:\UPL\USER directory

- b) **ASCII file** where the poles and zeros (in the z level) must be entered as floating numbers. 8 poles and zero positions (4 pairs) only are permissible. Unused poles and zeros must be shifted to the origin of the z level.

**File format:**

- 1st line: Identification: 'pole zero file'
- 2nd line: Key word 'gain' followed by a float number: specification of filter gain
- following lines: Key word 'pole' or 'zero' followed by real and imaginary part. Complex conjugate pairs must be consecutive and be at the 1st, 3rd, 5th or 7th position, respectively.

The transfer function is given by:

$$S(z) = gain * \frac{\prod_{i=0}^3 (z - z_{oi}) * (z - z_{oi}^*)}{\prod_{i=0}^3 (z - z_{pi}) * (z - z_{pi}^*)}$$

where S(z) is the normalized transfer function, z<sub>o</sub> are zeros and z<sub>p</sub> are poles.

The filter should be checked using the simulation.

Comment lines should begin with '#' and are permissible anywhere; no difference is made between upper-case and lower-case letters.

**Example:** see R&S\_EXAM.ZPZ file in the C:\UPL\USER directory

The coefficient file (\*.COE) is valid only for the sampling rate defined when the filter was designed. Pole/zero files (\*.NPZ) can be converted to the current sampling rate, their frequency response being maintained.

Both types are offered in the file box for the file-defined filters.

Literature:

/SAAL88/: Rudolf Saal, Handbook of Filter Design, 2nd edition, Hüthig 1988

## 2.8 STATUS Panel

### Activating the STATUS panel:

UPL front panel: STATUS  
 External keyboard: ALT + S

The STATUS panel can be activated only in part-screen graphics mode (see 2.10.9 Switching between Full-screen and Part-screen Mode) and is always on the left side of the screen.

The STATUS panel displays only those command lines of a panel which have been ticked (select the position before the line using the tab ← keys, press SELECT, the tick is switched on and off (toggle function). The UPL thus offers the possibility of displaying a clearly structured excerpt from all settings on the left side of the screen.

Instead of using the other panels, the UPL can also be operated from the STATUS panel, allowing you to carry out constantly recurring operator sequences from one panel only. Use of the STATUS panel is especially advantageous for display and, if required, printout (see 2.14) of graphics on the right side together with the essential UPL settings on the left side of the screen.

Empty STATUS panel.  
 No command lines have been ticked off.

Command lines in the GENERATOR, ANALYZER and DISPLAY panel have been ticked off.

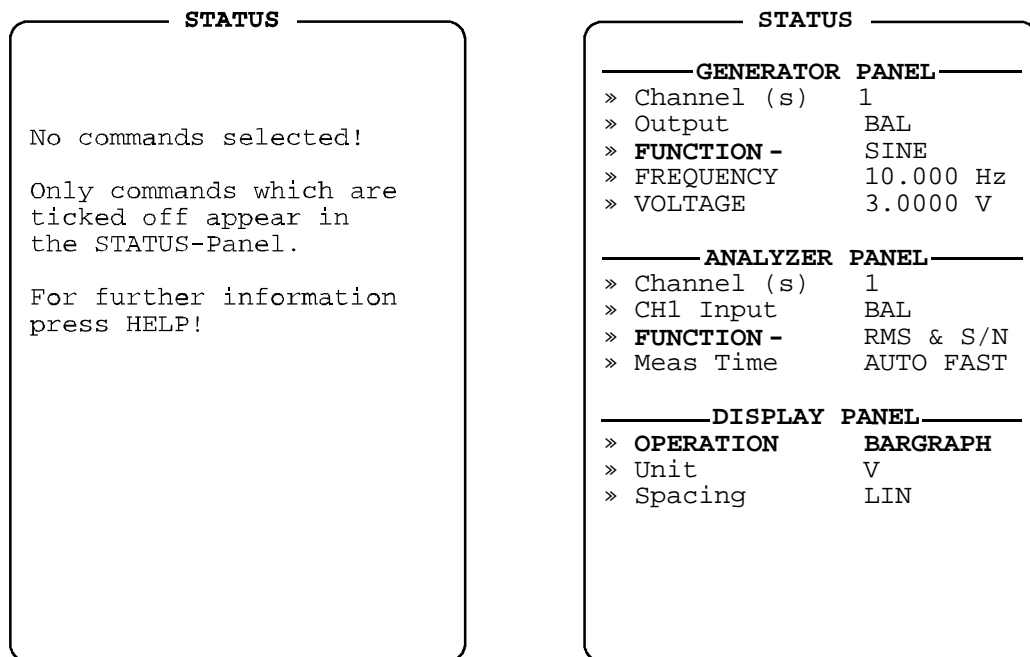

Fig. 2-37 Status panel

## 2.9 Series of Measured Values, Files and Loadable Instrument Settings (FILE Panel)

The FILE panel is activated by pressing the FILE key (UPL front panel) or the key combination "ALT F" (external keyboard). The FILE panel is always displayed on the left side of the screen.

### 2.9.1 Loading and Storing

Files can be stored to hard disk (drive "C:") or floppy disk (drive "A:"). All system files are available on hard disk and, in the default setting, the user files too. The user files can also be written to or read from diskette.

UPL system software updates are also loaded from diskette (see 1.2.1 Enabling Software Options). For storing files on diskette, DOS- formatted 3.5" diskettes are required. Unformatted diskettes can be formatted on operating system level using the command

```
FORMAT A:
```

An external keyboard is required for this purpose.

Insert the diskettes into the drive with the metal slider pointing to the front and the label to the left. The diskette is ejected by pressing the eject key.

On the left side of the diskette, there is a lockable write protection; the disk is write-protected when the hole is free.

The individual types of files are characterized by reserved file types (file extensions), which are listed in the table below. It also provides information on where, i.e. in which panel, the file is loaded.

Table 2-35 Meaning of file extensions

Extension	Meaning
.AES	Report information AES/EBU+S/P DIF
.BAT	Batch file for automatic execution of several programs; reserved (DOS)
.BPZ	Binary file with poles-zeros
.CAL	Calibration file; reserved for calibration factors
.COE	Coefficient file for filters (see 2.7.2.7)
.COM	Executable programs; (e.g. BIOSW.COM); reserved (DOS)
.DWL	Dwell time for automatic generator sweeps: loaded in the GENERATOR panel, menu item "Dwell List"
.ERR	Error file for limit violations loaded in the DISPLAY panel by selecting Trace A/B →FILE; OPERATION → LIM REPORT;
.LOG	Prolog and epilog for HPGL (see 2.14 Printing / Plotting / Storing the Screen Contents (OPTIONS Panel))
.PLT	Colour palette information for PCX and printer (see 2.14 Printing / Plotting / Storing the Screen Contents (OPTIONS Panel))

Extension	Meaning
.EXE	Executable programs; (e.g. UPL_UI.EXE); reserved (DOS)
.FTF	Amplitude/frequency table for generation of noise in the frequency domain (see 2.5.4.11)
.GL	Screen hard copy (Destin HPGL file) is generated in the UPL for subsequent output to a HPGL printer
.HLP	Help file
.LLW	Limit curve (LOWER) loaded in the DISPLAY panel under the heading LIMIT CHECK, "Lim, Lower" menu item "File name"
.LUP	Limit curve (UPPER) loaded in the DISPLAY panel under the heading LIMIT CHECK, "Lim, Upper" menu item "File name"
.NPZ	reserved for filters
.NRM	Normalization file reserved for filters
.OUT	DSP files reserved for programs to be down-loaded to the DSPs
.PAC	Protocol analysis (AES/EBU, SP DIF), screen control file for channel status data
.PAU	Protocol analysis (AES/EBU, SP DIF), screen control file for channel status data
.PCX	Screen Hard Copy (Destin PCX file) generated in the UPL to be copied to other programs
.PGC	Protocol generation (AES/EBU, SP DIF), user data, file for channel status data
.PGU	Protocol generation (AES/EBU, SP DIF), user data, file for channel status data
.PPC	Protocol generation (AES/EBU, SP DIF), user data, file for user-definable PROTOCOL panel
.RLP	Reference lowpass (reserved for filters, see 2.7.2.7)
.SAC	Partial setup; loaded in the file panel under the heading LOAD INSTRUMENT, menu item Mode→ACT SETUP
.SCO	Setup; loaded in the FILE panel under the heading LOAD INSTRUMENT, menu item Mode→COMPL SETUP
.SPV	Sweep list for generator voltage loaded in the GENERATOR panel, menu item "VOLTAGE" or "TOTAL VOLT" (depending on the function) for X- or Z-axis sweep
.SPF	Sweep list for frequency of the generator or selective rms measurement; loaded in the GENERATOR panel, menu item "FREQUENCY", "MEAN FREQ" or in the ANALYZER panel, menu item "File name" for X- or Z-axis sweep
.SPO	Sweep list for burst duration loaded in the GENERATOR panel, menu item "ON-TIME" for X- or Z-axis sweep
.SPI	Sweep list for burst interval loaded in the GENERATOR panel, menu item "INTERVAL" for X- or Z-axis sweep
.TRC	Trace lists for recording of measured values loaded in the DISPLAY panel by selecting Trace A/B → FILE
.TTF	Time table for generation of arbitrary signals (see 2.5.4.10)
.VEQ	Equalizer file loaded in the GENERATOR panel, menu item "Equal File" or as RANDOM Freq-File
.ZPZ	Pole-zero file reserved for filters
.CFG	File with control instructions for working directories

**Note:** Reserved files must not be changed or renamed.



### 2.9.1.1 Loading and Storing of Instrument Setups and Complete Setups

Setups are loaded and stored by entering a file name in menu item "Filename". If the desired file name is already in the menu line, one simply has to open and close the appertaining selection box. (see 2.3.2 Data Entry).

#### **LOAD INSTRUMENT STATE**                      Loading an instrument setup

An instrument state can be loaded either user-defined or with reference to an application. The untrained user is advised to start with the application level which provides a great number of predefined measurement setups. The default setup or user-defined setups can only be loaded via USER DEF.

The working directory of the setup is loaded together with the instrument setup, i.e., the current working directory is modified. This is usually useful in order for the file names in the setup to be referred to correctly (if they were stored without path name).

When loading a setup from the application level the *current* working directory is entered in the application setup and, thus, remains valid. It is therefore easier to *use* the application setups. (Pathless) file names are not used in the application setups.

The working directory entered in the application setup will, however, preferably *not be overwritten* for preconfiguring the application setups (once) when the setups are to be stored at their original location and the original working directory is to be retained. This can be achieved using two methods:

- Do not load the application setups from the application level but directly via USER DEF.
- Start the UPL using the **command line parameter "-tappi"**; the application setups will not be modified even when being loaded from the application level, then.



Mode	
DEFAULT	<p>(available only when Applicat USER DEF is selected) Determines what should be loaded and displayed.</p> <p>(Default setup) The Rohde &amp; Schwarz default setup (see 3.5) is to be loaded. This includes all presently inactive functions and instruments. A change of this setup is not recommended but possible by overwriting the DEFAULT SETUP file with a setup stored under the COMPL SETUP mode.</p>
COMPLETE	<p>(Complete setup)</p> <p>The complete instrument setup is to be loaded. This includes all presently inactive functions and instruments as well as the comments that can be entered for a hardcopy (see 2.14 <b>Printing / Plotting / Storing the Screen Contents (OPTIONS Panel)</b>). Under this item only <b>complete setups</b> (with any file extension, for instance *.SET) can be loaded.</p>
ACTUAL	<p>(Actual setup)</p> <p>The <i>actual</i> instrument setup (with or without measured values or traces) is to be loaded. Loading a current setup does <i>not</i> affect inactive instruments and functions. Under this item only <b>actual setups</b> and <b>actual+data setups</b> (with any file extension) can be loaded. The latter contain in addition measured values and traces and therefore require a longer total loading time especially when the traces are to be displayed.</p>
SETUP	<p>An instrument setup is to be loaded. The type of setup (actual or complete) is identified by means of the type extension. Under this item any setup with the file extensions <b>*.SAC or *.SCO</b> can be loaded; other extensions are not permissible.</p>
VIEW PCX	<p>This item allows the display of 4-bit) PCX pictures at a 1:1 scale. PCX files recorded in the UPL can thus be subsequently displayed on the UPL. The PCX picture is displayed until any key is pressed. The PCX image can be output to a connected printer by pressing the HCOPY key, if PRINTER/SPC is set under Hardcopy Destination in the OPTIONS panel.</p> <p><b>Note:</b> <i>The PCX pictures do not contain softkeys. The current (unlabelled) softkeys are therefore displayed.</i></p>

**Measuring**

(available only when Applicat USER DEF is *not* selected). Opens a dialog box where the measurements pertaining to the selected application are listed in alphabetical order. The name of the (SAC) file loaded when a measurement is selected is indicated in addition. From this information the experienced user can see the files to be modified to suit his specific requirements.

When loading a setup from the application level the *current* working directory is entered in the application setup and, thus, remains valid. It is therefore easier to use the application setups.

Refer to the notes at the beginning of this section for modification of the application setups.

**STORE INSTRUMENT STATE**

Storing an instrument setup

**Mode**

Selection of what is to be stored.

**COMPLETE**

(Complete setup)

The *complete* instrument setup is to be stored . This includes all currently inactive functions and instruments and all comments that can be entered for a hardcopy (see 2.14 Printing / Plotting / Storing the Screen Contents (OPTIONS Panel)). A file with the extension .SCO occupies about 80 Kbytes of mass storage.

**ACTUAL**

(Actual setup)

The *actual* instrument setup is to be stored. This includes all currently active instruments and functions. A file with the extension .SAC occupies about 8 Kbytes of mass storage.

**ACTUAL+DATA**

(Actual setup including data)

The current instrument setup *including measured values and curves* is to be stored. The required storage capacity depends on the size of the active traces.

The measurement or sweep should be TERMINATED prior to storage to make sure that valid measured data are available.

If only measured values (without *curves*) are to be stored, the traces in the display panel must be switched OFF.

**Note:** *If valid measured curves are available, this type of setup requires considerably more memory capacity (up to 100 Kbyte) and longer loading times than the actual setup. For this reason, this type should only be used when the curves are really needed.*

When loading a new instrument setup, the previous setting is overwritten. All lists (equalizer, limits, etc.) are filled with files the names of which are contained in the new setup. If a file cannot be loaded (e.g. the specified equalizer file has been cleared), an error message is generated and the file name is entered into the menu line as the error source.

**Note:** When loading setups, their file names may not exist (e.g. because they have been deleted or the setup has been adopted from another UPL). In such cases, the cause of error (usually "not found") is stated below the respective entry (e.g. "File name").

**Attrib**

- READ ONLY
- READ/WRITE

(Attributes); For storing only.

The stored file is write-protected.

The stored file can be deleted or overwritten.

Deleting a write-protected file requires the R attribute to be deleted using the DOS command ATTRIB at the operating system level.

Syntax: ATTRIB -R file name

The use of an external keyboard is necessary for this purpose. It is therefore recommended that the write protection be used only when a setup is not to be changed.

**Info Disp**

- OFF
- ON

(Info display), is displayed when the setup is *loaded* (LOAD INSTRUMENT STATE).

A comment with a maximum of 39 characters can be entered in each setup in the FILE panel under the menu item "Info Text" for a more detailed description of the measurement task or the like. When loading a setup, this comment can be displayed via the file selection window so that the purpose of the setup is known before it is actually loaded.

The "Info text" of a selected setup is not displayed, scrolling in the file selection window is possible at maximum speed.

**Note:** When a floppy is to be accessed (drive A:), the info display should preferably be switched off as otherwise scrolling in the file selection window would be considerably slowed down because of the long access times required for opening floppy files.

The info text for the selected setup is displayed in the user info line. Since the info text has to be read out of every setup, scrolling in the file selection window is slightly slowed down.

**Info Text**

Indicated when a setup is *stored* (STORE INSTRUMENT STATE).

Entry of a comment of maximum 39 characters for a more detailed description of the measurement to be performed, the DUT or the like. When a setup is *loaded*, this comment can be displayed via the file selection window (see "Info Disp").

**Filename**

Causes a file with the specified name to be loaded or stored.

If the file cannot be opened, an error message and "not found" is entered in the menu line.

For entering file names, see 2.3.2.5.

### 2.9.1.2 Loading and Storing of Series of Measured Values and Block/List Data

Series of data from recorded sweeps and/or FFTs, waveform data or filter simulation data can be stored in a file for several purposes:

- To load them at a later date as a record, for the purpose of comparison or subsequent processing. The series of measured values are loaded using the DISPLAY panel commands and are displayed in the form they were stored. They can however be provided with a different scaling or converted into other units.
- The files can be called from other programs and their data further processed. This is best done using the EXPORT or ASCII format. The structure of an ASCII file is shown in some examples (R&S\_EXAM.TRC in the C:\UPL\USER directory) which are provided with detailed comments. For more detailed descriptions refer to section **2.9.1.3 Format of Block/Listen Data**. The EXPORT format has neither a header nor a supplement and can therefore be directly imported into other programs. Since it has no additional information it cannot be loaded in UPL / UPD.
- Stored traces can be used in the UPL for several purposes: As reference traces for other traces if the results are displayed in relative units. For this, the stored traces are loaded by means of FILE under Reference in the DISPLAY panel. Moreover, the trace files can be used to provide equalization data for the generator.

The data are stored in files using commands in the FILE panel (also see 2.3.2.5 Entry of File Names). A series of measured values (Y or Y2) and its associated X-axis values are stored by means of Store TRACE A or TRACE B. If a variable reference value (i.e. a reference value as a function of the X-axis) and a relative unit (i.e. a unit needing a reference) are active, the reference values too are stored in the file. If a Z-axis sweep is selected in the generator, the Z-axis values too are stored. The entire scaling information as well as the function labeling are appended in coded form. If User Label is switched to on in the DISPLAY panel, user-defined function labels and units are also stored.

With command Store TRACE A + B, the data of the second series (trace B with the scaling of Y2) are stored, too, with their associated reference values. The corresponding format can be loaded as a dual trace by means of DUAL FILE in the DISPLAY panel. If Scan count >1 in the DISPLAY panel is active, which is always the case with Z-axis sweeps, the above series of measured values are stored not as one but as several scans. Scan groups too can be loaded from the DISPLAY panel as a unit (see 2.9.3.3 Scan Count >1).

The files are loaded for the functions they are needed. In the GENERATOR panel, for example, the sweep, dwell, and equalization files are loaded. Sweep and dwell files are also used in the analyzer mode for selective rms measurements. In the DISPLAY panel, traces (from sweeps or FFTs), reference traces (for sweeps) and limit-value files (limit files) are loaded.

All measured values are stored with their basic units: levels in V, frequencies in Hz, times in s, phases in degrees, related quantities in %. Notice that S/N data - such as S/N levels - have to be indicated in positive dB values, i.e. 0 dB is 100%, 20 dB means 1000%, the numerical value being 1000.

## Store traces and sweep lists

<b>Store TRACE/LIST</b>	<p>During a sweep, various buffers are created for sweep parameters, measured values, limit exceedings and waiting times, if any. This menu item serves to select which one of these buffers is to be stored.</p>
<b>TRACE A TRACE B</b>	<p>Store the TRACE A or the TRACE B buffer; (specify in the DISPLAY panel which measured values are to be collected in which trace buffer) (see 2.10.1 Parameters for Display of Traces and Spectra). In addition to the trace data, the values of the appropriate X-axis as well as the values for scaling from the display panel are stored to permit the curve to be displayed as it was scaled in storing.</p> <p>If a variable reference and a relative unit are used, the corresponding reference trace is stored too. If Scan count &gt;1 is selected in the DISPLAY panel, a group of traces, or pair of traces, determined by Scan count is stored in the file (with reference traces, if applicable).</p>
<b>TRACE A+B</b>	<p>A pair of traces (or a group of pairs of traces if Scan count is set to &gt;1) is stored in a file. The pair(s) of traces can be loaded as a unit by means of DUAL FILE under TRACE A.</p> <p><b>Note:</b> <i>When storing traces, also the X axis and in the case of a 2-dimensional sweep the Z axis are stored. For an assignment to the sweep parameter see X Axis and Z Axis in the GENERATOR panel (see 2.5.4.2 Sweeps ). The list formats (file types) can be seen from the table in section 2.9.1.</i></p>
<b>X AXIS</b>	<p>Store the list with the sweep points for the sweep parameter lying on the X-axis (for generation of lists used in the list sweep).</p> <p>For the generation of a sweep list, proceed as follows:</p> <p><b>GENERATOR panel</b></p> <ul style="list-style-type: none"> <li>➤ Activate the sweep system ("Sweep Ctrl → AUTO SWEEP")</li> <li>➤ Set the X-axis to the desired parameter (e.g. FREQ for the frequency sweep list)</li> <li>➤ Select the start and stop values as well as spacing of the desired parameter (recommended: LIN POINTS or LOG POINTS)</li> <li>➤ Enter the number of sweep points, which determine the number of entries in the sweep list generated later.</li> </ul> <p>Start the sweep by pressing the START key. When the sweep enters the SWP ... RUNNING state, the sweep list is available; the sweep can be aborted.</p> <p>Generating or modifying sweep lists is also possible using a text editor (e.g. EDIT from DOS).</p>
<b>Z AXIS</b>	<p>Store the list with the sweep points for the sweep parameter lying on the Z-axis (with two-dimensional sweep only, for generation of lists used in the list sweep).</p> <p>For generation of the Z-sweep list, it is advisable to proceed as described under generation of the above-mentioned X-list, however, set the values for the Z-axis in the GENERATOR panel.</p> <p>Generating or modifying sweep lists is also possible using a text editor (e.g. EDIT from DOS).</p>



Store	
<b>DWELL VALUE</b>	For sweeps with time synchronization only; store the buffer for the dwell time. The time data are obtained either from a file (with list sweep) or they are all equal (with Next Step DWELL). The dwell time or the file name for the active dwell list is entered in menu item "Dwell" or "Dwell List" in the GENERATOR panel (see 2.5.4.2 Sweeps).
<b>LIM UPPER LIM LOWER</b>	The upper or lower limit curve (tolerance mask) is stored to file. When a limit curve is loaded as is described in Section 2.10.7 Limit Check, a list of all interpolated X-Y pairs is output.
<b>EQUALIZATN</b>	<p>Equalization)</p> <p>Special case: store the frequency response of a device under test, e.g., as equalization file, which can then be read in for frequency-response compensation purposes</p> <ul style="list-style-type: none"> <li>• in a sweep with a generator sinewave signal under menu item "Equal. file" in the GENERATOR panel</li> <li>• or as generator RANDOM function with Domain FREQ and Equaliz FILE.</li> </ul> <p>For this purpose, the inverse frequency response normalized at any frequency can be stored (see menu item Norm Freq or Invert 1/n). The measurement data (frequency response) must be provided in one of the trace buffers, which can be selected under menu item "Volt sourc".</p> <p>For generation of an equalization file, proceed as follows: Connect the DUT to channel 1 and select this input/output in the generator and the analyzer. The generator is set to a frequency sweep using „FUNCTION → SINE“ (cf. 2.5.4.2 Sweeps). In the analyzer, the swept voltage of the DUT is determined using the function RMS &amp; S/N. Entry of TRACE A → FUNC CH1 in the DISPLAY panel fills the trace buffer A, which is then referred to as data source for the equalization file using the command Voltsource → TRACE A described below. Prior to storing the equalization file by entry of file name, the user should enter a standard frequency (e.g., 1 kHz) and Invert 1/n ON.</p> <p>Data obtained by filter simulation can also be converted into an equalization file. To this end select the function → FILTERSIM and set TRACE A → FUNC CH1 in the DISPLAY panel. In contrast to the above-mentioned file-generation, neither a sweep must be performed nor the DUT connected.</p>
<b>LIM REPORT</b>	<p>(Limit report)</p> <p>Stores the list of limit violations. With sweeps and FFT, 0, 1, 2 or 3 is entered into this error-report block. Information on how to interpret this code is given below. The limits or limit curves are indicated in the DISPLAY panel under menu items LIM UPPER and LIM LOWER (cf. 2.10.7 Limit Check).</p>

Format	Selection of file format used for storing. (The format need not be specified for loading as UPL / UPD automatically identifies the stored format).
REAL	<p>Data are stored in binary form and assigned the basic unit. (File extension: .TRC)</p> <p>Advantage: fast access when loading the data into UPL / UPD, short files.</p> <p>Disadvantage: this format cannot be read by the user.</p>
ASCII	<p>Data are stored in ASCII format and assigned the basic unit. (File extension: .TRC)</p> <p>Advantage: data can be read and processed by UPL / UPD and by any text editor or other program.</p> <p>Disadvantage: when reading data into external programs, the auxiliary information has to be removed and numeric results may have to be converted from the basic unit to the required unit.</p>
EXPORT	<p>Data are stored as plain text in tabulated form without auxiliary information. (File extension: .EXP)</p> <p>Trace data are displayed with the unit used in the graphics display (display: numeric value with unit), reference data with the basic unit (display: numeric value without unit). The columns are separated by tab stops; headers (before each new scan) always start with '#'.                      Advantage: the data can be read and processed without any problem by any text editor or other program. Data need not be converted.</p> <p>Disadvantage: EXP files cannot be read by UPL / UPD because the auxiliary information has been removed.</p>

Voltsource	For Store → EQUALIZATN only.
TRACE A TRACE B	<p>The trace buffer specified here must be the one containing the measurement data; the ANALYZER and DISPLAY panels must be appropriately configured (see "Store → EQUALIZATN").</p> <p>The voltage data are read from the trace buffer A/B.</p>

Normfreq	For Store → EQUALIZATN only.
	<p>Specify the frequency on the voltage value of which is normalized. Selecting the frequency at which the frequency response curve has its maximum means that the equalization file contains values from 0 to 1 only. If any other frequency is selected, factors higher than 1 occur.</p>

**Invert1/n**

**ON**  
**OFF**

For Store → EQUALIZATN only.

Inverting the frequency response causes, with the equalizer switched on, the device under test to get an equalized frequency response. Application: constant (independent of frequency response) outgoing power, pre-/deemphasis

The equalization curve is stored in inverted form.

The equalization file is not inverted.

**Filename**

Causes the trace or list to be stored under the specified file name.

If the file cannot be opened, an error message and "not found" is displayed in the menu line.

For entering file names, see 2.3.2.5.

### 2.9.1.3 Format of Block/List Files

#### Overview

The following text describes the format of the trace/list files, as it is used internally for storage of measured values and sweep, dwell, equalization and limit lists. This is of interest for the user only, if he wants to copy values into other programs, edit files or create new files for internal use. The subsequent description is intended to offer support in this case. You may additionally refer to the supplied example files (R&S\_EXAM.\*) in the directory \UPL\USER. These ASCII files contain comments and some of them are even available in various versions (e.g., R&S\_EXAM.TRC, R&S\_E209.TRC, R&S\_E212.TRC).

#### Numeric data formats (ASCII and REAL)

All values are stored with their basic units. Physically useful values have an exponent between E 6 (120 dB or mega) and E-12 (-240 dB or pico). (They are converted with the units set for curve representation).

In contrast, numbers are interpreted as factors to the reference value for limit files (cf. 2.10.7 Limit Check).

Notice in advance the description of the differences between the REAL format (binary according to 4-byte IEEE Standard) and the readable ASCII notation. The advantage of the first format is the compact setup and fast access, since the numbers do not have to be converted. However, the user normally prefers using the ASCII format which is easier to handle.

In the REAL format, the numbers are not separated by a separator and they are arranged in successive blocks, e.g., all X-values first, succeeded by the Y-values. With multiscan data (cf. 2.9.3.3 Group of Curves) the X-values then come again, followed by the Y-values etc.

In the ASCII format, all data of an index are arranged in a printable line, the data are separated by a space character and the line is terminated by carriage return / line feed (called CR/LF in the following). Multiscan data are also arranged successively, in this format.

Up to version 211 of the file format, the ASCII numbers like the REAL numbers were arranged in blocks and all numbers were separated by CR/LF. If the previous format is continued to be used for reasons of compatibility, it can be generated by setting a call parameter. This parameter is -o8 and must be inserted in the AUTOEXEC.BAT subsequent to the line containing the UPL(bat) call using an editor on the DOS level.

#### Setup

Explanation of the file setup can be most clearly arranged in simplified Backus-Nauer form. The meaning of each individual line is explained in detail in the following.

```
file := header_struct, trace [,info_struct]
```

```
trace := scan | multiscan | fft_scan
```

```
fft_scan := y_block, x_def [, y2_block]
```

```
multiscan := scan 0, count 1, scan 1 [, count n, scan n]....
```

```
scan := ascii_scan | real_scan
```

```
ascii_scan := ascii_sample 0, [, ascii_sample n]...
```

```
ascii_sample := x, [, y [, ref] [, y2 [, ref2] ] ], „CR/LF“
```

```
real_scan := y_block [, x_block [, ref_block] [, y2_block [, ref2_block] ] ]
```

x\_block, y\_block, ref\_block, y2\_block and ref2\_block are blocks of REAL (IEEE 4- byte float). With fft\_scan, y\_block and y2\_block may also be ASCII numbers separated by CR/LF.

x, y, ref, y2, ref2 are numbers in the ASCII notation, separated by spaces. CR/LF is appended to ascii\_sample.

The ASCII format allows for inserting comments. They begin with '#' character and are terminated by subsequent CR/LF. Maximum 80 characters are permitted.

## File

The first line explains that a trace/list file always consists of a header\_struct and a trace of numbers, followed by an info structure, if desired. In the following, an individual chapter is dedicated to each of the above-mentioned key-words.

### File header (header\_struct)

The header is always stored in the ASCII notation and contains 7 integers (16-bit integer) with the following meaning:

```
##### beginning of header
#
213 # version of fileformat this file is built with
0   # format: 0 for ASCII, first all y values then all x values
#       1 for binary (ieee float), successive blocks like format 0
#       2 for ASCII, pairs of values, first y then x values
1131 # mode: 16 bit integer consisting of
#       3 bits (LSBits) comb: 1 for y only, 2 for x+y, 3 for x+y+z,
#       DSP data: 4 for fft, 5 for waveform, 6 for filtsim
#       1 bit new: true since sw vers 2.09
#       2 bits dual: 0:for mono, 1:dual with equal scale,
#                   2:dual with 2 scales
#       2 bits multi: 0:single, 1:multi scan (2, 3 unused)
#       2 bits ref_trc_a: 0 no reference or value
#                       1: reference trace on file
#                       2, 3 unused
#       2 bits ref_trc_b: like ref_trc_a
#       4 bits (MSBits) reserved
3   # scan count (of first scan if multi scan)
5   # count of entries for scan 1
1   # x scale: 0 for lin, 1 for log
0   # y scale: 0 for lin, 1 for log
#
#----- beginning of scan 1
```

- The **first number** contains the version number of the file format. All previous formats can be read from an updated software version but not vice versa, which is why an update of the instrument software is advisable.
- The **second number** indicates the format. 0 means an earlier ASCII format, which contained the figures in successive blocks similar to the sequence used by the REAL format. No further details will be given here. - 1 means that the following numbers are given in the REAL format. 2 stands for the previously described ASCII format with y and x values arranged in pairs.
- With the **third number**, the individual bits are assigned a meaning, each:
  - Bits 0 to 2 explain the data structure. Value

1 stands for one-dimensional row (e.g. sweep-list),

2 for two dimensions (e.g. x- and y-data),

3 for three dimensions (generally multiscan data with Z axis),

4 indicates two-dimensional data with fixed x-values (given by start and delta values), generally FFT data

5 like 4, but waveform data and

6 for filter simulation data.

Bit 3 is always set to one starting with version 209 and indicates that the subsequent data are also defined in the data structure described here.

Bits 4 and 5 indicate whether the trace is a mono trace (0) or a dual trace (1).

Bits 6 and 7 indicate single scan(0), multiscan (1), or multiscan with z-sweep (2).

Bits 8 and 9 indicate whether the y-axis contains a reference value (1) (thus, a y-data consists of 2 numbers) or not. If not, these bits are set 0.

Bits 10 and 11 have a similar meaning as bits 8 and 9, however, they refer to the second y-value (y2) with dual trace.

The remaining four bits have been reserved for extensions.

- The **fourth number** indicates Scan Count, the number of scans contained in this file.
- The **fifth number** represents the maximum index + 1, i.e., the number of x (or y, ref , y2, ref2) samples of a scan.  

Note that, with multiscan, each scan may consist of a different amount of x/y-data (e.g., with external sweep) which is why the current number of the following values is indicated before each new scan.
- The **sixth number** is a 0, if the X axis is linear, 1 stands for logarithmic scaling. For an interpolation of intermediate values of limit curves that are neither horizontal nor vertical, these values are used in the x and y direction. For a correct graphics display it is important for the file entries and the actual scaling to be in agreement, as the measurement points in the display are connected by a straight line. If the data do not match, bent curve sections (elliptic segments) are obtained in the calculation which are not drawn in the display and therefore not visible.
- The **seventh number** is similar to the sixth but refers to the Y axis.

## Trace

The header, especially the third number specifies how to interpret the subsequent trace.

- One-dimensional

The group of one-dimensional traces/lists (e.g., frequency list of a sweep) is simply a sequence of numbers, which is separated in the ASCII notation by CR/LF and directly successive in the REAL format. Bits 0 to 2 of the third number in the header are assigned the value 1.

- Two-dimensional

The significant group of two-dimensional data (e.g., dwell, equalization, limit) contains pairs of numbers in the ASCII format

$x_0 y_0$  CR/LF

$x_1 y_1$  CR/LF

$x_2 y_2$  CR/LF etc.,

x being the independent and y the dependent value.

The sequence in the REAL format is  $x_0 x_1 x_2 \dots y_0 y_1 y_2 \dots$ . This pattern applies always which is why it is not indicated with each of the subsequent items.

Bits 0 to 2 of the third number of the header assume the value 2, i.e., sample and scan are defined as follows:

ascii\_sample = x, y

scan = sample<sub>0</sub> [, sample<sub>n</sub>]...

real\_scan = x\_block, y\_block

- Two-dimensional with reference value

Mono traces (one-channel measurements) may contain a reference value or not; it is therefore put in brackets in the following notation:

ascii\_sample = x, y [, ref]

This means that the numbers are arranged as follows:

$x_0 y_0$  [ ref<sub>0</sub> ] CR/LF

$x_1 y_1$  [ ref<sub>1</sub> ] CR/LF

$x_2 y_2$  [ ref<sub>2</sub> ] CR/LF etc.

A dual sample (two measured values for the same x-value) is obtained by:

ascii\_sample = x, y [, ref] , y2 [, ref2 ]

Generalized, a sample is defined as follows:

ascii\_sample = x, [, y [, ref] [, y2 [, ref2] ] ]

An ASCII scan is obtained by a number of samples:

ascii\_scan = Sample<sub>0</sub> [ Sample<sub>n</sub>]...

A REAL scan consists of a number of blocks:

real\_scan = y\_block [, x\_block [, ref\_block] [, y2\_block [, ref2\_block] ] ]

the x-block being defined as

x\_block =  $x_0, x_1, [ x_n ] \dots$

- Three-dimensional (multiscans)

Multiscans are obtained by successive series of scans:

multiscan = scan<sub>0</sub>, count<sub>1</sub>, scan<sub>1</sub> [, count<sub>n</sub>, scan<sub>n</sub>]....

Notice that the number of data of scan<sub>0</sub> has been defined in the header, whereas the subsequent ones are indicated prior to the subsequent traces.

If a multiscan has been obtained by a z-sweep, a one-dimensional field of z-values is added to the multiscan. Bits 0 to 2 of the third number of the header are set to 3.

- One-dimensional with steady X axis

The above-mentioned applies only for trace data which have been obtained by (internal or external) sweeps. FFT data, waveform data and filter-simulation data are characterized by a steady x-axis, i.e., the x-axis is defined by two values in this case. These values are the start value and difference value and named `x_def`; the structure is defined as `fft_scan` under Setup earlier in this section.

Multiscan, reference values and z-sweep are skipped, however, dual trace is possible. The different values of the bits 0 to 3 are selected for plausibility check with loading traces and do not imply different data structures.

### Info Structure (`info_struct`)

This data field contains values which appear in the DISPLAY panel and guarantee that a stored trace which is loaded corresponds exactly to its appearance prior to storage. Therefore, the scaling values, e.g., have to be included in the file. This structure is used with storage of trace A, trace B or dual trace, only.

It is reserved and should not be modified, since error could lead to undefined program states. The reason is that all error possibilities are eliminated with user entry and that this structure is considered to be consistent with use. Besides, it contains data which cannot be described here since they would go beyond the scope of this section. It is advisable, if required, to have a file created by the UPL by means of storing a trace variable/variable trace. All settings can be made in the DISPLAY panel and the structure described is completely inserted.

`info_struct := trace_no, trace_group, x_info, y_info, y2_info, strings, norm_y1, norm_y2`

`trace_no` indicates trace A (0), trace B (1) or dual trace (3).

`trace_group` indicates the type of x-axis, in order not to mix frequency and time axes.

`x_info := unit, ref_val, ref_unit, log_flag, upper_val, upper_unit, lower_val, lower_unit`  
`y_info` and `y2_info` are set up like `x_info`.

`strings := x_string, y_string` and `y2_string` are the user-defined axis labels.

`norm_y1` and `norm_y2` stand for the normalization factors.

`unit` consists of code (16 bits) and group (16 bits) and specifies the unit of the axis;

`ref_val` is the reference value used;

`ref_unit` is the unit assigned to the reference value (expressed again by means of code and group);

`log_flag` is 0 with linear scale (not zero with log);

`upper_val` is the top or right limit of the axis;

`upper_unit` indicates code and group of the assigned unit;

`lower_val` and `lower_unit` mean the values for the bottom or left limit of scale.



### 2.9.1.4 Editing Limit Files

Limit files can be edited at the MS-DOS level using any editor capable of generating text files. The sample files R&S\_EXAM.LLW (LLW = Limit LoWer) and R&S\_EXAM.LUP (LUP = Limit UPper) used for demonstrating the file structure are stored in the directory C:\UPL\USER.

Each file consists of a header followed by the actual data. Important information can be stored in addition with the aid of comment lines.

The significance of the 7 **header values** can be looked up in section 2.9.1.3 Format of Block/Listen Data/ File header.

Example:

A limit file is to be edited with the aid of which the FFT curve of a DUT can checked for limit violations. The limit value curve should have the following characteristic:

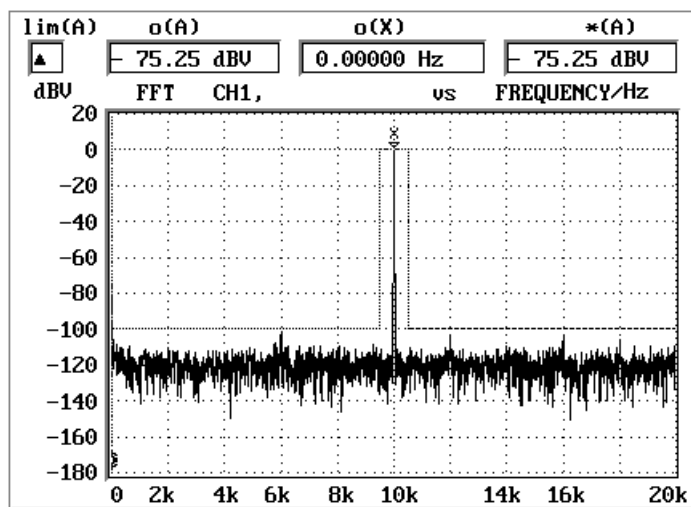

The 7 header values are determined as described in section 2.9.1.3 Format of Block/Listen Data/ File header:

1st number = **213** Number of file format for UPL version 1.0.  
 The number for UPL versions > 1.0 can be determined by storing a trace file (see 2.9.1.2 Loading and Storing of Series of Measured Values and Block/List Data) and entering `TYPE xxx.TRC | MORE` at the DOS level.

2nd number = **2** The data of this limit file are in the ASCII format, X and Y display next to each other.  
 3rd number = **10** 10 is the decimal equivalent of 1010:

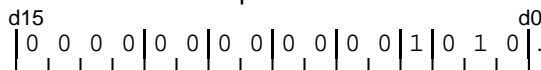

↑ two-dimensional (X and Y values)  
 ↑ always 1

4th number = **1** Number of data sets. 1 for limit files.  
 5th number = **6** Number of following X-Y pairs. Six values are required for the desired characteristic in the example.  
 6th number = **0** Linear interpretation of X axis. Irrelevant for the example using only horizontal and vertical lines.  
 7th number = **0** Linear interpretation of Y axis. Ditto

**The interpolation of intermediate values of the limit curves, which are neither horizontal nor vertical,** uses these data in the x and y direction. For a correct display of the graphic, the file entries must be in agreement with the actual scaling selected in the DISPLAY panel, as in the diagram the

measured values are always connected by straight lines. If the data do not match, bent curve sections (elliptic segments) are obtained in the calculation which are not displayed and therefore not detected.

Y values entered in the limit file must be multiplication factors which, together with the value specified in the DISPLAY panel under

```

      DISPLAY
-----
TRACE A      FUNCT CH1
Limit Ref    VALUE
              1.0000 V
    
```

form the level value used for the limit value check.

**Note:** The **use of multiplication factors** in the limit file permits limit curves to be shifted in the display as required by a change of the *Limit Ref* value. Thus the curves can be adapted to a modified generator level or another DUT.

Thus, the value 0.00001 (1 V • 0.00001 = 0.00001 V = -100 dBV) is calculated as the multiplication factor for the desired Y value -100 dBV.

X values	Desired Y values in the graphics display	Multiplication factors to be entered in the limit files
20 Hz	-100 dBV	0.00001
9500 Hz	-100 dBV	0.00001
9500 Hz	0 dBV	1.0
10500 Hz	0 dBV	1.0
10500 Hz	-100 dBV	0.00001
20000 Hz	-100 dBV	0.00001

**Content of the desired limit file:**

```

213
2
10
1
6
0
0
#----X-----Y---
20      0.00001
9500    0.00001
9500    1.0
10500   1.0
10500   0.00001
20000   0.00001
    
```

This file is stored at the MS-DOS level for instance under C:\UPL\USER\MY LIM.LUP and loaded for a display on the UPL screen as described in section 2.10.7 Limit Check.

```

      DISPLAY
-----
LIMIT CHECK -----
Lim Upper    FILE
Filename     MYLIM.LUP
    
```

**Note:** Additional information on the use of limit files is given in the Application Note **1GA33\_1E** (English) or **1GA33\_1L** (American), which can be obtained from local Rohde & Schwarz sales organizations.

### 2.9.1.5 Generating a Limit file from a Trace File

Example:

The passband range of a DUT with a C MESSAGE characteristic is to be checked with the aid of an upper and lower limit curve for compliance with a specified tolerance.

The simplest way to generate the two limit files is to create them from a trace file obtained by means of a sweep via a C MESSAGE filter. This ensures that the measured values of the limit curve correspond exactly to the x values of the sweep (provided they are not manually changed) so that the y values need not be interpolated for the detection of limit violations.

In this example the UPL-internal C MESSAGE filter is used.

#### Creating the trace file:

- Load the default setup:

```

      FILE
LOAD INSTRUMENT STATE
Mode          DEF SETUP
  
```

- Establish an internal connection to the generator, set the C MESSAGE filter for the RMS measurement and select dBV as display unit.

```

      ANALYZER
Ch1 Input...GEN CH1
Filter      C MESSAGE
Unit Ch1   dBV
  
```

- Set an auto sweep with 10 sweep points (to obtain a manageable number of limit values later on) and an output level of 0 dBV:

```

      GENERATOR
SWEEP CTRL  AUTO SWEEP
Points      10
VOLTAGE     0.0000 dBV
  
```

- Switch to curve display and select a logarithmic scale for the X axis:

```

      DISPLAY
OPERATION   CURVE PLOT
X AXIS
Spacing     LOG
  
```

Switch to graphics windows ( ↔ key or ALT Z)

- The sweep is triggered with the SINGLE key and the curve of the C MESSAGE filter is displayed.
- This curve is now stored as TRACE file under the filename CMESS.TRC:

```

      FILE
STORE TRACE/LIST ----
Format      ASCII
Filename    CMESS.TRC
  
```

The file is now available under C:\UPL\USER\CMESS.TRC with frequency values in Hz and levels in V.

- Quit the UPL (SYSTEM key or CTRL F9).

#### Creating limit files from the trace file

Files CMESS.LUP (upper limit curve) and CMESS.LLW (lower limit curve) are generated from the CMESS.TRC file at the DOS level using any editor available by modifying the level values in V derived from the TRACE file so that the desired tolerance mask is obtained.

The Y values to be entered in a limit file are **multiplication factors** which, together with the value entered in the DISPLAY panel under

```

      DISPLAY
TRACE A      FUNCT CH1
Limit Ref    VALUE
              1.0000 V
  
```

form the level value used for the limit check. The curve can be shifted by varying the Limit Ref.

Content of  
C:\UPL\USER\CMESS.TRC:

```

213
2
10
1
10
1
0
#--X-----Y-----
20000      0.000251874
9283.18    0.00154384
4308.87    0.109695
2000       0.879042
928.318    0.978155
430.887    0.317451
200        0.0551856
92.8318    0.00598586
43.0887    0.000624106
20         7.48084e-05

The data following in this list are of
no importance for the generation of
limit files and are therefore left out.
    
```

Content of  
C:\UPL\USER\CMESS.LUP:

```

213 }
2   }
10  }
1   } Unchanged from CMESS.TRC
10  } 1)
1   } 2)
0   } 3)
#--X-----Y-----
20000      0.0004
9283.18    0.01
4308.87    0.5
2000       1.2
928.318    1.1
430.887    0.5
200        0.08
92.8318    0.009
43.0887    0.0009
20         0.0004
    
```

Content of  
C:\UPL\USER\CMESS.LLW:

```

213 }
2   }
10  }
1   } Unchanged from CMESS.TRC
10  } 1)
1   } 2)
0   } 3)
#--X-----Y-----
20000      0.00001
9283.18    0.0008
4308.87    0.03
2000       0.7
928.318    0.9
430.887    0.16
200        0.03
92.8318    0.003
43.0887    0.0001
20         0.00001
    
```



↑ Multiplication factors used for determining the limit values together with the Limit Ref value in the DISPLAY panel.

- 1) Number of limit values
  - 2) Interpretation of X axis: 0 = linear, 1 = logarithmic
  - 3) Interpretation of Y axis: 0 = linear, 1 = logarithmic
- See 2.9.1.3 Format of Block/Listen Data / File header

**Loading limit files and detecting limit violations:**

After starting the UPL again, the two limit files

```

----- DISPLAY -----
LIMIT CHECK -----
Lim Upper   FILE
Filename    CMESS.LUP
Lim Lower   FILE
Filename    CMESS.LLW
    
```

are entered and the desired tolerance mask is displayed.

If a sweep is triggered now with the SINGLE key, the curve of the C MESSAGE filter is within the tolerance mask as expected, and no limit violation is signaled.

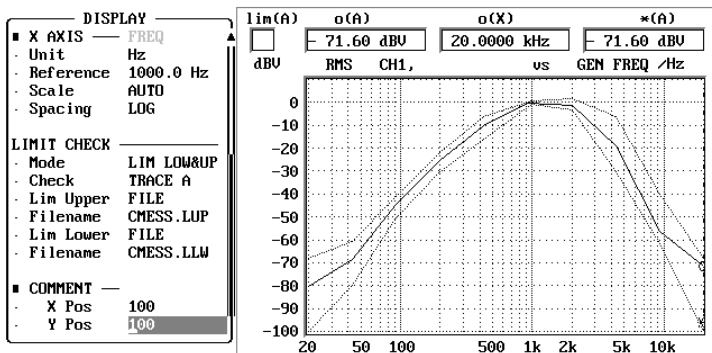

To test the limit check, a limit violation can be produced by increasing the 0-dBV sweep level in the GENERATOR panel to for instance 1 dBV or changing the Limit Ref value so that the limit curve is shifted.

In the top left-hand corner of the graphics display the icon



is displayed indicating with an arrow pointing upwards that a limit has been **exceeded**.

To find out the exact reason for the limit violation,



can be set in the DISPLAY panel. A list of all sweep parameters is displayed in which the limit violation is marked at the left by an arrow pointing upwards.

When selecting full-screen display (key  $\leftrightarrow$  followed by GRAPH or ALT Z and then ALT R) an extended list of sweep parameters is displayed with measured values of both limit curves.

**Note:** If the **x values** from the trace file are read into the limit file **unchanged**, columns 3 and 4 display the product of the multiplication factor in the limit file and of the Limit Ref value in the DISPLAY panel. If the **x values have been changed**, the **interpolated** limit values for the frequencies in column 2 are displayed in columns 3 and 4.

RMS	CH1,	vs	GEN FREQ		
o->	- 70.76 dBV		20.000 kHz	- 68.0 dBV	-100.0 dBV
	- 55.17 dBV		9.283 kHz	- 40.0 dBV	- 61.9 dBV
	-18.215 dBV		4.309 kHz	- 6.02 dBV	-30.46 dBV
	-0.1195 dBV		2.0000 kHz	1.584 dBV	-3.098 dBV
▲	0.8245 dBV		928.3 Hz	0.399 dBV	-1.570 dBV
	- 8.955 dBV		430.9 Hz	- 6.02 dBV	-15.92 dBV
	-24.175 dBV		200.00 Hz	-21.94 dBV	-30.46 dBV
	- 43.46 dBV		92.83 Hz	- 40.9 dBV	- 50.5 dBV
	- 70.91 dBV		43.09 Hz	- 60.9 dBV	- 80.0 dBV
	- 74.79 dBV		20.000 Hz	- 68.0 dBV	-100.0 dBV

↑ Measured level                      ↑ Sweep frequency                      ↑ Measured values of upper limit curve acc. to CMESS.LUP                      ↑ Measured values of lower limit curve acc. to CMESS.LLW



shows a list of limit violations. In this example there is only one entry:

RMS	CH1,	vs	GEN FREQ		
▲	0.8245 dBV		928.3 Hz	0.399 dBV	-1.570 dBV

**Note:** Further information on the use of limit files can be obtained from the Application Note **1GA33\_1E** (English) or **1GA33\_1L** (American) which can be obtained from local Rohde & Schwarz sales organizations.

### 2.9.1.6 Generating a Limit File using an Application Program

Application Note **1GA33\_1E** (*English*) or **1GA33\_1L** (*American*) and the application program **LIMIT.BAS** are available for convenient generation of limit files for use in frequency response measurements. The application program can be obtained from local Rohde & Schwarz sales organizations.

The Universal Sequence Controller UPL-B10 must be installed in order to use the program. With the aid of this option, complete measurement sequences can be run under program control on the audio analyzer.

To be able to run the application program LIMIT.BAS under the Universal Sequence Controller UPL-B10, an Audio Analyzer UPL of version 1.0 or higher is required. An external keyboard must also be connected.

### 2.9.1.7 Limit Report

The limit report list is organized like the content of a limit file (see 2.9.1.4 Editing Limit Files) and includes the information 0, 1, 2 or 3 for each frequency value.

**0:** No limit violation

**1:** A value or curve defined as `MODE = LIM UPPER` in the DISPLAY panel was **exceeded** by a sweep or FFT curve.

If more than one sweep or FFT curve is displayed, e.g.

- one curve on trace A and one on trace B with `CHECK = TRACE A+B` selected in the DISPLAY panel,

- or several sweep scans are set in the DISPLAY panel,  
then one of the curves has exceeded the upper limit.

**2:** A value or curve defined as `MODE = LIM LOWER` was **below this limit**.

If more than one sweep or FFT curve is displayed, one of the curves is below the lower limit.

**3:** If the Lim Lower and Lim Upper values or curves are simultaneously displayed in the `Mode = LIM LOW&UP` and more than one sweep curve is displayed, e.g.

- one curve on trace A and one on trace B with `CHECK = TRACE A+B` selected in the DISPLAY panel,

- or several sweep scans are set in the DISPLAY panel,

**3** indicates that one of the sweep curves is **below** the lower limit **and that at the same time** another sweep curve has **exceeded** the upper limit.

Code **3** cannot be assigned in the case of FFT curves as the limit check for `TRACE A+B` **cannot** be made simultaneously.

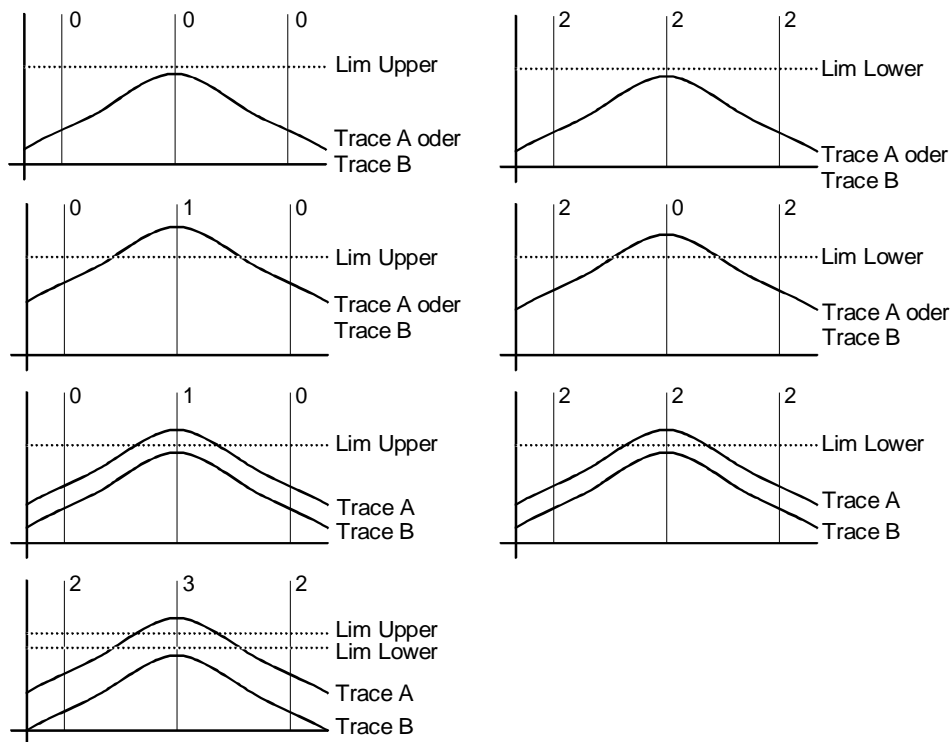

Fig. 2-38 Examples of limit violations and codes

**When**

Format = ASCII has been selected in the FILE panel under

```

FILE
STORE TRACE/LIST
Store      LIM REPORT
Format     ASCII      or REAL,
    
```

codes 0, 1, 2 or 3 are stored as ASCII values, for

Format = REAL these values are stored in binary form (4 bytes each) to IEEE standard.

The X values for which a limit violation has been detected can be seen in a comparison of the traces files and the LIM REPORT file (SCPI does not offer a more convenient solution):

**Limit report for sweep curves:**

The sweep curve used for a limit check can be selected as follows in the DISPLAY panel:

```

DISPLAY
LIMIT CHECK -----
CHECK      TRACE A      or TRACE B or TRACE A+B
    
```

**Note:** CHECK = TRACE A+B with a view to limit violations can only be set for sweep curves (not for FFT curves) if Scale B = EQUAL A has been selected for TRACE B (the scale of trace A is also assigned to scale B).

To view limit violations on the screen, set

```

DISPLAY
OPERATION SWP LIM REP
    
```

Only limit violations will be displayed.

To determine the X values for which a limit violation has been detected, the trace file has to be generated for a comparison with the LIM REPORT file:

```

      FILE
STORE TRACE/LIST
Store      TRACE A      or TRACE B
Filename   XXX.TRC
    
```

In contrast to the screen display, where only limit violations are displayed under the setting OPERATION = SWP LIM REP, the trace file contains **all** sweep points.

Example:

Content of trace file

```

213 |
 2  |
10  |
 1  | see 2.9.1.3 File header
10  |
 0  |
 0  |
#--X-----Y-----
100      0.1138  →
166.81   0.2326  →
278.265  0.4104  →
464.159  0.6457  →
774.264  0.8959  →
1291.55 1.0891  →
2154.44 1.1521  →
3593.81 1.1058  →
5994.84 0.9271  →
10000    0.6069  →

Subsequent data are of no
relevance for a check of the
LIM REPORT file and are
therefore left out.
    
```

Content of LIM REPORT file

```

213 |
 2  |
 9  |
 1  | see 2.9.1.3 File header
10  |
 0  |
 0  |
0  |
0  |
0  |
0  |
0  | Limit report
 1  |
 1  |
 1  |
 1  |
 1  |
 0  |
    
```

**Lim report for FFT curves:**

The FFT curve used for a limit check can be selected as follows in the DISPLAY panel:

```

      DISPLAY
LIMIT CHECK -----
CHECK      TRACE A      or TRACE B
    
```

**Note:** Limit violations of FFT curves can only be checked for TRACE A or TRACE B. Selection of TRACE A+B is not possible.

To view limit violations on the screen, set

```

      DISPLAY
OPERATION SPC LIM REP
    
```

Only limit violations are displayed on the screen.

To determine the X values for which a limit violation has been detected, the trace file has to be generated for a comparison with the LIM REPORT file:



```

      FILE
STORE TRACE/LIST
Store      TRACE A      or TRACE B
Filename   XXX.TRC
    
```

**Note:** *In contrast to a sweep trace, **only** the limit violations are stored in the trace file for the FFT trace. Therefore, when a suitable upper limit value is selected, the noise floor of the FFT can be suppressed and the quantity of data reduced.*

Example:  
Content of  
trace file

```

213 |
2   |
76  |
1   | } see 2.9.1.3 File header
3   |
0   |
0   |
#--X-----Y-----
9984.38    0.5991
9996.09    0.9714
10007.8    0.8815
Subsequent data are of no
relevance for a check of the
LIM REPORT file and are
therefore left out.
    
```

Content of  
LIM REPORT file

```

213 |
2   |
9   |
1   | } see 2.9.1.3 File header
3   |
0   |
0   |
1   |
1   | } Limit report
1   |
    
```

→  
→  
→

## 2.9.2 Editing Files and Directories

The following files are available under the heading UTILS in the FILE panel, which is called by pressing the FILE key.

The UPL software is supported by the DOS operating system and uses its file manager, which is normally not of importance for the user. It however provides extended capabilities, which you can make use of, if desired. For reasons of internal management, the UPL software assigns a fixed data type (extension) to each file type depending on its function, allowing the identification of the file type. The extension consists of up to three letters after the point in the file name and is usually not available to the user in other menu items (the extension used is specified in the menu items concerning files as well as in the list given in Section 2.9.1).

**Delete**

A file can be deleted using this command. All menu commands used to store files overwrite an existing file with the same name or create a new file.

**Work dir**

(Working directory)

If a directory is specified under "Work dir" that exists in the UPL, the specified directory is selected as working directory. If such a directory does not exist in the UPL, the entry is interpreted as a file name indicating a control file in which working directories can be specified for various types of file (with file extensions .SCO, .SAC, etc). If the control file cannot be found either, the user is offered three possibilities in a dialog box.

1. "Create": the entry is interpreted as the name of a new working directory which is opened and activated.
2. "Work Dir unaffected": this entry is stored under Work Dir without the previous work directory being changed. When a setup is loaded holding an entry generated in this way under Work Dir, the current working directory remains unchanged. *This means that by entering a non-existing working directory, setups can be generated which do **not** change the current working directory when loaded.*
3. "Back to filebox": an entry error has occurred, another working directory can be selected in the filebox.

### Specifying a directory:

Files can be arranged in directories allowing classification depending on, for example, the user or the project. The working directory, which precedes all file names and path names (unless they begin with a "\" in the main directory) is thus selected. Independent of the working directory, there are also directories which are used by the UPL-internal software.

Example: Work Dir C:\UPL\DUT04

No.	Data input	Data access to
1	SWEEP.SCO	C:\UPL\DUT04\SWEEP.SCO
2	\SWEEP.SCO	C:\SWEEP.SCO
3	\UPL\DUT05\SWEEP.SCO	C:\UPL\DUT05\SWEEP.SCO

Storing files in the main directory (example 2) or in the UPL system directories (\UPL,\UPL\REF,\UPL\DRIVER, etc.) should be avoided.

**Entry of a file with control statements:**

The specified file contains control statements by which a working directory is defined for various types of file.

All file names entered into the file box without a path being specified are searched for in, and taken from, the working directory defined in the control file. The working directory shown in the file box under the specified file name can be checked against the file name displayed on the UPL.

(Control file (ASCII text):	Meaning:
#Comment 1	Any comment, marked with #
.SCO C:\EXAMPLE\SETUP	Loading and storing of setups
.SAC C:\EXAMPLE\SETUP	according to \EXAMPLE\SETUP
.TRC C:\EXAMPLE\TRACE	Loading and storing of traces
#Comment 2	
.PPC C:\UPL\USER	Protocol definitions
.PAC C:\UPL\USER	
.PAU C:\UPL\USER	
.* C:\UPL\USER	Preset directory

The control file can be created at the DOS level using any type of editor capable of generating unformatted ASCII text.

. \* Designates the working directory that is set if a type of file not included in the control file is entered (default directory).

# Marks comment lines.

Leading and filling blanks are ignored. Entries can be made in any order.

If no appropriate entry is found for a specified file type, the directory specified after ".\*" is used as working directory. If no entry exists for ".\*", the path information (e.g. C:\UPL\USER) is extracted from the file name designating the control file (e.g. C:\UPL\USER\EXTDIR:CFG) and entered as working directory. If in the control file a working directory is specified that does not exist, an error message is output.

**Note:** *Several users can use setups jointly and store the results separately by using the same path for the setups and different paths for the data to be stored.*

**Example:**

Mr. MILLER, Mr. BAKER and Mr. SMITH are sharing an UPL. Each user wants a working directory of his own with the corresponding setups using the .SCO and .SAC file types and each one establishes a path named SETUP.

Mr. MILLER mainly works with .TRC trace files and therefore needs a path named TRACE.

Mr. BAKER mainly works with .COE filter coefficient files and therefore needs a path named COEFF.

Mr. SMITH mainly works with .FFT arbitrary waveform files and therefore needs a path named ARBIT.

All files of a type other than mentioned above are to be directly written to/read from the paths C:\UPL\USER\MILLER, C:\UPL\USER\BAKER or C:\UPL\USER\SMITH.

The above requirements can be fulfilled by structuring the working directories as follows (at the DOS operating system level):

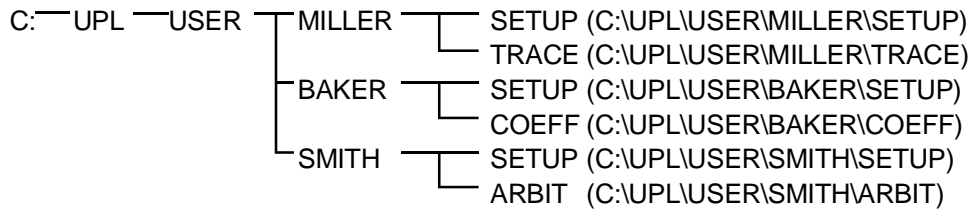

The assignment of file types to working directories is made in separate control files which are best stored under C:\UPL\USER:

## MILLER .CFG

```

# Working directories, depending on file type
.SCO C:\UPL\USER\MILLER\SETUP
.SAC C:\UPL\USER\MILLER\SETUP
.TRC C:\UPL\USER\MILLER\TRACE
# Default working directory
.* C:\UPL\USER\MILLER
  
```

## BAKER.CFG

```

# Working directories, depending on file type
.SCO C:\UPL\USER\BAKER\SETUP
.SAC C:\UPL\USER\BAKER\SETUP
.COE C:\UPL\USER\BAKER\COEFF
# Default working directory
.* C:\UPL\USER\BAKER
  
```

## SMITH.CFG

```

# Working directories, depending on file type
.SCO C:\UPL\USER\SMITH\SETUP
.SAC C:\UPL\USER\SMITH\SETUP
.TTF C:\UPL\USER\SMITH\ARBIT
# Default working directory
.* C:\UPL\USER\SMITH
  
```

After switching on the UPL, each user enters, under "Work Dir" in the FILE panel, the path and name of his control file, or loads a setup in which the path and name of his control file are already entered.

### 2.9.3 Series of Measured Values (Sweeps and Scans) and Block/List Data

With sweeps, values measured as a function of a variable input quantity are recorded and can be represented in various ways graphically or as numbers. UPL can simultaneously record two traces (Trace A and Trace B). These are in the following referred to as 1 scan.

The variable input quantity, which is usually entered along the X-axis, is determined by the sweep parameters. There are three sweep modes, of which only one can be active at a time: generator, analyzer and external/time-controlled sweep.

- In the generator sweep, the frequency or the output voltage can be automatically varied (in steps). For sine burst measurements, the ON time and the length of intervals (see 2.5.4.2 Sweeps) can be varied in addition.
- In analyzer sweeps, the "receive" frequency can be automatically stepped in (frequency-) selective rms measurements, with sweep parameter settings similar to those used in generator sweeps (see 2.6.5.3 RMS SELECT). If the multisine function (with up to 17 simultaneous frequencies) is active in the generator, a sweep list can be generated with UPL set to SWEEP CTRL GEN MLTSIN. With this list, the analyzer is automatically tuned to all generator frequencies in consecutive order.
- The third group of sweeps are external sweeps that are likewise set in the analyzer mode. With external sweeps, time-varying signals are analyzed that are not stepped by one of the UPL sweep systems but by external control. The analyzer picks up measurement values after a frequency or level change and interprets the frequency or level as X-axis parameters. Furthermore, measured values can be collected at certain intervals. In this case, time will be taken as the X-axis parameter.

In the DISPLAY panel, the set sweep parameters are always used for the X-axis. The units used depend on the physical quantity measured. The right-hand and the left-hand limit are determined by the start and the stop values of the sweep parameters and set using the X-axis autoscaling function.

#### 2.9.3.1 Scan count =1

From the six values simultaneously measured, two can be used for the two independent Y-axes (trace A and trace B). These values may be the distortion factors of the left-hand and right-hand channel, for example, but also different physical quantities such as voltage and phase. The quantities to be measured are set in the ANALYZER panel; the values to be recorded as a trace are selected in the DISPLAY panel even if a trace is not to be displayed but stored in a file.

Measured values frequently have to be referenced to other values (the measured values being expressed in relative units). If a reference value is constant (e.g. 1 mW), it can be taken into account immediately. If the reference value is a function of the X-axis, a reference trace will result. With UPL, such traces can also be formed from a series of measured values, for example, or from the generator voltage or frequency, or may be loaded from a file (e.g. as reference traces).

In all, the following is stored for one scan: two traces, two reference traces and the X-axis data since, in the case of external sweeps, the latter are also obtained through measurements values and cannot be calculated.

### 2.9.3.2 Interpolation to a Common X Axis

To allow any traces to be used as reference traces or to be displayed simultaneously for the purpose of comparison, and measured by means of the movable cursors, all traces would have to have the same X values. However, any X divisions can be used on the UPL as the values of the traces and reference traces are interpolated to the set X-axis. The interpolated values are displayed as traces or numerals. The original X and Y values are displayed only if no sweep is selected (and thus no X-axis is set). (Excepted are all limit traces; they are displayed using the original and not the interpolated values (see 2.10.7 Limit Check).

For interpolation, the X and Y values of the four traces and reference traces are stored in the UPL, yielding a total of eight series of numbers plus the four interpolated series plus the current X-axis values. This results in 13 series of 1024 values each.

UPL also interpolates further series of numbers: the limit traces for the upper and lower ranges, the equalization trace for the generator voltage, and the dwell trace for sweep stepping. Thus, only a few measured values are required for each trace. In interpolation, linear or logarithmic scaling of the X and Y axes is taken into account as, when switching from linear to logarithmic scaling, segments of an ellipse would be displayed instead of a straight line.

All traces are interpolated once at the start of a sweep to make for enhanced measurement speed. In the case of external sweeps, the X values are unknown at the start of the sweep. In this case, interpolation cannot be made prior to the sweep but must be performed during the sweep.

### 2.9.3.3 Scan Count >1

The number of sweeps performed by UPL is not limited to one X sweep but can be increased to n sweeps by means of the setting Scan count <n> (in the DISPLAY panel). A group of traces will be obtained as graphical representation. All traces are stored (in the UPL and also as a file, if desired) and can be displayed as one unit, rescaled and recalled. In the Scan GROUP mode, the 13 series of numbers mentioned above are multiplied by the number of scans.

In the generator mode, a second sweep can be made in addition to the X sweep. The second sweep is referred to as Z sweep as it is usually represented along the Z axis. When Z sweep is selected, the number n of the scans is automatically set to the number of the Z points (Scan count is set according to the number of Z points).

In the Scan count >1 mode, a series of traces (or a series of pairs of traces) is usually displayed. In autoscaling of the Y axes, all available traces are included. Any other operations, e.g. setting the cursor to the min. or max. values, only apply to the current scan. For out-of-tolerance checks (limit checks), all traces are checked against the same two limit traces, the out-of-tolerance symbol applies to the current pair of traces.

The current scan (with one or two traces) is selected with the PAGE UP/PAGE DOWN keys on the keyboard. The current value, i.e. the scan index, is indicated by a number between the out-of-tolerance field and the left-hand cursor-value field. The scan index is set by remote control with command DISPlay:TRACe:INDex <n>.

The point of intersection of the cursor with the current trace (or pair of traces) is visually emphasized by means of a circle. It is thus possible to allocate the cursor values indicated in the windows unambiguously to the current scan.

The most recently recorded scan is displayed with a number ("#n") in the upper left corner providing the space is not occupied by the out-of-tolerance field.

If one of the list modes (SWEEP LIST, SPECTR LIST, SWEEP LIMIt REPort or SPeCtrum LIMIt REPort) is selected, the corresponding lists are generated anew after a change of the scan index (with the PAGE UP/ PAGE DOWN keys), since only one scan (pair of traces with X axis) can be displayed at a time.

With FFT, a large amount of numbers (up to 7424) is obtained, although no more than one scan is available. For this reason, the scan index is used for organizing the number in 1-k blocks and selecting them accordingly. This is not only useful for the screen display but also for reading the block data via remote control or the universal scan control with BASIC (UPL-K1). With remote-control command DISPlay:TRACe:INDex, a 1-k block is selected to which the subsequent inputs and outputs with FFTs refer. With sweeps, the command serves for selecting a desired scan from a group (or to select the Z index). The index runs from 0 to Scan count -1.

Another way of reducing the numbers transferred with FFTs is by using the out-of-tolerance function. Only values above the limit value defined by UPPER LIMIT are accepted as measurement values and can be read with LIST1 and TRAC1 or TRAC2 if OPERATION SPC LIM REP is set in the DISPLAY panel. In this case, the error report block which is read in with "CALC:LIM:REP?" is meaningless, since all values would have to be marked as being out-of-tolerance (i.e. by 1) (see 3.10.10 Commands for Input/Output of Block Data).

In the case of sweeps, "0" is entered in the trace index in the error report block if no sweep values are out of tolerance. If the limit in channel 1 is exceeded, 1 is entered, with channel 2, 2 is entered; if limit violations occur in both channels, 3 is entered. The X and Y values belonging to this index will be found under the same index in the LIST1 and TRAC1 or TRAC2 blocks.

If no group of traces is selected (Scan count =1), the measurement currently being taken is indicated by means of a gap moving along the trace. If several traces are displayed on the screen (Scan count >1), the gap may no longer be visible; instead, the set sweep value is marked by an arrow on the X axis.

With time-controlled measurements, which are selected by means of START COND TIME TICK or TIME CHART in the ANALYZER panel, the time is entered along the X axis. With these measurements, the X axis can be extended using the scan group mode. The stop value results, for example, from time = 1 s and points = 100 to yield 100 s. With scan count = 5, the monitoring period is extended to 500 s. The cursor value always indicates the total time; with scan index = 5, 400 to 500 s would be obtained in this case. As for the traces, however, the X-axis values would be in the range 0 to 99 in this

example.

## 2.10 Graphical Data Presentation (DISPLAY and GRAPHICS Panels)

The DISPLAY panel is used to set how the measurement results are graphically **presented**. Important: **what (and how)** is measured is set in the ANALYZER panel, or, with sweeps, in the GENERATOR panel. How the measurement is displayed can be changed at a later date, too. Also, curves can be retrieved from files and redrawn.

The DISPLAY panel is built up using the front-panel key DISPLAY or key combination Alt-D on the external keyboard. The menu items in the DISPLAY panel affect the GRAPHICS panel which occupies either 2/3 of the screen (part-screen graphics mode) or the complete screen (full-screen graphics) (selectable by the  $\square \leftrightarrow \square$  key or key combination ALT-Z).

OPERATION	
<b>CURVE PLOT</b>	The results of a sweep, function of time (waveform) or FFT are entered as line diagram in the Cartesian coordinate system. As a rule, two dependent variables (TRACE A and TRACE B) can be displayed above an independent variable (X AXIS). With LIMIT check activated, the tolerance masks are also included. The extensive command menu provided on the softkeys allows you to scale and zoom the display and to dimension the display using the Cursors (see 2.10.1 and 2.10.2 Trace and Spectrum Display).
<b>SWEEP LIST SPECTR LIST</b>	The measurement results of a sweep or (post) FFT are output in the form of digits. The three columns (TRACE A, TRACE B and X AXIS) are complemented by a fourth column where violations of the UPPER or LOWER LIMIT curve are marked. In full-screen graphics mode, two additional columns indicate the LIMITS (interpolated between intermediate values!) (see 2.10.3 and 2.10.4) if LIMIT CHECK has been activated (see 2.10.7).
<b>SWP LIM REP SPC LIM REP</b>	As opposed to TRACE LIST, the digit lines with measured values exceeding the tolerances only are displayed (see 2.10.3 and 2.10.4), which is possible only with LIMIT CHECK activated (see 2.10.7).
<b>BARGRAPH</b>	<p>The current measured values are displayed in analog form as bars ('signal level meter'). This type of indication is ideally suited for measurements where the relative size or change in size - and not the exact value - is desired. Max. 3 BARGRAPHS are displayed. The extreme values are marked by trailing pointers (see 2.10.5 and 2.10.6).</p> <p>The bargraphs #1 and #2 are freely selectable, the bargraph #3 is automatically assigned the following functions (in the order of their priority):</p> <ol style="list-style-type: none"> <li>1. with activated sweep: swept parameter</li> <li>2. (x-axis or sweep curve)</li> <li>3. with activated phase measurement: phase</li> <li>4. with activated frequency measurement: frequency channel 1 or 2</li> <li>5. Generator frequency (if selected generator function permits frequency to be entered)</li> </ol>



**OPERATION**

- SPECTRUM**
- PROTOCOL**
- PROTO AUTO**

With FUNCTION FFT or POST FFT selected in the ANALYZER panel, the frequency spectrum calculated by the DSP is displayed (SPECTRUM is automatically set with FFT or FILTER SIM selected in the ANALYZER panel).

With FUNCTION MOD DIST, DFD or THD selected in the ANALYZER panel, the spectrum components of the stimulus and interference products can be displayed in the form of a histogram (see 2.10.1 and 2.10.2).

In the GRAPH window, the protocol data of the digital interface are displayed. Evaluation of the protocol is made simultaneously with the respective function (see 2.10.8).

PROTO AUTO enables the automatic decoding of the channel status bits irrespective of the professional bit value (see 2.10.8 PROTOCOL Analysis).

**Mode**

- DEL BEF WR**
- MAX HOLD**
- WATERFALL**

(With FFT spectrum only)

This is to select a trace, or pair of traces (trace A and trace B). Each new trace will overwrite the previous trace(s).

This key is used to switch on the MAXimum HOLD function. FFT AVERAGE cannot be set unequal to 1 in the ANALYZER panel with OVERL/MAX H selected, see 2.6.5.12.

**Note:** *MAX Hold can only be selected if the display is switched off (Avg count 1).*

Shifts the single curves in the z-axis to obtain a spatial impression. One channel only can be traced at a time, which is why 1 or 2 must be selected under "Channel(s)" in the ANALYZER panel. To obtain a useful display, scaling is to be set as follows:

1. TRACE Top is to be set such that the upper half (or 3/5) of the coordinate system is empty (i.e. is not occupied by the first trace).
2. X-AXIS Right such that about half of the coordinate system is free.
3. TRACE Bottom is to be set above the noise limit, making noise invisible by clipping and emphasizing significant spectral components.

**Note:** *Waterfall can only be selected with one-channel analyzer.*

**Scan count**

1
>1

(With CURVEPLOT, SWEEP LIST, SWP LIM REP and BARGRAPH operation only, not with spectrum displays)

Defines the number of single traces or trace pairs to be measured and displayed. If a Z sweep is selected in the generator, the number of Z values is automatically entered in Scan Count.

A single trace or a trace pair (Trace A and B) should be measured or loaded. Each new curve overwrites the previous one. With this setting a continuous sweep (without Z axis) is performed repeatedly but only the last one is stored.

If a single-scan trace is loaded from the file, the file overwrites the current contents of the trace buffer.

If a multiscan trace is loaded from the file, only the 1st scan is loaded into the trace buffer, all others are ignored.

With this setting, not only one measurement sequence (sweep run, scan) is measured and displayed but as many as required. However, only the selected number, but not more than 17, are internally stored in or read from a file. Non-stored scans are only displayed in the curve plot and lost during rescaling, storing/loading of trace files or upon storing/loading of ACTUAL+DATA setups.

A continuous sweep (without Z axis) is terminated after the specified number of sweeps but only the last 17 sweeps are stored.

If a single-scan trace is loaded from a file, this scan is *appended* to the existing scans.

If a multiscan trace is loaded from the file, the trace buffer is *cleared* and the number of scans specified here is loaded into the trace buffer, all other scans of the file are ignored.

If more than the specified number of scans are performed, only the last (max. 17) scans are stored.

If more than 17 scans are specified, only the last 17 are stored.

For more details refer to section (see 2.9.3.3 Scan Count >1)

**Note:** Scan Count can be **increased** any time for storing more scans in the trace buffer. **Reducing** the Scan Count clears the trace buffer and provides an empty display again.

**User Label**

OFF
ON

The units and function labeling in the graphical display are automatical generated by UPL.

The user can assign his own units and function labels. This is of interest in particular for remote control if measured values were converted. The labeling is entered in UNIT/Label under Trace A/B or X axis. When User Label is switched from OFF to ON, the labeling assigned by UPL appears in the input fields and can be overwritten by the user.

## 2.10.1 Parameters for Display of Traces and Spectra (DISPLAY Panel)

TRACE A	Is used to select which measurement results are to be collected and graphically represented as TRACE A (or TRACE B) e.g. in the case of a sweep.
TRACE B	<b>Note:</b> <i>Display of the trace can be switched OFF (invisible) by means of a softkey.</i>
OFF	No measured values are collected and hence, nothing can be displayed under this TRACE.
FUNC CH1	(Function Channel 1) The results of the measurement of channel 1 currently selected in the ANALYZER panel by way of FUNCTION are used. Possible only when FUNCTION in the ANALYZER panel is not OFF.
FUNC CH2	As above, however for channel 2. (Frequency Channel 2)
FREQ CH1	Frequency meter channel 1. Possible only with FREQ/PHASE in the ANALYZER panel not OFF and OPERATION not SPECTRUM.
FREQ CH2	Frequency meter channel 2. Possible only with FREQ/PHASE in the ANALYZER panel set to FREQ and OPERATION not SPECTRUM.
PHASE	Phase meter between channel 1 and 2. Possible only with FREQ/PHASE in the ANALYZER panel set to FREQ&PHASE and OPERATION not SPECTRUM.
INP RMS CH1	RMS measurement results channel 1. Only possible if measuring function THD or THD + N/SINAD and channel 1 are set.
INP RMS CH2	RMS measurement results channel 2. Only possible if measuring function THD or THD + N/SINAD and channel 2 are set.
HOLD	Does not collect new values but continues to display the old trace. HOLD is only accepted as input if valid trace data or FFT data are provided.  A sweep stored in a file in the FILE panel (TRACE LIST) can be recalled and displayed, e.g. for comparison purposes, using this option. Sweep lists can be stored as a group of traces (Scan count >1 in the DISPLAY panel) in a file. To recall this group of traces, Scan count must also be set to this number, otherwise an error message is output. (See 2.9.1.2 Loading and Storing of Series of Measured Values and Block/List Data, and 2.9.3.3 Scan Count >1). If a pair of traces is stored in a file (with Store TRACE A + B in the FILE panel) and if this pair is loaded by means of FILE, only trace A is used and trace B is ignored. To load the pair of traces, the parameter DUAL FILE should be used.

## TRACE A/B

*(continued)*

## FILE

Sweep lists and FFT files can be loaded.

The following basic conditions must be satisfied to load a sweep list.

- The display OPERATION must be set to CURVE PLOT, SWEEP LIST or SWP LIM REP.
- All sweeps must be switched to OFF (or START COND to AUTO) or the sweep parameter (FREQ, VOLT, TIME) must be identical to the X-axis of the trace file to be loaded.

The following condition must be satisfied to load an FFT or FILTER SIM file.

- The display OPERATION must be set to SPECTRUM, SPECTR LIST or SPC LIM REP.

For loading a waveform file

- the WAVEFORM function must be set in the ANALYZER panel (this causes CURVEPLOT to be set automatically in the display).

When loading the trace file, TRACE A has the function of a "master" trace; trace B is the "slave" trace:

- The "master" trace can always be loaded as soon as the above basic conditions are satisfied. In addition to the trace data, the stored display settings including the complete X-axis are also loaded (cf. Section 2.9.1.2, menu item STORE → TRACE A/B). If a sweep has been selected, the loaded trace is interpolated on the X list specified by the sweep.
- When trace A is switched off, TRACE B becomes the "master" trace.
- Being the "slave" trace, TRACE B must conform to the X-scale of the "master" trace; i.e., only the trace data and the appropriate Y-scale are loaded. The curve is interpolated on the X-axis already specified. If this X-axis is incompatible, the "slave" trace is switched off.

## DUAL FILE

In the FILE panel, a pair of traces can be stored as a unit in a file by means of TRACE A + B under STORE. The pair of traces can be recalled by means of DUAL FILE (under TRACE A). The parameter of trace B, too, is set to dual trace and the scaling of both traces as well as any reference values or reference traces are loaded from the file.

## GROUP DELAY

GROUP DELAY can be switched on only, if FREQ/PHASE has been set to FRQ&GRPDEL in the ANALYZER panel (this is possible with two-channel measurement, only). The group delay calculated from the phase measurement is displayed).

## Filename

(Displayed with TRACE A/B FILE only)

The name of the file with a sweep or FFT to be displayed is entered. If an error occurs during loading, "NOT FOUND" is output in this line.

<b>Scale B</b>	<p><b>EQUAL A</b></p> <p><b>NOT EQUAL A</b></p>	<p>The second (dependent) measured value is displayed using the same scaling as for Trace A. Any values for UNIT, REFERENCE, SCALE, SPACING, TOP and BOTTOM need not be entered for the second axis. This requires however that the same function is selected for TRACE A and B (only the channel may be different).</p> <p>Different scaling for the second sweep.</p>
<b>Unit</b>		<p>Is used to specify the unit with which the results are to be displayed (see 2.4 Units). Recorded sweeps can be redisplayed with other units at any time. Traces loaded using TRACE A/B FILE therefore need not be drawn in the same way as they have been stored.</p>
<b>Unit/Label</b>		<p>Entry of a string which specifies a freely definable unit and axis label. The string consists of 5 characters for the unit which are centered and if need be padded with blanks, and 12 characters for the axis label which are also centered and if need be padded with blanks. There is a separate "Unit/Label" command for each trace and the x-axis.</p>
<b>Reference</b>	<p><b>MAX</b></p> <p>* <b>CURSOR</b> o <b>CURSOR</b></p> <p><b>VALUE:</b></p> <p><b>FILE</b></p>	<p>Displayed only if a relative unit is selected in the menu item "Unit".</p> <p>Selection of reference. This may be a single numeric value or a data record (reference trace). It applies to all numeric values of the trace, i.e. top, bottom, measured and limit values.</p> <p>The maximum value of the sweep is adopted once as reference value.</p> <p>The value on which the cursor is placed is adopted once (not with BARGRAPH)</p> <p>A numeral with unit is entered.</p> <p>The reference trace is loaded from the file. The file name is entered in the following line. If a pair of traces is stored in a file, trace A is loaded. If a reference trace is assigned to trace A, the reference is ignored. If Scans GROUP is selected, a group of traces is loaded. If the number of traces stored does not coincide with the Scan count number, an error message is output.</p>

Reference	
<b>OTHER TRACE</b>	<p>The reference trace is loaded with the trace data of the other trace. Every new measured value of the other trace is simultaneously entered in this reference trace and is then immediately available for representation of the new test point. If the other trace is OFF or inactive (e.g. because an invalid file name has been entered), a corresponding warning is output. If the other trace is incompatible (e.g. TRACE A FREQ CH1 and TRACE B → INP RMS CH1), a corresponding warning is output. If the other trace is set to FILE or HOLD, the compatibility is not checked.</p>
<b>MEAS CH1</b>	<p>The reference trace is cleared and then loaded with the measured values of channel 1. These are</p> <ul style="list-style-type: none"> <li>➤ function measurement results of channel 1 if trace "FUNC CH1" or "FUNC CH2" is selected</li> <li>➤ frequency measurement results of channel 1 if trace "FREQ CH1" or "FREQ CH2" is selected</li> <li>➤ input rms measurement results of channel 1 if trace "INP RMS CH1" or "INP RMS CH2" is selected</li> </ul> <p>This choice is only offered if both channels are activated and TRACE (with activated phase measurement) is not set to FREQ CH1 or PHASE.</p>
<b>MEAS CH2</b>	<p>The reference trace is cleared and then loaded with the measured values of channel 2 (as above, applying for channel 2).</p>
<b>GEN TRACK</b>	<p>The reference trace is cleared and loaded with the currently valid generator in every measurement. This is</p> <ul style="list-style-type: none"> <li>➤ the generator rms value valid at the respective test point if trace "FUNC CH1" or "FUNC CH2" is selected,</li> <li>➤ the generator frequency valid at the respective test point if trace "FREQ CH1" or "FREQ CH2" is selected,</li> <li>➤ the generator rms value valid at the respective test point if trace "INP RMS CH1" or "INP RMS CH2" is selected.</li> </ul>
<b>HOLD</b>	<p>The reference trace is not changed any more. If HOLD is selected without valid reference trace data being provided, a warning is output and the last valid reference is set again.</p>
<b>FILE INTERN</b>	<p>This option can be selected only if a reference trace was stored in the file. FILE INTERN is set automatically if a trace loaded from a file has a reference trace assigned to it.</p>
<b>REF 997 Hz REF 1000 Hz</b>	<p>The value measured at 997 Hz or 1 kHz is taken once as a reference value for a single sweep run. With FFT traces, the nearest bin (actually measured frequency line) is taken, with frequency sweeps interpolation is made between the two neighbouring points.</p> <p>If the X axis is not the frequency axis (for example in the case of level sweeps or waveform traces), an error message is output and the reference value remains unchanged.</p>

Limit Ref	
<p><b>MAX</b></p> <p><b>* CURSOR</b> <b>o CURSOR</b></p> <p><b>VALUE:</b></p>	<p>Selection of reference for calculating limit curves if the selected unit is <b>not</b> a relative unit.</p>
	<p><b>Note:</b> <i>Limit files consist of dimensionless numerals and become a physical unit only by a multiplication with the reference value. For this reason a reference value is also required for non-referenced values in the display.</i></p>
	<p>The maximum value of the measurements is taken as a reference value.</p>
<p>The value marked by the *- or o-cursor is used as a reference (not in the case of BARGRAPH).</p>	
<p>A numeral with unit is entered.</p>	

Normalize	
<p><b>VALUE</b></p> <p><b>o CURSOR</b></p> <p><b>* CURSOR</b></p>	<p>Normalizes the displayed trace, if a related (e.g., dBr or V/Vr) and a floating reference value - like OTHER TRACE, MEAS CH1, MEAS CH2 or GEN TRACK- are used. A defined value can be specified to be 0 dBr or <math>V/Vr = 1</math> by shifting the complete trace (multiplying it with the normalization value).</p>
	<p>The normalization factor is entered as a numeric value.</p>
	<p>The required normalization value is calculated by means of normalizing the y-value of the current o-cursor position. This is usually the value with 1 kHz, which implies that the cursor has been set to 1 kHz before. By acknowledging this selection, the value is entered under VALUE.</p>
<p>As above, however, the * cursor is used.</p>	

<b>Scale</b>
--------------

<b>AUTO ONCE</b>
<b>MANUAL</b>

Uses the minimum and maximum values of the current sweep for scaling of TRACE A and B (once) and rescales after changing the function using FUNCTION in the ANALYZER panel or TRACE A/B in the DISPLAY panel. The sweep or FFT start/stop values of the GENERATOR or ANALYZER panel are adopted for the X-axis. The following menu items TOP and BOTTOM or LEFT and RIGHT are no longer displayed because they have been set in doing so.

If there are not yet any measured values available, preset range limits are used for the time being and rescaled after the end of the sweep. When changing the measurement function (using TRACE A/B or FUNCTION in the ANALYZER panel with FUNC CH1/2 or GRAPH ON/ OFF with SMPTE, THD and DFD) an automatic rescaling is performed after the first measurement in the SCALE AUTO ONCE state. (Re-) START does not initiate a new scaling.

If Scan count >1 is selected, AUTO ONCE is executed only when all scans have ended (e.g. z-sweep).

The full-scale values of the new scaling are determined about 5 % lower or higher than the exact values. Using an intelligent algorithm, 'even' values appropriate for the scale are selected.

Leaves the scaling to the user.

With a new scaling the image is deleted and redrawn after the rescaling. This applies also to an FFT started by the Single key. With FFT in Continuous mode (started by Start key), however, the running FFT is still drawn, the new scaling being considered only in the next FFT.

**Note:** *If scale AUTO ONCE is selected, autoscaling is performed when switching between LIN and LOG.*

<b>Spacing</b>
----------------

<b>LIN</b>
<b>LOG</b>

Divides the Y-axis linearly.

Divides the Y-axis logarithmically. With logarithmic units (dB) selected, LIN only can be selected.

**Notes:** *If Scale → AUTO ONCE is selected, autoscaling is performed when switching between LIN → LOG.*

<b>Top</b>
------------

The menu item is displayed only with TRACE A/B SCALE MANUAL. The item serves to set the upper value of the Y-axis (of the scale for the measured values). Negative or 0 values are not permissible with SPACING LOG and logarithmic (dB-) units.

<b>Bottom</b>
---------------

(With TRACE A/B SCALE MANUAL), the menu item serves to set the lower value of the y-axis (of the scale for the measured values). The value must be smaller than that of TOP. Negative or 0-values are not permissible with SPACING LOG and logarithmic (dB) units.



**Notes on scaling the Y axis:**

- A newly selected display unit is assigned to all values from top to bottom but other units may be subsequently selected. Thus it is possible, for instance, to select a logarithmic scale (e.g. dBr) as a unit and to enter absolute units for the top and bottom values (e.g. in Volt).
- *Exception:* If a reference trace is active, entering an absolute unit for the top and bottom values is physically meaningless. For this reason no unit is offered in this case, the numeric values are assigned the unit selected under "Unit".
- If a referenced unit is set for the top or bottom value, the trace is vertically shifted when the reference value is changed.

**Left**

(With X AXIS SCALE MANUAL), the menu item sets the left value of the X-axis (of the independent value). Negative or 0 values are not permissible with SPACING LOG and logarithmic (dB) units.

**Right**

(With X AXIS SCALE MANUAL), the menu item sets the right value of the X-axis (of the independent value). The value must be selected higher than that for LEFT. Negative or 0-values are not permissible with SPACING LOG and logarithmic (dB) units.

**COMMENT**

Allows the entry of a comment with a length of max. 27 characters, which is output together with the curve in the case of OPERATION CURVE PLOT.

**X Pos**

(X Position)

Defines the X-position of the comment. X is the relative distance to the 0-point (bottom, left) in % (0 to 100) of the coordinate system.

**Y Pos**

(Y Position)

Defines the Y-position of the comment. Y is the relative distance to the 0-point in % (0 to 100) of the coordinate system. 0-point is on the left side at the bottom. The reference point for the text is the first letter (bottom, left).

### 2.10.2 Trace and Spectrum Display (GRAPH panel)

Basically, two dependent values (TRACE A and TRACE B) can be displayed above an independent value (X AXIS), the scales for TRACE A and TRACE B being displayed on the left-hand and right-hand margin, respectively (unless the same scaling has been selected by way of TRACE B, SCALE B: EQUAL A). The measurement functions selected for display are faded in on the upper margin in the form of letters.

Overrange values are not displayed (the curve is interrupted). Underrange values are indicated in the status line SWEEP INFO in the top, right corner. Measured values not fitting into the selected coordinate system are displayed as horizontal line at the top or bottom.

With THD, MOD DIST and DFD measurements, the measured values can be displayed in the form of a histogram above the frequency axis (with OPERATION SPECTRUM), the frequency axis being not true to scale and invariable.

To allow any traces to be used as reference traces or to be displayed simultaneously for the purpose of comparison, and measured by means of the movable cursors, all traces would have to have the same X-values. However, any X divisions can be used on the UPL as the values of the traces and reference traces are interpolated to the set X-axis. The interpolated values are displayed as traces or numerals. The original X and Y values are displayed only if no sweep is selected (and thus no X-axis is set). (Excepted are all limit traces; they are displayed using the original and not the interpolated values (see 2.10.7 Limit Check).)

There are two cursors marked by \* and o, respectively. They can be moved across the display using the rotary knob or the direction keys. The measured values below the cursor positions are displayed in three windows (depending on the function set, also difference values). The cursor jumps from measured value to measured value. If there are more measured values than can be displayed as points (e.g. with FFT), the maximum out of the measured values displayed on one point is displayed. Here, the cursor jumps from line to line.

Also, the cursor can be moved outside the coordinate system and indicate the appertaining values. In this case, its symbol is placed in the top corners.

If no group of traces is selected (Scan count =1), the measurement currently being taken is indicated by means of a gap moving along the trace. If several traces are displayed on the screen (Scan count >1), the gap may no longer be visible; instead, the set sweep value is marked by an arrow on the X-axis.

The current scan (with one or two traces) is selected with the PAGE UP/PAGE DOWN keys on the keyboard. The current value, i.e. the scan index, is indicated by a number between the out-of-tolerance field and the left-hand cursor-value field. The point of intersection of the cursor with the current trace (or pair of traces) is visually emphasized by means of a circle. It is thus possible to allocate the cursor values indicated in the windows unambiguously to the current scan.

With LIMIT check switched on (see 2.10.7 Limit Check), the tolerance masks are displayed, too.

An extensive command menu on the softkeys allows you to scale, zoom the display, select the cursor functions and to set markers on the single frequency lines or the harmonics of the FFT.

The cursor can be moved and the softkeys can be operated only after the GRAPHICS panel has been selected using the front-panel key GRAPH or the key combination ALT-R.

The softkey menus have max. 3 levels. The extremely left key (labeled with "BACK") always returns to the preceding menu level. Its designation is indicated above the BACK softkey and constitutes together with the text displayed in center above the remaining 7 softkeys the heading of the current menu.

Some softkeys indicate ON or OFF states, where ○ is the symbol for OFF and ● for ON.

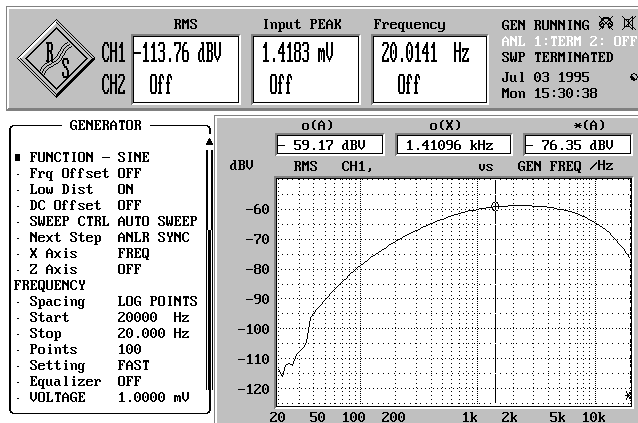

Fig. 2-39

The first two levels of the softkey menu tree are dealt with below. A third level, if any, is explained subsequently.

### CURVE

A

B

switches the display of curves or lines on or off (toggle key). Display only is affected. (With TRACE A/B in the DISPLAY panel OFF, nothing can be displayed. Changing a function (using TRACE A/B in the DISPLAY panel) switches A and B to ON.)

### AUTOSCAL

ALL

A

B

X

Rescales the X- and Y-axes using the present measured values of a sweep or the FFT. If there are no measured values, the preset range limits are used and scaled after the end of the sweep. The present display including the axes are deleted and subsequently redrawn (see also AUTOSCALE).

The left-hand trace-A axis only is rescaled, the trace A curve is redrawn.

The right-hand trace-B axis only is rescaled, the trace B curve is redrawn. Is ignored with SCALE B set to EQUAL A.

The X-axis only is rescaled (not with SPECTRUM and Analyzer FUNCTION THD, MOD DIST or DFD).

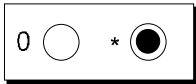

Switches alternately the \*-cursor or the o-cursor active. Only the active cursor can be moved using the rotary knob or the direction keys and can display the measured values. The softkeys pressed subsequently (HLINE, SET TO and ON/OFF) refer to the active cursor. The inactive cursor is displayed in short dashes.

The o-cursor is used for the ZOOM function and as reference for the \*-cursor and horizontal cursor. The \*-cursor can be switched over to horizontal line (not with SPECTRUM).

\* CURSOR

The subsequent softkeys serve to select the various cursor functions. The units of the numerical values are determined by the axis scaling.

A , B

Display of the measured values of curves A and B at the cursor position as well as the appertaining X-value.

Graphics	Labeling of display field	Selected softkey
	<p>oA oB <u>oX</u></p>	oCURSOR A,B
	<p>*A *B <u>*X</u></p>	*CURSOR A,B

A - B

Display of the difference value between curves A and B at the position of the cursor and of the X-value (useful only with identical physical variables).

Graphics	Labeling of display field	Selected softkey
	<p>oA-oB (unit of A !) <u>oX</u></p>	oCURSOR A-B
	<p>*A-*B (unit of B !) <u>*X</u></p>	*CURSOR A-B

\* - 0

(With active \*-cursor only). Display of the difference between the values at the positions of the \*- and o-cursor on curve A (or curve B) and the difference between the X-values.

Graphics	Labeling of display field	Selected softkey
	*A-oA *B-oB *X-oX	*-o

HLINE →

(With active \*-cursor and Operation Curve Plot only). Switchover of \*-cursor to horizontal cursor. The subsequent command level is described further below.

SET TO →

Sets the active cursor to specific values. The subsequent softkey command level is described further below.

ON/OFF

Switches alternately the cursor on and off. A deactivated cursor is no longer displayed.

ZOOM

Zooms the display in X-direction. The ZOOM function is not active with histogram indication (OPERATION SPECTRUM and simultaneously Analyzer FUNCTION THD, MODDIST or DFD).

AT o UP

Zooms the display on the X-axis by the factor 2 (repeated activation is possible). The center used is the o-cursor which is then also placed in the center. Changes the LEFT and RIGHT parameters of the X-axis in the DISPLAY panel.

AT o DOWN

Compresses the display on the X-axis to half the size (can be activated repeatedly). The o-cursor is the center, which afterwards is in the middle. Changes the LEFT and RIGHT parameters of the X-axis in the DISPLAY panel.

CEN TO o

Sets the center of the X-axis of the new coordinate system to the value of the o-cursor without zooming. Changes the LEFT and RIGHT parameters of the X-axis in the DISPLAY panel.

o TO \*

The end values of the new (zoomed) X-axis are predefined by the X-values of the two cursors which will subsequently be placed on these cursor values. Changes the LEFT and RIGHT parameters of the X-axis in the DISPLAY panel. In order to obtain a scrolling effect, the cursors can be shifted to X-values outside the displayed range; the values continue to be displayed.

UNZOOM

Restores the original X-axis, defined by X AXIS LEFT and RIGHT. UNZOOM is also performed internally when modifying and setting a parameter which changes the X-axis. Restores the original LEFT and RIGHT parameters of the X-axis in the DISPLAY panel.

UNDO

Cancels the last ZOOM action (one-time).

MARKER

TRACEA →

TRACEB →

(With FFT only). Switches the display of markers in the form of triangulars above the marked measured value on trace A (or B) ON. The functions are on the next softkey level and described below.

MORE

The functions of the third (and last) level of the softkey menu is referred to in the following:

\* CURSOR

HLINE

A

B

(With Operation Curve Plot (not with FFT) only)

The \*-cursor is switched over to horizontal line. Its Y-value and the X-values of its intersections with trace A (or B) are displayed, if available. If there are several intersections, the extreme, right-hand and the extreme, left-hand intersections are used. When changing its position via rotary knob or direction keys the cursor jumps from measured value to measured value, usually meeting exactly only 1 intersection (left or right). The other (last) intersection is no longer valid and therefore marked by an "i" in the display. With softkey B, the intersections with trace B are displayed.

Graphics	Labeling of display field	Selected softkey
	<p>*Y *XAL *XAR</p>	HLINE A
	<p>*Y *XBL *XBR</p>	HLINE B

Δ A

Δ B

The \*-cursor is switched over to horizontal line. The difference between its Y-value and that of the o-cursor is displayed. The intersections with trace A or, as the case may be, trace B are displayed (see above). Application: e.g. simple measurement of the -3-dB points.

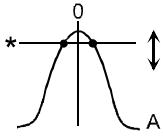
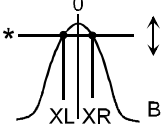
Graphics	Labeling of display field	Selected softkey
	<p>oA-*Y *XAL *XAR</p>	<p>Δ HLINE A</p>
	<p>oB-*Y *XBL *XBR</p>	<p>Δ HLINE B</p>

MARKER

A

B

MAX

o-CURSOR

VIEW OFF

With FFT only; sets the first marker (triangle marked by "X") to the maximum value of trace A (or B).

With FFT only; sets the first marker to the value defined by the o-cursor. Trace A (or B) is used.

With FFT only; deletes the first marker on trace A (or B) and the harmonics.

HARM

(Harmonics) with FFT only; sets or deletes alternately the markers 2 to 9 of the harmonics (frequency multiples) of the first marker. The values of trace A (or B) are marked. With the first marker (triangle marked by "X") being on the fundamental wave, k2 to k9, for example, are marked.

CURSOR

SET TO

MIN A

(Not with FFT). The active cursor is set to the minimum value of the sweep (in the displayed section). It is also displayed as the cursor value. The measured values of trace A (or trace B) are used.

MIN B

IMAX A

(With FFT only). The active cursor is placed on the interpolated maximum, which may be higher than the values displayed (see 2.6.5.12 FFT). This value is displayed as a cursor value, too.

IMAX B

MAX A

The active cursor is placed on the maximum value of the sweep (in the displayed section). It is also displayed as the cursor value. The Y-values of trace A (or trace B) are used.

MAX B

MARKER

(With FFT only). The active cursor is placed on marker 1 of the FFT. Its value is then displayed as a cursor value.

NEXTHARM

(With FFT only). The active cursor is placed on the next marker of the FFT. Its value is then displayed as a cursor value.

MORE

SETREF

(Set Reference)

A WITH \*

Sets the reference value TRACE A REFERENCE in the DISPLAY panel to the current value of the \*-cursor. In this case, the cursor must not have HLINE function. Effective only with relative scaling units and causes trace A to be redrawn. Applies analogously to TRACE B, where SCALE B must not be set to EQUAL A.

B WITH \*

A WITH o

Sets the reference value TRACE A REFERENCE to the current value of the o-cursor. In this case, the cursor must not have HLINE function. Effective only with relative scaling units and causes trace A to be redrawn. Applies analogously to TRACE B, where SCALE B must not be set to EQUAL A.

B WITH o



## 2.10.3 Parameters for the Display of Lists

<b>TRACE A</b>	Used to select the measurement results that are to be collected during a sweep as TRACE A (or TRACE B) and which are then displayed as a list of numbers in the GRAPHICS panel (graphics window).
<b>TRACE B</b>	
<b>FUNC CH1</b>	(Function channel 1) The results of the current measurement of channel 1, which has been selected in the ANALYZER panel by way of FUNCTION, are used. Possible only when FUNCTION in the ANALYZER panel is not OFF.
<b>FUNC CH2</b>	As above, however of channel 2.
<b>FREQ CH1</b>	(Frequency Channel 1) Frequency meter channel 1. Possible only when FREQ/PHASE in the ANALYZER panel is not set to OFF.
<b>FREQ CH2</b>	Frequency meter channel 2. Possible only when FREQ/PHASE in the ANALYZER panel is set to FREQ.
<b>PHASE</b>	Phase meter between channel 1 and 2. Possible only when FREQ/PHASE in the ANALYZER is set to FREQ&PHASE.
<b>HOLD</b>	Does not collect any new values but holds the old ones. HOLD is only accepted as input if valid trace data or FFT data are provided.
<b>OFF</b>	Switches the display in the form of a list off.
<b>FILE</b>	A sweep stored to file in the FILE panel (STORE TRACE/LIST) can be recalled and displayed, e.g. for comparison purposes, using this option.
<b>DUAL FILE</b>	The subsequent menu line is required for this purpose. Also see 2.10.1, Trace A/B FILE and DUAL FILE.
<b>GROUP DELAY</b>	The group delay calculated from the phase is used.

<b>FILE NAME</b>	(Displayed with TRACE A/B FILE only). Enter the name of the file with a sweep or FFT to be displayed. If any error occurs during loading, "NOT FOUND" is output in this line.
------------------	---

<b>UNIT</b>	Determines the unit with which the results are to be displayed (see also Section 2.4 Units). Recorded sweeps can be reprinted at any time using any other unit.  When, after selection of a new function or a new instrument, the present unit can no longer be used, the units set for the measurement in the ANALYZER or GENERATOR panels are automatically adopted for the new function.
-------------	---

**REFERENCE**

The reference value is required for the relative units and the limit curves.

**MAX**

The maximum value of the sweep is adopted once as reference value.

**o CURSOR**

The value the cursor is placed on is adopted once.

**VALUE:**

A numeric value with unit is entered.

Further settings see under 2.10.1 Reference ...

...

### 2.10.4 Display (GRAPH) of Lists

The results of an FFT or a sweep are output as numeric values using SPECTR LIST or SWEEP LIST. TRACE A, TRACE B and X AXIS are displayed in 3 columns which are complemented by a fourth column in which measurement results exceeding the UPPER or LOWER LIMIT curve are indicated by way of arrows (triangles) pointing upward or downward. To this end, LIMIT CHECK must be activated in the FILE panel. In full-screen graphics mode, the LIMITS, if active (LIMIT CHECK not OFF), are indicated in additional two columns (interpolated in the case of intermediate values).

The symbol for the o-cursor is displayed in the left edge of the screen in the line with the value on which the cursor is placed (also with trace presentation). After a new picture has been set up the cursor is placed in the center and can be moved using the rotary knob or the direction keys. When the cursor reaches the edge of the picture, the display is scrolled line for line. Any new sweep deletes an old line replacing it by a new line.

As opposed to SWEEP OR SPECTR LIST, LIM REPORT displays only those measured values exceeding the upper tolerance mask (LIMIT UP) or the lower tolerance mask (LIMIT LOW). LIMIT CHECK must be activated in the FILE panel for this purpose. Any new sweep deletes the old display completely and sets it up anew from top to bottom. If there are more lines than can be displayed on the screen, the picture segment can be shifted using the rotary knob or the direction keys.

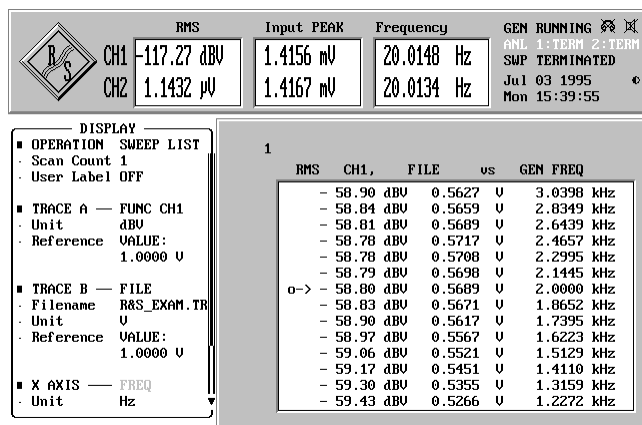

Fig. 2-40 Page/ up/down : scan select

## 2.10.5 Parameters for BARGRAPH Display

**BARGRAPH1**

Used to select the measurement results that are to be indicated as bargraph.

**BARGRAPH2****FUNC CH1**

(Function channel 1)  
The results of the current measurement of channel 1, which has been selected in the ANALYZER panel by way of FUNCTION, are used. Possible only when FUNCTION in the ANALYZER panel is not OFF.

**FUNC CH2**

As above, however of channel 2.

**FREQ CH1**

Frequency meter channel 1. Possible only when FREQ/PHASE in the ANALYZER panel is not set to OFF.

**FREQ CH2**

Frequency meter channel 2. Possible only when FREQ/PHASE in the ANALYZER panel is set to FREQ.

**PHASE**

Phase meter between channel 1 and 2. Possible only when FREQ/PHASE in the ANALYZER is set to FREQ&PHASE.

**OFF**

Switches the display off

**GROUP DELAY**

The group delay calculated from the phase is used.

**BARGRAPH X**

Displays the x-value of the current sweep. If no sweep is active, the display contains, if possible the phase, if phase measurement is switched on frequency of channel 1 or channel 2 or generator frequency (if selected generator function allows for frequency input), if frequency measurement is switched on

**UNIT**

Determines the unit with which the results are to be displayed (see also Section 2.4 Units).

**REFERENCE**

The reference value is required for the relative units.

**MAX**

The maximum value is adopted once as reference value.

**VALUE**

A numeric value with unit is entered.

...

Refer to Section 2.10.1 Reference ... for further settings.

Scale	<p><b>AUTO ONCE</b></p> <p><b>MANUAL</b></p>	<p>Uses the minimum and maximum values for scaling (once) and rescales after changing the function using FUNCTION in the ANALYZER panel or TRACE A/B in the DISPLAY panel. The menu items LEFT and RIGHT are no longer displayed because they have been set in doing so. For BAR 3, the sweep start/stop values are adopted from the GENERATOR or ANALYZER panel.</p> <p>Leaves the subsequent scaling to the user.</p>
SPACING	<p><b>LIN</b></p> <p><b>LOG</b></p>	<p>Linear spacing of the display axis.</p> <p>Logarithmic spacing of the display axis. With logarithmic units (dB) selected in UNIT, LIN only can be selected.</p>
LEFT/BOTTOM		<p>(With SCALE MANUAL,) sets the bottom left value of the display. Negative or 0-values are not permissible in combination with SPACING LOG or logarithmic (dB) units.</p>
RIGHT/TOP		<p>(With SCALE MANUAL,) sets the top right value of the display. The value must be higher than that of LEFT. Negative or 0-values are not permissible in combination with SPACING LOG or logarithmic (dB) units.</p>
AUTOSCAL		
ALL		<p>Rescales the axes of BAR1 and BAR2 using the current maximum values of the measurement and BAR3 using the sweep start/stop values. If there are no measured values, the range limits are used.</p>
BAR1		<p>Only BAR1 is rescaled (otherwise as ALL).</p>
BAR2		<p>Only BAR2 is rescaled (otherwise as ALL).</p>
BAR3		<p>Only BAR3 is rescaled (otherwise as ALL).</p>

### 2.10.6 BARGRAPH Display (GRAPHICS Panel)

BARGRAPH indication is used to display the current measured values in analog form as bars. Bargraph display is suited for applications in which the relative magnitude or changes in magnitude are significant and not the exact value. A maximum of 3 bargraphs can be displayed. Values exceeding the displayable range are indicated by a triangular arrow on the left or right side.

The peak values measured in the monitoring interval (after Start) are marked by a pointer, identifiable by the thin line, its left end marking the minimum value, the right end the maximum value. The pointer can be reset using the Start key.

With limit check activated in the FILE panel (LIMIT not OFF), also the limit values (interpolated in the case of intermediate values) are displayed in the form of brackets. When changing the independent axis (e.g. the frequency with sweeps), the brackets are automatically set to the appropriate values. The bargraph changes its colour when the limits are exceeded.

The minimum and maximum values during the monitoring interval are displayed as numeric values above the bargraphs. In full-screen mode, the difference between maximum and minimum value is indicated, too.

BARGRAPH3 represents the current X-value of the set sweep, the measured frequency or phase or the generator frequency. The field remains empty when no sweep is started.

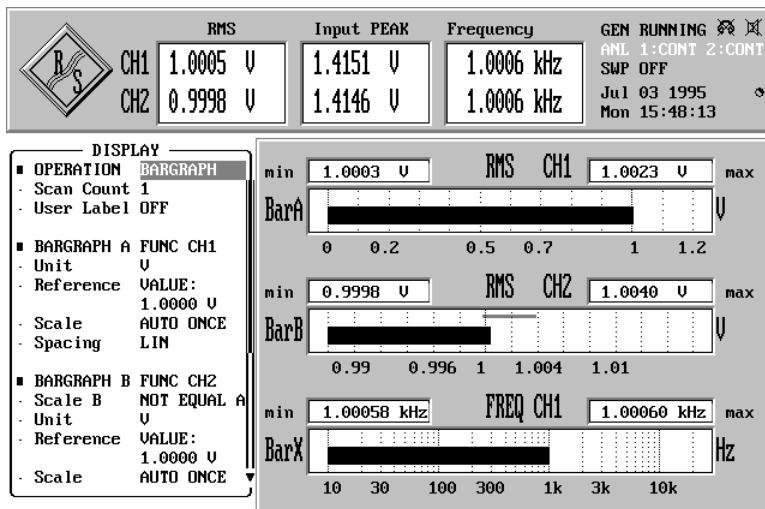

Fig. 2-41 Bargraph display

### 2.10.7 Limit Check

The following commands are available under the heading LIMIT CHECK in the DISPLAY panel which is called by pressing the DISPLAY key or the key combination Alt-D on the external keyboard.

A lower and an upper limit or, as the case may be, a limit curve can be defined for the measurement, each measured value of a sweep or an FFT being compared with the limits. With trace display, they are included in the coordinate system; with bargraph indication, they are marked by lines (varying in position). With SWEEP LIST, lines containing measured values out-of-tolerance are marked by a triangle. With LIM REPORT active, measured values violating the limits are indicated or stored. (See also OPERATION command in the DISPLAY panel in Section 2.10 and STORE TRACE/LIST in the FILE panel in Section 2.9.1.2.)

With CURVE PLOT, exceeding of limits is marked in the top, left edge by an arrow pointing downwards (lower limit is violated) or by an arrow pointing upwards (upper limit or limit line is exceeded). A single exceeded limit marks the whole sweep as out-of-tolerance. Unlike underrange values, overrange values (measured with overdriving) are out-of-tolerance values.

When relative units are used, the limits are converted using the reference value in the DISPLAY panel.

<b>Check</b>	Determines which trace (or bargraph) is checked.
<b>TRACE A</b>	Either trace A (or BARGRAPH 1) or trace B (or BARGRAPH 2) can be checked.
<b>TRACE B</b>	
<b>TRACE A + B</b>	
	Both curves are checked together for a limit violation. As there is only one tolerance band, this is only useful if the measured physical quantity is the same. To ensure that this is the case, this selection item is only be available when "Trace B EQUAL A" is selected. The reference value of trace A is used.

<b>Mode</b>	
<b>LIM LOWER</b>	The lower limit is checked.
<b>LIM UPPER</b>	The upper limit is checked.
<b>LIM LOW&amp;UP</b>	The lower and upper limits are checked.
<b>OFF</b>	Limit check is OFF.

**Lim Upper**

<b>Lim Lower</b>	Determines how the lower/upper limit value is defined.
<b>VALUE</b>	A value with unit which is constant for all X values is entered for the upper/lower limit. If a relative unit is entered, the appertaining reference value is taken from the DISPLAY panel (TRACE A/B REFERENCE).
<b>OFF</b>	

A lower/upper limit curve is defined below.

**Filename**

This serves to load the file with the limit curve. If mode LIM LOWER or LIM LOW&UP is switched on, the curve for the lower limit can be loaded, which contains the extension .LLW to the file name. In mode UPPER or LIM LOW&UP, this is the file with extension .LUP.

These files contain x-y pairs, with the y-value being a factor which is multiplied with the set reference value (TRACE A (or B) REFERENCE VALUE from the DISPLAY panel) to obtain an absolute value. By changing the reference value, the tolerance band on the y-scale can be offset. The following measurements are relative measurements, which is why there is no reference value and only the units % and dB: THD, THD+N, MOD DIST, DFD, WOW&FL.

The limit value must be entered in %, e.g. 5 for 5% for the upper limit value, a lower limit (LIM LOWER) being not required.

Only a few sampling points are required. The intermediate values necessary for tolerance monitoring of a sweep or an FFT are interpolated at the start of a sweep. This requires an indication whether the axes for x and y are linear or log, to ensure that correct values are calculated for segments not running horizontally or vertically (slanted segments). These lines become elliptical in the other division. If points are required before or after the last sampling point, the last slopes of the interpolation are continued.

In the case of full-screen mode, the interpolated limit values are indicated for every measured value in the graphics window with OPERATION SWEEP/SPECTR LIST or SWP/SPC LIM Report.

**Note:** *The file format is described in the example data R&S\_EXAM.LLW and R&S\_EXAM.LUP in the form of comments. The parameters of the measured points are arranged in blocks one after the other, i.e. first the y-values then the x-values. In the files R&S\_E212.LLW and R&S\_E212.LUP the parameters of the measured points are arranged in pairs, i.e. y- and x-values in one line.*



**2.10.8 PROTOCOL Analysis**

When a digital analyzer is used, the audio data contents can be monitored and displayed as well as the transmitted information analyzed. The latter is the channel status and user data, the meaning of which depends on their application and protocol. Additionally, this protocol analysis includes display of other (transmission) errors. To activate the protocol analysis, PROTOCOL measurement function must be selected in the ANALYZER panel (see 2.6.5.15).

Screen display:

The screen (consisting of 16 lines of 50 characters each) is divided into two sections:

- TOP: Fixed protocol elements:
  - Validity: shows the state of the validity bit in the respective channel. If the two channels are equal, L=R is indicated in addition.
  - Parity errors: indicates the error status (yes/no).
  - Errors: indicates the errors that have occurred:
    - LOCK: PLL not locked
    - CONFIDEN: cannot be decoded (eye opening less than half a bit)
    - CODING: coding error detected
    - NONE: no error
- BOTTOM: These 13 lines can be matched to the currently used protocol with the aid of a protocol control file.

Changing status bits are displayed and output in red.  
 Bits that have not changed since the latest output are displayed in green.  
 Comments (PRINT command) are displayed in yellow.

The colours for the protocol can be changed in the OPTIONS panel under TRACES COLOR/LINE (see 2.15.5.4 Graphics Display with Selectable Colours)

**OPERATION**

**PROTOCOL**  
**PROTO AUTO**

In what form the channel status or user data are displayed depends on which protocol file (Proto File) is selected.

The channel status data are visualized by automatic decoding of the professional bits:

- If bit #0 is set (professional mode), the protocol file for the professional mode R&S\_AES3.PAC will be loaded. The remaining bits will be decoded in the professional mode.
- If bit #0 is reset (professional mode), the protocol file for the consumer mode R&S\_CONS.PAC will be loaded. The remaining bits will be decoded in the consumer mode.

**Note:** For the user data, the protocol file must always be explicitly named, ie if display of the user data is selected ('Source USER L' or 'USER R'), PROTO AUTO has the same effect as PROTOCOL.

Protocol Analysis: Channel Status Left

Validity: L=R    1=Y		Parity errors: _____	
		Errors: NONE	
Byte:	=====	AES3	=====
0:	Format:	professional	Mode: linear PCM
	Emph:	J.17	Source: unlocked
	Rate:	not ind	
1:	Chanmod:	stereo	Usermod: AES18
2:	Auxmod:	20 no	Length: 23/19 R:0
3-4:	Vector:	12	Grade: 2
	enh. Rate	96 kHz	Scaling: 1/1.001
6-13:	Origin:	UPL_	Destin: R&S_
14-21:	Local:	01234567	Time: 12:45:00
22:	Reliaby:	0-5:1    6-13:0	14-17:0    18-21:0
23:	CRC L:	_____	CRC R: _____
Measured sample rate: 96000.2			

↑ Text entered by UPL

---

↓ as of here:  
user-defined

This example was generated with the protocol file R&S\_aes3.pac.

**Note:** Channel status data are decoded in the professional mode (and encoded in the GENERATOR panel) according to the AES3 recommendation of 1 November 98, which has preliminary status.

<b>Source</b>	Select the data to be displayed.
<b>CHAN STAT L</b>	Channel status data left are displayed.
<b>CHAN STAT R</b>	Channel status data right are displayed.
<b>USER L</b>	User data left are displayed.
<b>USER R</b>	User data right are displayed.

With CHAN STAT L or R, the following line is read out on the screen (for OPERATION PROTOCOL):

**Proto File**

Proto File selects the interpretation file for channel status data.  
 Selection from: file name, preset type of file: \*.pac

Upon entering a file name, one of the following actions is performed on the channel status data:

- decoding in the consumer or professional mode (R&S\_CONS.PAC or R&S\_AES3.PAC),
- displaying in binary code (R&S\_BIN.PAC),
- displaying in hexadecimal code (4 bit grouped together to a hex figure each) (R&S\_HEX.PAC),
- displaying in ASCII mode ((R&S\_ASC.PAC)).

Description:

The protocol information is displayed in two sections; the two upper lines are displayed in a fixed format and contain information on validity, parity, other errors and differences between the two channels. The other lines are formatted using the specifications in the file, the individual bits being assigned any output text you desire. This file can be modified to suit any protocol you desire.

Example: see R&S\_AES3.PAC

File format: same as with USER L or USER R, see below

**Note:** This line does not appear in OPERATION PROTO AUTO; the correct protocol file is loaded instead.

With USER x, the following lines are displayed:

**FORMAT**

Format selects the interpretation mode.

- BINARY**
- HEX**
- ASCII**
- FILE**

User data are represented in a 01010 sequence.  
 Representation is block aligned.

User data are represented as a hexadecimal, numerical sequence.  
 Representation is block aligned.

User data are represented as text.  
 Representation is block aligned.

Interpretation, block aligned

With FILE, the following line is displayed:

**Proto File**

Proto File selects the interpretation file for user data.

Selection from: file name, preset type of file: \*.PAU

File format:

The protocol file has the following structure:

One line for each operation, followed by parameters which are separated by commas. The parameters allow the representation of any bits (1 to 32) from the selected data, the output position being freely selectable. Each line must not contain more than 255 characters.

Operations:

PRINT: Text output (independent of data)

Example:

```
PRINT 26, 5, "Usermod:"
```

(in column 26, line 5 the text "Usermod:" is entered)

VALUE: Output of values, either as hex number (default) or as text provided that an assignment is present.

Example:

```
VALUE 17, 3, BIT:2-4, 0="not ind", 4="no empf",  
6="50/15 "
```

(in column 17, line 3, the contents of the three bits (2,3,4) are represented as hex (or text, in case the value is 0, 4 or 6)

```
VALUE 17,11, CRC – L – ERR
```

(in column 17, line 11, the contents of the CRC left frequency counter is represented)

**Note as to the output width:**

*If there are text assignments, the longest text determines the output width; In case there are no text assignments, the number of bits to be represented determines the output width.*

As a data source, the following specifications are permissible:

- 'BIT' followed by ':' and definition of the bits:
  - a number from 0 to 191: single bit
  - an interval (e.g. 4-9): combined sequence of bits, max. 32 bits permissible
- 'CRC\_L\_ERR': error indication of CRC\_error left.
- 'CRC\_R\_ERR': error indication of CRC\_error right.
- 'MEASURED\_RATE': measured sample rate (represented as a 5.1-digit floating number (e.g. '48001.2')

BINARY: same as VALUE, however default output as bit pattern

TEXT: Text output (in ASCII) using a number of letters determined by the number of selected bits; each TEXT operation allows only 32 bits to be represented; for longer text outputs, several subsequent text lines are to be used.

Example:

TEXT 17, 8, BIT:48-79  
 (in column 17, line 8, the contents of the 32 bits is represented as text)  
 Characters that cannot be printed are replaced by '?' or, if '0', by '.'.

TIME: Time output (in the form of 12:45:56) of the selected number divided by the specified rate. Number/rate are interpreted as seconds since midnight.

Examples:

TIME 35, 9, BIT:144-175, RATE:48000.0  
 TIME 35, 9, BIT:144-175, RATE:SET – RATE

(in column 35, line 9, the contents of the 32 bits are represented as time (e.g. 12:34:45)

'RATE:' Should correspond to the sample rate, can be specified as floating number.

As an alternative, the following specifications are also possible:

MEASURED \_ RATE: measured clock rate  
 SET \_ RATE: clock rate set in the panel

### 2.10.9 Switching between Full-screen and Part-screen Mode

Part-screen graphics mode offers the possibility of complementing the graphical representation with another panel. The large measured value display on the upper screen edge is maintained, too. In full-screen graphics mode, the graphics has been scaled up to occupy the complete screen. The only differences between part-screen and full-screen mode are the two additional columns with the limits for the output of lists (SWEEP/SPECTR LIST and SWP/SPC LIM REPORT) and the display of the difference between minimum and maximum value with BARGRAPH, which are offered in full-screen mode only.

After having selected the GRAPHICS panel using the GRAPH key (or key combination Alt-R), you can choose between full-screen and part-screen mode using the front-panel key  $\square \leftrightarrow \square$  (or key combination Alt-Z) or by clicking the mouse (see also 2.3 General Instructions for Use and 2.3.1 Panels).

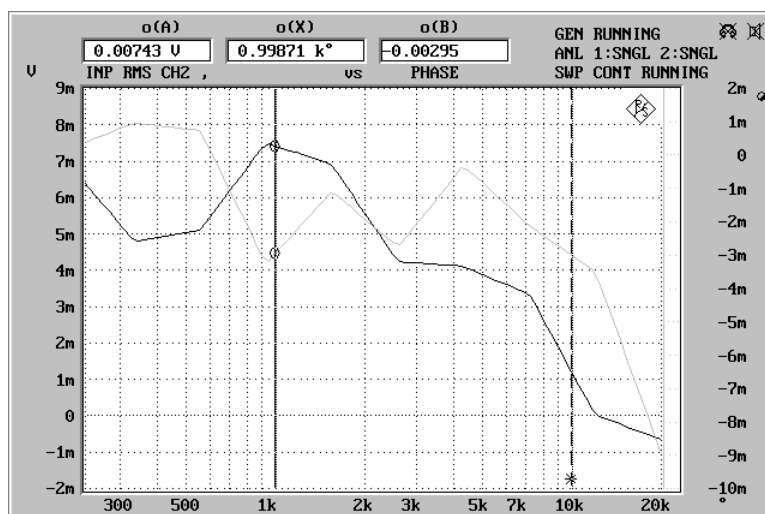

Fig. 2-42 Full-screen display

## 2.11 Starting and Stopping Measurements or Sweeps

### 2.11.1 Overview of Measurement and Sweep Systems

Basically, a differentiation is made between measurements and sweeps:

- Measurements, in the narrower sense, are understood to be single or continuous measurements of frequency, phase, input peak, or one of the measurement functions. The latter include S/N measurements, which can be activated during the AC level measurement functions (RMS, peak and quasi-peak), and in which the measurement is first performed with and then without a generator signal and the two results are then referenced to each other. The FFT function, too, is handled as a measurement, and so is the post-FFT function, which can be activated for some measurement functions although the relevant frequency lines are represented graphically or in the form of tables (similarly to sweeps).
- Sweeps are test runs in which the individual measurements are triggered by predefined generator or analyzer settings or by external events. Generator and analyzer sweeps are defined either by entering the start and stop values, the spacing and the points/step or by means of a sweep list. With both methods, a list of settings (along the X axis) is defined, which is executed after the sweep is started. In the case of generator sweeps, the list may be two-dimensional, i.e. include two variable generator parameters. This is referred to as Z sweep because the Z axis is swept in addition to the X axis. External sweeps (adjustable in the ANALYZER panel under "Start Cond"), on the other hand, have no fixed X axis. Instead, the X axis is defined by an external voltage or frequency or by a time tick. The sweep system will be activated when a sweep is switched on.

Measurements and sweeps are controlled by means of control keys START (Ctrl F5), SINGLE (Ctrl F6) and STOP/CONT (Ctrl F7), and by specific events referred to as abort events. The control keys and abort events control the measurement system when the sweep system is inactive (no sweep switched on). When the sweep system is active (generator, analyzer or external sweep switched on), the selected sweep is controlled by the control keys and abort events, and the sweep in turn controls the measurement system.

#### **Abort event:**

Definition:

Any event that renders a current measurement or sweep invalid. Occurs, if settings in the GENERATOR, ANALYZER or FILTER panels and in the relevant sections of the STATUS panel, which influence the measurement or sweep, have been modified.

#### **Effects:**

- The current measurement or sweep is aborted and restarted.
- A completed (single) measurement is restarted.  
(Note: This is valid only for manual control, no restart is done under remote or automatic control.)
- A completed (single) sweep is set "invalid" (upper right of status display).
- A completed (single) sweep normally remains unaffected in order to make it possible for the user to draw the single scans of a multiscan trace with changed UPL settings. Only if sweep settings are changed by the "abort event" (e.g. changing of start/stop, number of sweep points) the sweep is set "invalid" (status display upper right in display).

### 2.11.2 Switching Measurement Modes On and Off

UPL can measure up to six parameters simultaneously and display them numerically or graphically. These parameters are:

- Measurement functions of channels 1 and 2
- Input peak or rms of channels 1 and 2
- Frequency of channels 1 and 2, or frequency of channel 1 and phase difference between channels 1 and 2

Measurement modes can be switched off

- directly by user entries (channel selection, switching off of "Input Disp", "Frequency" or "Function" in the ANALYZER panel); this will be indicated by "OFF" in the window for the corresponding measured value,
- indirectly by selecting a test function, an analyzer instrument or an input that is not compatible with the selected measurement mode (measurement modes selected in the ANALYZER panel but not physically feasible, e.g. frequency measurement with the DC measurement function on, are marked by "-----" in the window for the corresponding measured value).

In the (single) measurement mode, all measurement functions that are switched on and active are performed. A measurement is completed when all relevant results (including a settling period, if applicable) are available. Only then can a sweep be stepped or a triggered result be fetched in the remote control mode. This also means that the measurement speed of the UPL as a whole is determined by the speed of the slowest measurement mode or function. To achieve maximum measurement speed, it is recommended that only the measurement modes really needed be switched on.

**Note:** *In analyzer 110 kHz channels 1 and 2 are measured sequentially by which the measured time nearly doubles for 2 channel operation compared to 1 channel measurement.*

The display of measured values can be switched off completely irrespective of the selected measurement mode. In this case, the status displays, too, are switched off. Switch-off is effected by selecting the "Meas Disp" menu item in the OPTIONS panel or by pressing the Ctrl D hotkey on the external keyboard. Switch-off of the display results means a substantial reduction of measurement time. This mode is useful, for example, if only the generation and representation of sweep traces and spectra is of interest and not the output of individual measured values.



### 2.11.3 Operating States of Measurement System (No Sweep Active)

The operating states of the measurement system are displayed in the upper right corner of the ANL WAIT FOR TRIG: The analyzer waits for the trigger condition set with START COND (cf. 2.6.4).

ANL1:  2:

Status information separate for analyzer channel 1 | 2:

- OFF: channel switched off, no status information
- SNGL: single measurement running
- CONT: continuous measurement running
- TERM: single measurement terminated
- STOP: measurement interrupted

There are further messages indicating, for example, operating states relating to running measurements (e.g. RANG) or to terminated measurements (e. g. OVER in case no valid result was obtained due to OVERRANGE). See section 2.3.4 for further details on these status displays.

#### Continuous measurement:

The system operates with continuous measurements as the default mode. The UPL is set to this mode after switch-on. The UPL goes through all active measurement functions asynchronously until one of the following events occurs:

- SINGLE key is pressed: Switch over to single measurements is made. A measurement already started will always be completed. When all measurements are completed, the system stops in the TERMINated status. To reactivate the continuous measurement mode, press START or STOP/CONT.
- STOP/CONT key is pressed: The current measurement is stopped and the system is brought to the STOP status. To reactivate the continuous measurement mode, press START key or press STOP/CONT key again.
- START key is pressed: The current measurement is aborted, the non-return pointers and the min./max. values of the BARGRAPH as well as FFT averaging are reset, and the continuous measurement is restarted.
- Occurrence of an abort event (see 2.11.1): The current measurement is aborted and continuous measurement is restarted.

#### Single measurement:

Each type of measurement is performed only once, then the system stops in the TERMINated status. This status does not necessarily mean that a valid result was obtained. If an error occurs during a measurement, the message "Input? Press Show-IO" appears in the window for the corresponding measured value, and an NAN value (Not A Number, 9.97e37) is read via remote and automatic control. A single measurement will be restarted, after completion of the previous measurement, by pressing the SINGLE key or by the occurrence of an abort event.

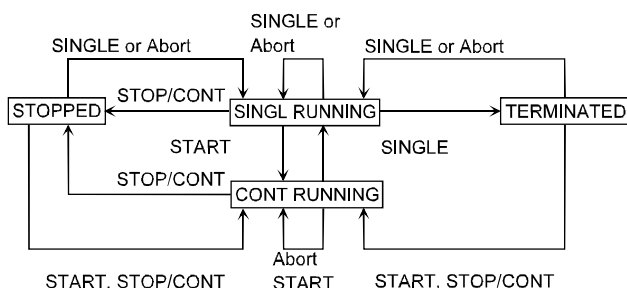

Fig. 2-43 Status diagram of measurement system (no sweep active)

### 2.11.4 Overview of Sweep Modes

The UPL features a variety of sweep modes which are briefly described in the following:

**Predefinable sweeps:**

- Generator sweeps
  - Time-synchronous sweeps (DWELL sweeps)
  - Sweeps synchronized with the analyzer (AUTO sweeps)
  - Manual sweeps (MANU sweeps)
- Analyzer sweeps
  - Sweeps synchronized with the analyzer (AUTO sweeps)

**External sweeps:**

- Time-tick sweeps
- Time-chart sweeps
- External frequency sweeps
- External level sweeps
- External level trigger

All of the above sweeps can be performed as single or as continuous sweeps. All predefinable sweeps can be performed as parameter sweeps with a constant increment or as list sweeps.

All generator sweeps can be performed as one- or two-dimensional sweeps (X or Z sweeps) provided that there is more than one sweepable parameter for the selected generator function.

External sweeps have no fixed X-axis. The X value for each measurement point is determined during the sweep.

One-dimensional sweeps can be performed as single sweep or as group of traces, two-dimensional sweeps can be performed as group of traces only. Single or group traces can be selected under menu item "Scan count" in the DISPLAY panel:

- With count = 1, only one trace is shown for every sweep; the old trace is successively erased as the new trace is drawn.
- With count >1, all traces recorded as from START are superimposed on top of each other. The last 17 traces are internally stored and can be rescaled if required.

With manual sweeps, the GRAPHICS panel will be activated automatically when a sweep is started. After starting a sweep, each sweep point must be triggered separately by means of the rotary knob or the cursor keys. Sweep stepping has priority over the current measurement being performed, i.e. the generator will be set to the sweep point next selected even if the previous measurement is not yet completed.

External level trigger can be regarded as an intermediate between a sweep and a measurement. On the one hand, this function behaves like an external one-point level sweep, on the other hand, the measured value is not stored in the trace buffers and therefore cannot be represented as a sweep curve or list.

### **2.11.5 Switching Sweeps On and Off**

The various sweep modes are selected directly in the associated panels of UPL:

- Generator sweeps under SWEEP CTRL in the GENERATOR panel
- Sweeps of the tracking filters of the RMS SEL function under SWEEP CTRL in the ANALYZER panel
- External sweeps under START COND in the upper section of the ANALYZER panel

Before a sweep is switched on, it must be ensured that no other sweep is active.

If another sweep is active, an error message is output prompting the user to switch the sweep off that is not needed.

After switching a sweep mode on, the measurement system will continue to perform continuous or single measurement; only by starting the sweep will the sweep system take over and control the measurement system.

When switch-off is made during a running sweep, the system will return to the continuous measurement mode.

### 2.11.6 Operating States of Sweep System

The operating states of the sweep system are displayed in the upper right of screen:

SWP OFF	sweep system switched off
SWP INVALID	sweep invalid due to changes of parameters or because sweep is not yet started
SWP CONT RUNNING	continuous sweep running
SWP SNGL RUNNING	single sweep running
SWP MANU RUNNING	manual sweep running
SWP TERMINATED	single sweep terminated
SWP STOPPED	sweep was stopped, can be continued.

#### Continuous sweeps:

Continuous sweeps are started by pressing the START key. When the stop value of a sweep is attained, restart is made from the start value. This is continued until one of the following events occurs:

- In continuous sweeps with Scan count >1: when the number of sweep runs defined in "Scan count" is completed, the sweep system goes to the "SWP TERMINATED" status.  
*Note:* With Z sweeps, the number of Z-axis points is transferred to the DISPLAY panel as the lower limit of "Scans".
- SINGLE key is pressed: switchover to single sweep is made. The trace currently drawn is completed, then the system goes to the "SWP TERMINATED" status. To reactivate the continuous sweep mode, press START key. To activate the continuous measurement mode, press STOP/CONT key.
- STOP/CONT key is pressed: the current sweep, and the system, are stopped ("SWP STOPPED" status). To reactivate the continuous sweep mode, press START key (sweep is restarted), or press STOP/CONT key again (sweep is continued). To activate the continuous measurement mode, switch the sweep mode off.
- START key is pressed: the current sweep is aborted, the non-return pointers and the min./max. values of the BARGRAPH as well as FFT averaging are reset, and the continuous sweep is restarted.
- Occurrence of an abort event (see 2.11.1): the current sweep is aborted and continuous sweep is restarted.
- The sweep mode is switched off: switchover is made to the continuous measurement mode.

#### Exceptions:

- Level- or frequency-triggered external sweeps: trigger values that are closer to the start value by more than the difference relative to the latest measured value are detected as a retrace and the sweep is restarted.
- Level-triggered external sweeps: the level must fall below the start value after each externally triggered measurement for the level trigger to be ready for the next measurement.
- All external sweeps: when the STOP/CONT key is pressed, the current sweep is terminated (SWP TERMINATED status). Continuation of that sweep is not possible. (cf. 2.11.7 Operating Modes of External Frequency and Level Sweeps and 2.6.4 Starting the Analyzer).

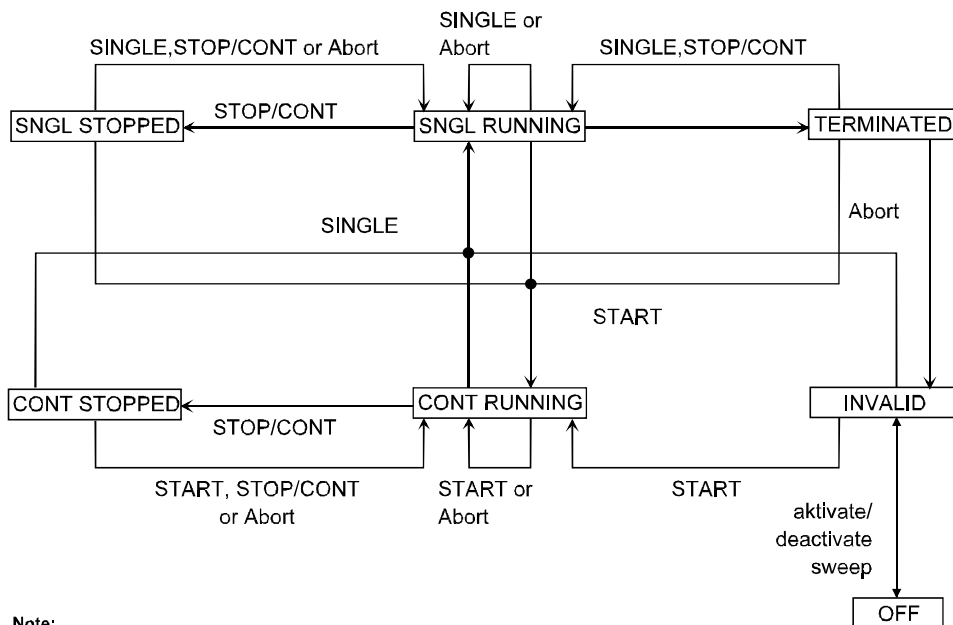

**Note:**

The states "SNGL STOPPED" and "CONT STOPPED" are briefly indicated in the status display with "STOPPED".

Fig. 2-44 State diagram of sweep system

**Single sweeps:**

Single sweeps are started by pressing the SINGLE key and are performed only once. When the stop value (of the X axis) is attained, the system goes to the SWP TERMINATED status. With Z sweeps, therefore, each new Z point (and the corresponding X-axis sweep) must be triggered separately. A running single sweep is stopped or aborted by one of the following events:

- SINGLE key is pressed: the current single sweep is aborted and then restarted.
- STOP/CONT key is pressed: the current measurement and the sweep system are stopped (SWP STOPPED status). To reactivate the single sweep, press SINGLE key (sweep is restarted), or press STOP/CONT key again (sweep is continued).
- START key is pressed: the current sweep is aborted, the non-return pointers and the min./max. values of the BARGRAPH as well as FFT averaging are reset, and continuous sweep is started.
- Occurrence of an abort event (see 2.11.1): the current single sweep is aborted and then restarted.
- The sweep mode is switched off: switchover is made to the continuous measurement mode.

After termination of a single sweep, the following can happen:

- SINGLE key is pressed: the single sweep is restarted.
- STOP/CONT key is pressed: switchover is made to the continuous measurement mode. To reactivate the single sweep, press SINGLE.
- START key is pressed: the non-return pointers and the min./max. values of the BARGRAPH as well as FFT averaging are reset, and continuous sweep is started.
- Occurrence of an abort event: the sweep system goes to the SWP INVALID status.
- The sweep mode is switched off: switchover is made to the continuous measurement mode.

Deviating from these general status transitions, there are the following **special conditions** for some sweep modes:

- Level- or frequency-triggered external sweeps: trigger values closer to the start value than the last measured value are ignored. Trigger values beyond the stop value cause the current single sweep to be terminated (resulting in SWP TERMINATED status).
- Level-triggered external sweeps: a single sweep is considered terminated following the first externally triggered measurement (resulting in SWP TERMINATED status). Pressing the SINGLE key makes the level trigger ready for the next trigger event.
- All external sweeps: when the STOP/CONT key is pressed, the current sweep is terminated (SWP TERMINATED status). Continuation of that sweep is not possible.

### Summary: key functions

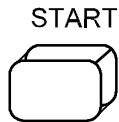

Start continuous or manual sweep (only with active sweep system, see 2.5.5.2 Sweeps) and active measurements.

Digital analyzer: AES/EBU receivers are reset if a lock error has occurred.

**Sweep system active:**

Resets sweeps (peak-, average values and non-return pointers are reset and graphical representation deleted) and starts sweeps; new state: RUNNING

With manual sweep selected, any new sweep setting must be triggered using the rotary knob.

While the sweep is running, any entries in the GENERATOR, ANALYZER or FILTER panel or in the corresponding sections in the STATUS panel cause the sweep to be aborted. Permissible keys (not changing the state):

- softkeys
- rotary knob

**Sweep system inactive (sweep state OFF):**

Resets measurements (averaging, peak-, average values and non-return pointers are reset) and (re)starts continuous measurement.

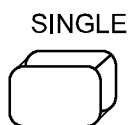

**Sweep system active:**

In the sweep states SNGL RUNNING, MANU RUNNING, STOPPED, TERMINATED or INVALID:

- Starts a single or manual sweep

In the sweep state CONT RUNNING:

- Switches from continuous to single sweep

**Sweep system inactive (sweep state OFF):**

Key refers to single/continuous measurement:

- Analyzer state SNGL RUNNING, STOPPED or TERMINATED: starts a single measurement
- Analyzer state CONT RUNNING: switches from continuous to single measurement.



**Sweep system active:**

In the sweep state CONT RUNNING or SNGL RUNNING

- Aborts the sweep; new state: STOPPED

- Analyzer is switched to "wait for trigger".

In the sweep state STOPPED:

- Continues the sweep without reset; new state: SNGL RUNNING or CONT RUNNING

In the sweep state INVALID or TERMINATED:

- Continuous measurement is started.

**Sweep system inactive (sweep state OFF):**

Key refers to single /continuous measurement

- Analyzer state ...RUNNING: aborts the measurement immediately
- Analyzer state STOPPED or TERMINATED: starts continuous measurement.

### 2.11.7 Operating Modes of External Frequency and Level Sweeps

With external sweep, the analyzer has to decide independently, whether a new measured value is applied, which is to be recorded and displayed. It is important that the x-axis is continuously rising or falling. A reversal of the sweep direction must be interpreted as retrace or ignored. The question is: when does a new sweep begin and what are "outliers" which can be ignored.

The following settings are of importance for an answer:

Start condition

Stop condition

Possibly settling

Starting the measurement using the START key

Terminating the measurement using the STOP key

- An external sweep which is started using the **SINGLE** key starts as soon as the start condition is reached and terminates after the stop condition has been reached. TERMINATED is then displayed, i.e., the sweep is terminated. In order that the end of an external sweep will be recognized, the stop condition must be set such that it can be recognized with certainty. For example, by a frequency sweep up to 20 kHz, the stop condition must be set a little before 20 kHz, which means that the entire length of the sweep cannot be acquired. With a single measurement, measured values are only plotted in ascending order. Stray measurement values which would lead to a backward signal are ignored. In this operating mode, it is recommended to set Scan count to 1 in the DISPLAY panel.
- An external sweep which is started using the **START** key starts as soon as the start condition is reached and is not terminated automatically. Every discontinuity in the measurement sequence or the reaching of the stop condition causes the actual sweep to be aborted. If the start condition is again satisfied, the trace up to this point is completely deleted and a new sweep is plotted. In this operating mode it is thus not allowed that an external sweep contains any stray measurement values which would lead to a backward signal. If the stop condition is set such that it is never reached (e. g. to 25 kHz when the sweep only goes up to 20 kHz), the external sweep is actually plotted up to the last measured point. If several external sweeps should be measured in a quasi-continuous operating mode and displayed, the display mode Scan count >1 must be selected in the DISPLAY panel. Each new sweep start then increments the scan index, all sweeps are simultaneously displayed and can be evaluated.



### 2.11.8 Several Sweep Traces Displayed in a Diagram

To be able to compare different sweeps, it is useful to display them in a single diagram. This can be done in different ways in the DISPLAY panel:

**Note:** Unless specified otherwise, a generator frequency sweep without Z sweep is assumed for all examples:

SWEEP CTRL	AUTO SWEEP
X axis	FREQ
Z axis	OFF

- Two separate traces can be displayed with an identical or different Y axes. Each trace may contain up to 17 single scan curves. Provided they contain dimensioned values, the traces may be referenced to each other so that the deviation of each sweep point can be directly read (e.g. in dB).

TRACE A	FUNCT CH1
Unit	dBr
Reference	OTHER TRACE
TRACE B	FUNCT CH2
Unit	V
Reference	VALUE

Trace B is displayed in V, Trace A is referenced to Trace B and displayed in dBr.

- A trace file containing the sweep trace or a trace group of a previous (reference) measurement can be loaded into each of the two traces. Thus it is possible to compare

- a currently measured sweep trace to a reference trace, or

TRACE A	FUNCT CH1
TRACE B	FILE
Filename	ref2trcb.trc (contains 1 mono scan, for instance)

- two previously measured and stored sweep traces.

TRACE A	FILE
Filename	ref2trca.trc (contains 1 mono scan, for instance)
TRACE B	FILE
Filename	ref2trcb.trc (contains 1 mono scan, for instance)

- Each trace can be referred to a reference trace. In this case the trace is displayed with the selected *relative* unit. Two traces of this kind can be simultaneously displayed in one diagram.

TRACE A	FUNCT CH1
Reference	FILE
Filename	ref3trca.trc (contains 1 mono scan, for instance)
TRACE B	FUNCT CH2
Reference	FILE
Filename	ref3trcb.trc (contains 1 mono scan, for instance)

The SINGLE key starts a 2-channel sweep measurement

- Within one trace, a group of up to 17 scans can be processed, i.e. rescaled and stored. Any number of scans can be displayed; the number can be specified under Scan Count. Each scan can be triggered using the SINGLE key. After each scan (TERMINATED is indicated as sweep status), the user may not only change settings on the DUT but also any parameter on the UPL (except sweep parameters). Thus it is possible, for instance, to record a scan in another measurement mode (THD all even, THD all odd) or with another measurement function (THD, THD+N), provided the basic unit of the measurement function is not changed. (It is not possible, for instance, to make up a trace with scans of RMS measurements and THD measurements.) The measured curves can also be stored as a single trace.

Scan Count	3
FUNCTION	THD
Meas Mode	ALL EVEN
SINGLE key starts	scan #1
Meas Mode	ALL ODD
SINGLE key starts	scan #2
FUNCTION	THD+N/SINAD
Meas Mode	THD+N
SINGLE key starts	scan #3

**Notes:**

- If Scan Count > 17 is selected, only the last 17 of the recorded scans can be processed. Previous scans are only visible on the screen and lost during rescaling or storing..
- Pressing the START key clears all previously recorded or loaded scans.
- To clear previous scans and to record a single one, press the START and then the SINGLE key

5. Using the SINGLE key, scans may be added to a multiscan trace or individual scans can be replaced, provided a valid sweep is set. By loading a stored (reference) multiscan trace (dual traces are also possible), a new sweep measurement can be added to the curves of a reference trace (and stored).

Scan Count	10
TRACE A	DUAL FILE
Filename	ref5trc.trc (contains 5 stereo scans, for instance)
TRACE A	FUNCT CH1
SINGLE key starts	scan #6

**Note:** Pressing the START key clears all previously recorded or loaded scans.

6. Single scans can be loaded together with a measured or loaded multi- or single-scan trace provided the X and Y axes are compatible.

Scan Count	10
TRACE A	DUAL FILE
Filename	ref5trc.trc (contains 5 stereo scans, for instance)
Filename	ref61trc.trc (contains 1 stereo scan, for instance)
Filename	ref62trc.trc (contains 1 stereo scan, for instance)
Filename	ref63trc.trc (contains 1 stereo scan, for instance)
Filename	ref64trc.trc (contains 1 stereo scan, for instance)
Filename	ref65trc.trc (contains 1 stereo scan, for instance)

This (stereo) multiscan made up to 10 stereo scans can be stored again under a new file name (under STORE TRACE A+B in the FILE panel).

**Note:** When combining a multiscan and several single scans, the multiscan must be loaded first. Combining two or more multiscans is not possible.

7. Single scans can be loaded or recorded together with an existing Z sweep. For this purpose Z sweep must be switched off in the GENERATOR panel after completion and Scan Count be increased by the number of additional scans.

Z axis	VOLT	(in GENERATOR panel)
POINTS	10	(in GENERATOR panel)
Scan Count	10	(display only)
TRACE A	FUNCT CH1	
TRACE B	FUNCT CH2	

The START key triggers the Z sweep. When the sweep is terminated:

Z axis	OFF	(in GENERATOR panel)
Scan Count	12	
TRACE A	DUAL FILE	
Filename	ref71trc.trc	(contains 1 stereo scan)
Filename	ref72trc.trc	(contains 1 stereo scan)

**Note:**

*Only single scans (mono or stereo) can be recorded or loaded with a recorded or loaded multiscan.*

8. When a setup stored as ACTUAL+DATA contains a complete sweep, the setup is loaded with all its recorded sweep traces. The sweep can be continued with the SINGLE key provided a sufficiently high Scan Count has been set.

Thus an ACTUAL+DATA reference setup can be created, for instance, to which the sweep trace of the DUT can be added. This new trace group can of course be stored again as an ACTUAL+DATA setup or as a multiscan trace file.

**Note:**

*The START key clears all previous sweep traces.*

## 2.12 Display of Selected Inputs / Outputs

SHOW I/O

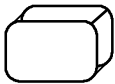

Shows a picture of the UPL front panel; the active inputs and outputs are marked by arrows.

The LC display shown indicates which inputs and outputs have been selected on the UPL rear panel.

Pressing the key while the message "Input? Press SHOW I/O" is being output in (at least) one of the measured value displays causes the messages on measurement errors, which may have occurred, to be displayed, too (see Section 2.3.6 Error Messages).

## 2.13 Fast Switch-off of Outputs

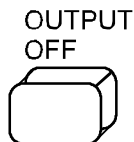

Switches off all outputs (incl. the clock lines of the digital interfaces). To protect the analyzer input after overloading (input voltage into  $300\ \Omega$  and  $600\ \Omega$  higher than 25 V), the generator output is automatically switched off and the OUTPUT OFF LED lights as if the OUTPUT OFF had been pressed..

States:

- The level of the digital outputs is set to 0 V; no clock.
- Analog outputs are terminated (impedance is retained); output level = 0 V.
- Digital inputs supply no clock.

When switched off, the lines can be reactivated only by pressing the OUTPUT OFF key again. After an overload of analyzer inputs, measurements can be continued if the overload has been eliminated and the input impedance switched to  $200\ \text{k}\Omega$ .

An LED indicates the state of the key. LED on signifies OUTPUT OFF. Additionally the generator status display indicates "Output Off", so this state is noticable in case of using an external monitor and no attention is paid to the UPL .

## 2.14 Printing / Plotting / Storing the Screen Contents

Use the H COPY (hardcopy) key on the front panel to initiate printing, plotting or storing to file of the screen contents displayed at the instant the key is pressed.

The following menu items are available in the OPTIONS panel under the heading SCREEN HARD COPY.

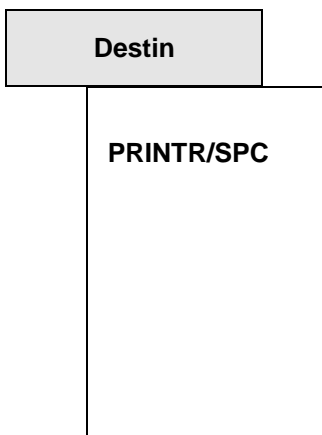

(Destination) indicates where and in which format the printout should be performed. The printout is triggered with the H COPY key (see below):

Graphics are output in the form of pixel data to a printer using its special print format (abbreviation **SPeCial**). Printing is performed in the background while the UPL is accomplishing other tasks.

**Note:** *Printing is in progress in the background while the UPL is performing further measurements. This output can be accelerated by stopping the measured value output or the sweep using the STOP/CONT key.*

Destin	(continued)
<b>PLOTTR/HPGL</b>	Control characters are output in HP-GL format, a language specifically defined for plotters, yet also supported by some printers (see Destin = PRINTR/HPLG below). HP-GL format offers the advantage of the resolution being determined by the output unit instead of by the UPL screen (slashes without disturbing stages). The size of the output is defined by the configuration of e.g. the plotter as all vectors are plotted relative to the configuration (see under P1, P2 "point" and "size/rotate" in the plotter manual).
<b>FILE/PCX</b>	Screen hard copy to a file using PCX format. The PCX format (pixel format) was defined by the ZSoft company for PC Paintbrush and is accepted by most programs capable of loading graphics (MS WINDOWS programs and others).
<b>FILE/HPGL</b>	Screen hard copy to a file using HP-GL format.  Apart from most plotters (eg R&S DOP 2), some laser printers and some programs with graphics import capabilities also understand the HP-GL format. It is vector-oriented and offers the advantage of the resolution being determined by the output unit instead of by the UPL screen (slashes without disturbing stages). In addition, the size of the output is defined by the configuration of eg the plotter as all vectors are drawn relative to the configuration (see also plotter manual).  <b>Note:</b> <i>If HPGL data are to be used as a drawing in other programs, the result obtained is not always optimal. A few widespread (Windows) programs ignore e.g. the text format instructions or do not properly present the colour and the dashed lines. Therefore, programs are available on the market for matching and printing purposes.</i>
<b>PRINTR/HPGL</b>	Screen hard copy to a printer using HP-GL format. Control characters are output in HP-GL format, a language specifically defined for plotters, yet also supported by some printers. In most cases printers have to be enabled to interpret HPGL information by a sequence. This prolog is provided in a prolog file with the name GL_PRO.LOG. There is also a file with the name GL_EPI.LOG for the epilog. These files are located in the UPL\REF directory and may be changed by the user. For each character to be sent the files contain 1 - 3 (ASCII-) characters with following space interpreted as 1 Byte in decimal notation. As example the files HPLJ3_P.LOG and HPLJ3_E.LOG are delivered which initialize and reset the printer laserjet3 as desired. All files mentioned can be found in the subdirectory \UPL\REF.
<b>PRINTR/PS</b>	Screen hard copy to a printer using PostScript format.
<b>FILE/PS</b>	Screen hard copy to a file using PostScript format.
<b>FILE/EPS</b>	Screen hard copy to a file using encapsulated PostScript format. Colors and line styles for PostScript Outputs see 2.14.4.1 PostScript Configuration File PS.CFG

<b>Copy</b>
-------------

<b>SCREEN</b>
<b>CURVE/GRID</b>
<b>CURVE</b>

(With Destin PLOTTR/HPGL, FILE/HPGL, PRINTR/HPGL, PRINTR/PS, FILE/PS and FILE/EPS only)

The complete screen contents is output, including all labels and cursor displays as well as the curves/bargraphs with scales. In part-screen graphics mode, the display of the current measured values and a panel are additionally included. The softkeys and operator guidance line are masked out and replaced by date, time and R&S logo.

The curves/bargraphs including the scales and scale labels are output, however not the cursors and other labels.

The curve(s) displayed on the screen are transmitted only, thus reducing the time required for output.

**Note:** If the 3-panel display is selected, an UPL PostScript copy is **not** prepared for CURVE/GRID and CURVE (empty space) as this display does not contain a trace.

Default: SCREEN

<b>Printname</b>
------------------

<b>drivename</b>
------------------

(With Destin PRINTR/SPC only)

For most laser and ink-jet printers as well as for dot-matrix printers with 9 or 24 pins, a printer driver can be selected as described below which converts the internal graphics (pixel-) format into control characters for the connected printer with graphics capabilities.

To print out in colour, select the appropriate colour printer (colour). Otherwise select the type (B/W). The R&S PDN printer corresponds to the type Fujitsu DL 2000 series.

If the new printer drivers, version 2.11 and later are used, it is possible that the size of figures printed out will be different than they previously were. The size of the print-out can be set by selecting a different resolution with the new command Prn Resol and the commands X Scaling and Y Scaling. The size of the print-out can be read out in cm with Prn Width and Prn Height. Because it is possible that a changed resolution Prn Resol can change the background colour of the frame of the GRAPH panel and of the measurement result display field such that any text no longer stands out enough, the colour of the background can be switched to white using the new command Frame Col.

Printer 0 (default printer) has a particular meaning. It represents the printer which the user selected last. Loading a setting from file (SETUP) does not overwrite the type selected by the user, if this printer 0 is set in the setup.

**Note:** Printing is performed in the background while the UPL is already carrying out further measurements. To speed up the output, stop the measured value output or the sweep using the STOP/CONT key.

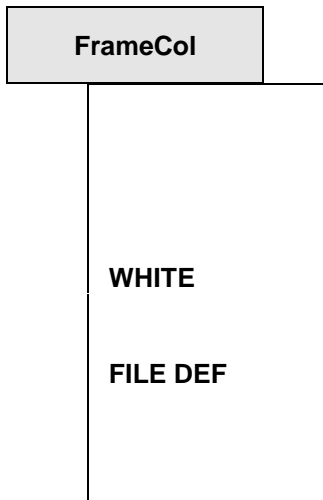

(Only with Destin = PRINTR/SPC, FILE/PCX, PRINTR/PS, FILE/PS, FILE/EPS)

Selecting the background colour of a GRAPH panel frame and the measurement result display for printing out the display contents or copying them to a file.

WHITE should be selected if a grey background is too dark for easy reading.

Colour defined in files.

Destin = PRINTR/SPC, FILE/PCX

Colour No. 2 (backgrnd frames) defined in files

UPL\REF\PRN\_BW.PLT (BW printer) or \UPL\REF\PRN\_CL.PLT (colour printer) is used.

Destin = PRINTR/PS, FILE/PS, FILE/EPS

The colour information for the frames of the GRAPH panel is taken from the PostScript configuration file \UPL\REF\PS.CFG, key word "Background Frame Color" .

Default: WHITE

**Comment**

ON

OFF

(Only with Destin PRINTR/SPC, PRINTR/PS, FILE/PS, FILE/EPS)  
 Defines if a comment is to be printed together with the screen contents.

Destin = PRINTR/SPC:  
 After pressing H COPY (CTRL F8), a selection box appears with the following options: create comment, edit comment, and generate screen hardcopy.

Destin = PRINTR/PS, FILE/PS, FILE/EPS  
 Pressing the H COPY key causes a window to be opened, where text can be entered or edited and a selection can be made whether the text should be inserted as a headline (TITLE) **above** the UPL plot or as a comment (SUPPLEMENT) **below**:

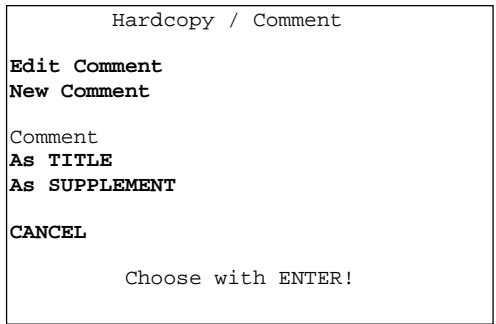

TITLE and SUPPLEMENT cannot be entered simultaneously.

Two text lines in Times New Roman Bold are reserved for the TITLE. A variable number of text lines (5 to 28) in Times New Roman can be entered as a SUPPLEMENT, depending on the orientation (PORTRAIT | LANDSCAPE) and the selected number of plots per page (Plots/Page). (See gray areas in the drawing under plots/page further down).

After pressing H COPY, a screen hardcopy is generated without a comment.

Default: ON

**Left Mrgn**

(Only with Destin PRINTR/SPC)  
 Margin of a hard copy

Specified range: 0 to 80 characters

**Note:** *Not all printers support the positioning of the graphics printout!*

Default: 10



**Prn Resol**

- LOW
- MEDIUM
- HIGH

(Only with Destin PRINTR/SPC)

Whether a resolution can be set and which one depends on the printer used. The resolution affects the size of the printing format. The actual size of the printing format is shown in the lines Prn Width and Prn Height.

- Low resolution (e.g. 75 dpi)
- Medium resolution (e.g. 150 dpi)
- High resolution (e.g. 300 dpi)

Default: HIGH

**X Scaling**

**Y Scaling**

(Only with Destin PRINTR/SPC)

Each printer has a specific resolution in dots/inch of the X and Y axes which, in conjunction with the screen resolution, may not always yield a suitable print format. To obtain a well-balanced ratio for the X and Y axes and to make optimum use of the available sheet area, some printers require scaling of the X and Y axes (preferably in integer multiples), as well as the assignment of a suitable print format (landscape or portrait).

**Note:** When using non-integer multiples, pixels are suppressed or printed several times, which may degrade the quality of the hardcopy.

The actual size of the printing format is shown in the lines Prn Width and Prn Height. For an orthomorphic projection, a width/height ratio of  $640/435 = 1.47$  must be set.

Specified range: 0.1 to 10 for X and Y axes

**Orientatn**

- LANDSCAPE
- PORTRAIT

(Only with Destin PRINTR/ SPC, PRINTR/PS, FILE/PS and FILE/EPS)

= Horizontal format

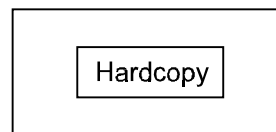

= Vertical format

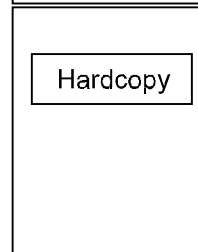

**Note:** PostScript printouts (up to 6 pictures/page) are automatically placed optimal with no regard to selected orientation; see Plots/Page below!

Default: LANDSCAPE

Color	(Only with Destin PLOTTR/HPGL, FILE/HPGL, PRINTR/HPGL, PRINTR/PS, FILE/PS and FILE/EPS)
ON	<p>Destin = FILE/HPGL: Information is stored in <b>colours</b> in the file referred to as "Filename".</p> <p>Destin = PLOTTR/HPGL, PRINTR/HPGL: Relation of colors to <b>color pens</b> see 2.14.2 Output in HP-GL Format</p> <p>Destin = PRINTR/PS, FILE/PS and FILE/EPS Information, which scan or which line will be painted in which color, in which line style and in which line width, is taken from file C:\UPL\REF\PS.CFG (see 2.14.4.1 PostScript Configuration File PS.CFG).</p>
OFF	<p>Destin = FILE/HPGL: Information is stored in <b>black-and-white</b> mode in the file referred to as "Filename".</p> <p>Destin = PLOTTR/HPGL, PRINTR/HPGL: Only <b>one color pen</b> is used.</p> <p>Destin = PRINTR/PS, FILE/PS and FILE/EPS: Curves, bargraphs and linegraphs in gray shades. Information, which scan or which line will be painted in which <b>shades of gray</b>, in which line style and in which line width, is taken from file C:\UPL\REF\PS.CFG (see 2.14.4.1 PostScript Configuration File PS.CFG).</p> <p>Default: OFF</p>

<b>Filename</b>
-----------------

(with destinations FILE/PCX, FILE/HPGL, FILE/PS and FILE/EPSONly)  
 Filename under which the PCX, HPGL or PostScript information is stored.

**Destin = FILE/PCX**

A PCX file with the extension \*.PCX is created under the specified file name.

**Destin = FILE/HPGL**

A HPGL file with the extension \*.GL is created under the specified file name.

**Destin = FILE /PS:**

A PostScript file with the extension \*.PS is created under the specified file name. This file can be sent in DOS (e.g. copy TEST.PS PRN:) to a PostScript printer.

**Destin = FILE /EPS:**

An Encapsulated PostScript-File with the extension \*.EPS is created under the specified file name. It differs from a \*.PS file only in the first and second line (printed in bold in the example below):

Example:

```
%!PS-Adobe-3.0 EPSF-3.0
%%BoundingBox: 45 205 559 733
```

The BoundingBox contains information about dimensions and position of the image in the PostScript default coordinate system in pixels (one pixel = 1/72 inch = 0.35 mm) and informs the program executing the image integration on the size and position of the plot.

Data 45 205 559 733 from the above example specify the X and Y coordinates of the bottom left-hand and top right-hand corner of the plot in the PostScript default coordinate system.

To avoid this name having to be entered in the OPTIONS panel every time a printout is triggered, the user is queried on storing a file under the name of an already existing file, whether

- this file should be overwritten as from now (without any further query),
- the file should **not** be stored (and therefore not overwritten),
- a new file name should be generated by an automatic increment of the (end) number of the file name displayed in the OPTIONS panel.

**Notes on automatic increment:**

- If the name does **not** contain a number, **one** number is added (starting with 1).
- If the filename contains **at least one** number, the numbers are considered spacers and incremented as long as there is no filename overflow (new filename contains more characters than the original one).
- When the last possible number is exceeded, an error message is output.

**Examples for automatic increment:**

```
SCREEN.PCX → SCREEN1.PCX    ...    SCREEN9.PCX
SC1BW.PCX  → SC2BW.PCX     ...    SC9BW.PCX
SC06COL.PCX → SC07COL.PCX  ...    SC99COL.PCX
```

<b>Plot on</b>	(With Destin PLOTTR/HPGL, PRINTR/HPGL and PRINTR/PS only) Select the interface for HP-GL output.
<div data-bbox="260 365 499 577"><b>COM2</b></div> <div data-bbox="260 577 499 701"><b>LPT1</b></div> <div data-bbox="260 701 499 813"><b>IEC BUS</b></div>	<p>The printer is connected to the serial COM2 interface (RS-232). Data transmission parameters for transmitter (UPL) and receiver (printer) must be identical. The parameters are set in the UPL with the COM2 PARAMETER commands in the OPTIONS panel and on the printer normally by means of slide switches.</p> <p>Some plotters and most of all printers can also be operated using the (parallel) printer interface. This setting is required especially for laser printers with HP-GL interpreter or PostScript printer.</p> <p>Some plotters and printers offer an IEEE-Bus interface. The bus address of the plotter/printer is set with the subsequent menu line 'IEC Adr.'</p> <p>Default: COM2</p>
<b>IEC Adr</b>	(With Destin PLOTTR/HPGL or PRINTR/HPGL only, if 'Plot on = IEC Bus' is selected)  IEEE-Bus address of plotter or printer connected.
<b>Prn Width</b>	(Only with Destin PRINTR/SPC, display function only) Width of the printing format in cm.  An orthomorphic projection of the printing format results when the width/height ratio is $640/435 = 1.47$ (435 is the height of the printing format in pixels without the softkey row).
<b>Prn Height</b>	(With Destin PRINTR/SPC, display function only) Height of the printing format in cm.
<b>Paper Size</b>	(With Destin = PRINTR/PS, FILE/PS or FILE/EPS only) Paper format  The UPL plots are optimally positioned for paper format A4 (21 cm * 29.6 cm) and made up of 600 * 845 pixels (one pixel = 1/72 inch = 0.35 mm) in the PostScript default coordinate system.  The UPL plots are optimally positioned for paper format LETTER (21.6 cm * 27.9 cm) and made up of 617 * 797 pixels.  Default: A4
<div data-bbox="260 1547 499 1693"><b>A4</b></div> <div data-bbox="260 1693 499 1771"><b>LETTER</b></div>	

**Plots/Page**

Number of UPL plots to be positioned on a PostScript page.

When two or more UPL plots (Plots/Page ≥ 2) are printed on a page, the HCOPY key opens up a window where the page to be printed and the positions of the UPL plots are displayed:

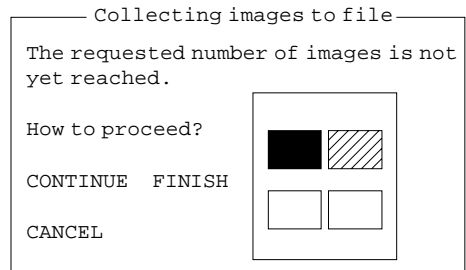

Filled-out box: the image has been already positioned  
 Hatched box: this image is being processed  
 Empty box: these images remain to be positioned

This window also allows the PostScript output to a printer or file to be aborted. Already positioned images are retained.

Automatic positioning, depending on paper orientation:  
 Orientatn = PORTRAIT

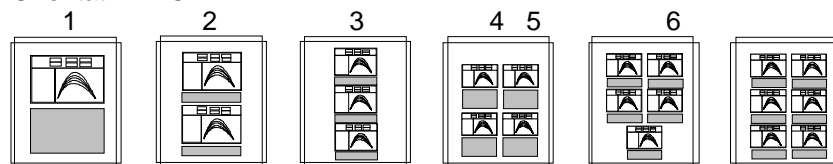

Orientatn = LANDSCAPE



Specified range: 1 to 6  
 Default: 1

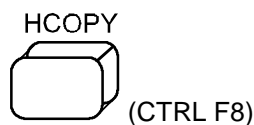

If Comment OFF is selected, pressing H COPY triggers a hardcopy without comments.

If Comment ON is selected, a dialog box opens after H COPY has been pressed. It is then possible to create a new comment for the printout, to edit an existing one or to actually trigger the hardcopy. In this box it can also be decided whether the hardcopy should be printed

- with or without comment
- with or without form feed.

**Note:** With form feed suppressed, several screen copies may be printed on the same page.

While a print procedure is in progress, pressing H COPY opens a dialog box where the printer output can be stopped or continued. A new screen copy can only be started after the previous one has been either terminated or aborted.

There are 4 kinds of outputs available; the user can determine the colour representation in different ways:

### 2.14.1 Screen Copy to Printer (pixel-oriented)

If dialog or selection boxes are active on the screen, their content is printed too. Thus particularly error messages or help texts can be printed.

Besides, an additional comment of max. 1500 characters can be entered via a dialog box and also printed out. This comment is also stored as additional file under the same name but with the extension ".CTX" when a COMPL SETUP is stored and loaded, too, when this setup is loaded. The comment file can be edited using a text editor.

Specify the type of device used for printout of the hard copy in the OPTIONS panel. Activate this panel by pressing the OPTIONS key or key combination ALT-O on the external keyboard.

If display of the cursors and their associated values in the display fields is not desired, the pointers can be switched off. Select OFF in the softkey menu under \*-cursor and o-cursor.

#### Starting a screen copy:

Press the H COPY key (or CTRL-F8 on the external keyboard) if **no** printout is in progress. UPL requires a few seconds to prepare the screen copy and then continues with the measurements while printing is taking place in the background.

Different dialog boxes may be displayed when the hardcopy key is pressed:

- "Printer not ready" (error message):  
The connected printer is not switched on, it is OFF-LINE or the printer is not connected at all. After eliminating the fault, hardcopy can be restarted.
- "Hardcopy already in progress!":  
A screen copy is being made. Prior to starting a hardcopy the previous procedure must be terminated or interrupted.
- "Hardcopy / Comment".  
A comment or form feed can be added to the screen copy. If this is not desired, the dialog box can be blanked by selecting "Comment OFF" in the OPTIONS panel.

#### Speeding up a screen copy:

A hardcopy is in progress in the background while the UPL continues with the measurements. Copying can be speeded up by stopping the result output or sweep with the STOP/CONT key.

The print command can be output via remote control using the HCOPY:WAIT command. In this case printing is performed in the foreground and the time required for printing only depends on the speed and the buffer size of the printer. The program is continued when the printing procedure is terminated. This mode is recommended when several copies are to be made in succession as in this case it can be ensured that a new copy is only started after the previous one has been completed.

#### Aborting a screen copy:

A stroke of the H COPY key during printing opens a dialog box with the aid of which the current copy procedure can be stopped. Printing is stopped while the dialog box is displayed on the screen.

- If the procedure is aborted **before** the actual printout is started, i.e. during its preparation, the printer output is not started.
- If the procedure is aborted while the printout is **in progress**, all characters sent to the printer before the stop will be printed. The printout of these characters, which are already in the printer buffer, can only be stopped at the printer itself, i.e. by switching the printer off.

**Colour handling**

Pixel-oriented data on printer via printer driver for ,e.g., a hard copy of screen

Colour printers use another colour system than the screen (additive colour system red, green, blue with screen in contrast to subtractive colour system, e.g., cyan, magenta, yellow and black with printers). Also, the print-out of a yellow curve on a black background on white paper leaves something to be desired. Therefore, the colours are converted and can be adapted to user requirements. The desired colour for each of the 16 possible colours is read from the file PRN\_CL.PLT, which can be edited by the user.

The only way to utilize shades of gray for differentiation purposes on black and white printers is to leave out individual points. This process, which is called dithering, is controlled by the file PRN\_BW.PLT. The file contains cells of 8 x 4 points for each "gray" pen and can also be changed by the user to meet his needs. The colour 10 (Trace B) is dithered only, if the printer resolution exceeds one printer point per screen pixel.

Both files described above are located in the directory \UPL\REF and contain a description of their contents in the form of comments.

The colour No. 2 is used for the background of the frames and is drawn light-gray on the screen. If the black inscription does not contrast enough with this background, the latter can be set to WHITE using the command FrameCol. The colour specified in the file is no longer used, as is the case with selection of FILE DEF.

### 2.14.2 Output in HP-GL Format

Vector-oriented outputs in HP-GL format are usually output to plotters (Destin = PLOTTR/HPGL), however some laser printers also support the HP-GL format (Destin = PRINTR/HPGL), e.g. for plotting measurement traces. The output data can be filed, too (Destin = FILE/HPGL).

The colours for screen output and the assignment of the plotter pens can be looked up in the table below:

Table 2-38 Colours of screen output and assignment of plotter pens

Function/ type	UPL-LCD	UPL colour monitor	Plotter pen	Recommended colour
Panel	black	black	1	black
Trace A	black	green	2	green
Trace B	grey	yellow	3	blue
Axes B	grey	yellow	3	blue
Scales	grey	red	4	light red (thin line)

Prior to output of the HPGL data and vectors an initialization sequence is transmitted to the drawing device at the selected interface or to the file. With plotters, this sequence may be the information about P1/P2 points (sheet or drawing size) or on the sheet format (portrait/ landscape). Printers usually require an initialization sequence to be able to interpret HPGL information. If Destin = PRINTR/HPGL is selected this sequence is loaded in a prologue file designated GL\_PRO.LOG. There is also an epilogue sequence, which is designated GL\_EPI.LOG. These files are stored in the UPL/REF directory and can be modified by the user as required. They contain, for each character to be sent, 1 to 3 (ASCII) characters followed by a blank. This sequence is interpreted as 1 byte in decimal notation. HPLJ3\_P.LOG and HPLJ3\_E.LOG are supplied as sample files for initialization and reset of Laserjet3 printer. All files referred to are included in the \UPL\REF directory.

### 2.14.3 Output in PCX Format

Outputs in PCX format to file for further processing in other programs (Destin = FILE/PCX).

The PCX file format contains a palette information. In this version used by UPL it consists of 16 entries, which assign the 16 colour types one colour, each, by means of indicating the respective red, green and blue portions. With black/white printout (Color OFF), only 16 black/gray/white hues are assigned. These palettes are filed in the UPL\REF directories under the names PCX\_BW.PLT and PCX\_CO.PLT. They can be edited by the user if other colours are required. The files contain comments indicating which pen is used for which colour.

The colour No. 2 is used for the background of the frames and is drawn light-gray on the screen. If the black inscription does not contrast enough with this background, the latter can be set to WHITE using the command FrameCol. The colour specified in the file is no longer used, as is the case with selection of FILE DEF.



### 2.14.4 Output in PostScript Format

Outputs in vector orientated PostScript format on a PostScript capable printer (Destin = PRINTR/PS) or on file for further processing (Destin = FILE/PS) or integration into other programs (Destin = FILE/EPS).

PostScript is a frequently used graphics format for use with high-quality terminals, e.g. laser printers. The PostScript format implies a complete programming language with commands permitting a high-quality graphics hardcopy to be made irrespective of the printer type, provided the printer is equipped with a PostScript option.

Upon a stroke of the HCOPY key, UPL generates a plot of the screen content or of parts thereof with the aid of suitable PostScript commands. These commands are sent to the PostScript printer either directly or via the LPT1 or COM2 interface, or they are stored in a file (\*.PS) which may be processed by users familiar with PostScript and viewed on the screen of a PC with the aid of a *previewer*.

This procedure should be adopted in the development phase of the PostScript copy to save paper and toner.

An Encapsulated PostScript file (\*.EPS) can also be created. This file allows the UPL plots to be integrated into another PostScript file, document or graphics representation (see section 2.14.4.2 Integrating and Output of PostScript Files).

Frequently used previewers are **GhostScript**, **GhostView** and **GSview**. They are available as free-ware on the Internet under the address <http://www.cs.wisc.edu/~ghost/>.

Up to 6 different UPL plots including head line or comments can be stored in a PostScript file according to a fixed pattern, format A4 or LETTER, PORTRAIT or LANDSCAPE, colour or monochrome print and the desired screen section being selectable.

PostScript settings are done in the OPTIONS panel:

Information about traces and lines to be printed and colour/shade of gray, line pattern and line width to be used can be seen in the PostScript configuration file PS.CFG (see section 2.14.4.1 PostScript Configuration File PS.CFG).

#### Overview of PostScript commands in the OPTIONS panel:

```
SCREEN HARD COPY ----
Destin      PRINTR/PS      Output of PostScript format to printer
            FILE /PS      Output of PostScript format to file (*.PS)
            FILE /EPS     Output of Encapsulated PostScript format to file (*.EPS)
Color       ON | OFF
Copy        SCREEN      | CURVE/GRID | CURVE
Comment     ON          | OFF
Paper Size  A4          | LETTER
Orientatn  LANDSCAPE   | PORTRAIT
Plot on     COM2        | LPT1          For Destin PRINTR/PS only
Plots/Page 1...6
Filename    A:\UPL.PS   For Destin FILE /PS only
            A:\UPL.EPS  For Destin FILE /EPS only
```

### 2.14.4 1 PostScript Configuration File PS.CFG

The PostScript configuration file C:\UPL\REF\PS.CFG is a text file which contains all information about colour, gray level, line width and line pattern for

- curves of TRACE A (Scan 1 to 17),
- curves of TRACE B (Scan 1 to 17),
- limit curves (upper, lower)
- Y grid (low, medium and high priority)
- X grid (low, medium and high priority)

With **logarithmic scales** the grid line priority

"high" has the values ..., 0.1, 1, 10, ...,

"medium" the values ..., 0.5, 5, 50, ... and

"low" is used for all other lines.

With **linear scales** the assigned grid line priority depends on the start and end value of the scale and is therefore difficult to predict.

**The file has to be edited with an ASCII editor in the DOS operating system.**

Several comment lines in the header of file PS.CFG inform on permissible line patterns, colours, gray shades and line widths.

## Example of a PostScript configuration file PS.CFG

```

# The following linestyle strings are available:
# ----- or _____, -----, ..... , .-.-.-
#
# The following color strings are available:
# red, green, blue, yellow, magenta, cyan,
# black, gray9, gray8, gray7, gray6, gray5,
# gray4, gray3, gray2, gray1, white
#
# The following gray levels are available:
# 0.0 (black) ... 1.0 (white)
#
# The following width values are available:
# Values > 0.0
#
#
#           ----- Line -----
#           Style   Color   Gray Width
TRAC A
Scan1:  _____ red     0.1  1.0
Scan2:  -----  green   0.2  1.0
Scan3:  .....   blue    0.3  1.0
Scan4:  .-.-.-  cyan    0.4  1.0
Scan5:  -----  magenta 0.5  1.0

TRAC B
Scan1:  -----  green   0.1  1.0
Scan2:  -----  gray1   0.2  1.0
Scan3:  .....   gray2   0.3  1.0
Scan4:  .-.-.-  gray3   0.4  1.0
Scan5:  -----  gray4   0.5  1.0

LIMIT LINE
Upper:  .....   yellow  0.4  2.5
Lower:  .....   yellow  0.4  2.5

GRID Y
Priority low:  .....   blue    0.4  1.0
Priority medium:  .....  blue    0.4  1.0
Priority high:  .-.-.-  blue    0.4  1.0

GRID X
Priority low:  .....   red     0.4  1.0
Priority medium:  .....  red     0.4  1.0
Priority high:  .....   red     0.4  1.0

#           color      gray
#           r  g  b
BACKGROUND COLOR
Frame:  0.7 0.7 0.7  0.7
Plane:  1.0 1.0 1.0  1.0

```

The expressions printed in bold are keywords required by the UPL for the search of parameters under Style, Color, Gray and Width. The parameters must be in the same line as the keyword and separated by at least one blank. Only the lines required for creating the PostScript format must be available. Faulty or missing entries are recognized when the file is accessed and in this case an error message is output on the UPL screen.

The following can be selected:

Style: 4 line patterns

Color: 17 colours and shades of gray for a colour PostScript copy (Color = ON)

Gray: Any number of gray shades for a monochrome PostScript copy (Color = OFF)

Width: Any number of line widths

## 2.14.4 2 Integrating and Output of PostScript Files

### Integrating PostScript files in word processing and design programs

The EPS files created by the UPL are particularly suitable for integrating PostScript files in word processing and design programs. Most of these programs cannot interpret the contents of an EPS file. As a rule they show a frame with or without diagonal lines, or a light-gray rectangular with the name of the EPS picture is displayed instead of the drawing. However, the EPS file is completely and correctly printed out.

To get an idea of the picture content in word processing or design programs, a coarsely rastered bit map can be inserted in the EPS file. The bit map can be evaluated and displayed by some user programs without interpretation of the EPS file.

For this purpose a bit map has to be inserted into the EPS file generated in the UPL. The picture in the EPS file is in the form of a hexdump. The free-ware program **GSview** mentioned before is particularly suitable in this case.

#### Example:

After the start of **GSview**, the name of the EPS file into which the bit map should be integrated is entered under **File - Open**. Under **Bearbeiten - EPS Vorschau einfügen** (Edit - Insert EPS preview) a selection of graphics formats for creating the bit map is displayed, e.g. **Windows Metafile**. Subsequently the name of the EPS file with bit map is specified.

An EPS file with a bit map thus generated can be integrated in Microsoft Word 6.0, for instance, where the bit map is displayed in the Word document.

#### Example:

After starting the Windows program **Microsoft Word 6.0**, a window is opened with **Einfügen - Grafik** (Insert - Graphics), where the **file type Encapsulated Postscript (\*.EPS)** and the **file name** of the EPS file to be inserted are selected.

The bit map is now displayed in the document. With **File Print...** the PostScript picture (not the bit map) is printed with the highest possible resolution, provided the correct PostScript printer driver is installed (see "Printout of PostScript files").

The Windows graphics program **CorelDRAW 5.0** is able to directly interpret and display an EPS file of the UPL:

#### Example:

**File - Import - Aufzulistender Dateityp** (file type listed) - **PostScript (Interpreted) (\*.eps, \*.ps)**

**Printing PostScript files:**

If a PostScript printer is available, EPS files can be directly printed, e.g. with command "`copy SCREEN.EPS prn:`" in **DOS**. Under **Windows** a printout at this low level is not possible. Here it is advisable to integrate the EPS file as described in a word processing or design program, a graphics program or in GSview with subsequent printout.

For printing EPS files that have been integrated in a word processing or design program, or \*.PS or \*.EPS files loaded with GSview, an appropriate PostScript printer driver should be installed. **It is not sufficient** to just connect a PostScript printer; a suitable PostScript printer driver should also be available.

Without an adequate printer driver being installed, Windows does not know that a PostScript printer is available and only an empty frame or, if a bit map is integrated in the EPS file, a coarsely rastered bit map is printed.

<p><i>To obtain a true PostScript hardcopy, a Postscript printer driver is <b>indispensable</b>, e.g. printer driver "<b>HP LaserJet 4/4M PostScript</b>" for HP laser printer LaserJet 4 Plus. Only in this case the original EPS file will be printed with the highest possible resolution.</i></p>
---

### 2.14.5 Output of Measurement Traces and Lists

The following menu item is available in the OPTIONS panel under the heading PRINT.

The measured values and other block data are output to printer as numbers (in ASCII code) using this key (immediately executed, the H COPY key need not be pressed).

Type	
<b>OFF</b>	The first column contains the data selected in the following. The values which would be on the X-axis with Curve Plot, usually the swept values, are contained in the second column.
<b>TRACE A TRACE B</b>	Function is off.
<b>EQUALIZATN</b>	Prints the measured values selected for TRACE A (or TRACE B) in the DISPLAY panel. Also, units (and reference values, if any) are taken over from the DISPLAY panel.
<b>LIM REPORT</b>	Prints the values of the equalization table.
<b>DWELL VALUE</b>	Prints only values exceeding the limits. Limit check must be activated.
<b>LIM UPPER</b>	Prints the values for the sweep dwell time.
<b>LIM LOWER</b>	Prints the upper limit curve.
<b>X AXIS</b>	Prints the lower limit curve.
<b>Z AXIS</b>	Prints the values of the X-axis only.
<b>TRACE A + B</b>	Prints the values of the Z-axis only.
	Prints both traces next to one another. The X-axis is output in the 3rd column.

## 2.15 Setting and Displaying Auxiliary Parameters (OPTIONS Panel)

Activate the OPTIONS panel by pressing the OPTIONS key (UPL front panel) or key combination ALT-O (external keyboard). The panel is displayed on the right side of the screen.

### 2.15.1 Selecting the Remote-Control Interface (IEC/IEEE Bus/COM2)

Remote via

IEC BUS  
COM2

Defining the interface for UPL remote control.

The selection only affects the talker/listener mode but not the controller mode (e.g. via Automatic Sequence Controller UPL-B10).

Remote control via the built-in IEC/IEEE-bus interface.

Remote control via the serial COM2 interface. Interface parameters are defined further down in the COM2 PARAMETER menu.

**Note:** UPL uses 2 serial interfaces (9-pin).  
COM1 is not used by the instrument software and available for user applications (e.g. mouse).  
COM2 is generally reserved for the instrument software (remote control, plotter control). In the event that it is used for user-specific applications make sure that it is not defined as a remote-control or plotter interface by a device setting, not even for a brief period of time.

UPL IEC adr

Defining the IEC/IEEE-bus address for the UPL to an IEC/IEEE bus.

*Displayed only when "Remote via IEC BUS" has been selected.*

Application: see **2.17 Connecting External Devices**

**Note:** The IEC/IEEE-bus address set or selected on UPL start-up remains unchanged when a setup or a default setup is loaded.

Specified range 0 to 31

Default: 20

Unit : none

COM2 PARAMETER

Defining the parameters for the serial COM2 interface. The parameters set here apply to remote control and hardcopy printout on a plotter on which the COM2 interface is selected. The parameters determined here comply with those of the connected instrument (host computer or plotter).

The following parameters are standard setting for the COM2 interface of the UPL:

9600 baud, even parity, 7 data bits, 1 stop bit.

These standard parameters are set upon UPL switch-on when the BACKSPACE key is pressed (loading the DEFAULT setup), UPL -d is entered at the DOS level or after (re)installation of an UPL software.

The COM2 parameters set upon UPL start-up or selected by the user remain unchanged when a setup or the default setup is loaded. Thus it can be ensured that interface parameters having to comply with those of the connected instrument are not inadvertently overwritten.

**Note:** Interface parameters should not be changed via the COM2 remote control. COM1 parameters can only be changed with the DOS command `MODE` at the operating system level. This can be done:

- by changing the `AUTOEXEC.BAT` file,
- after quitting the UPL with the aid of the `SYSTEM` key,
- after execution of the `SHELL` command in the automatic sequence controller (UPL-B10).

Further information on **baud rate**, **parity**, **data bits** and **stop bits** can be obtained from the UPL online help or the DOS help at the operating system level with command `HELP MODE` under section "Configure Serial Port".

<b>Baud Rate</b>	Transmission rate in baud (bits/s)
2400 Baud 3600 Baud 4800 Baud 7200 Baud 9600 Baud 19200 Baud 38400 Baud 56000 Baud	Default setting: 9600 baud
<b>Parity</b>	Parity check
NONE	Switching off the parity check
EVEN	Check for even parity (default setting)
ODD	Check for <i>odd</i> parity
<b>Data Bits</b>	Number of data bits
7 8	Default setting: 7
<b>Stop Bits</b>	Number of stop bits
1 2	Default setting: 1





### 2.15.2 Beeper On/Off

Beeper

ON

A brief audible warning is output in the case of error messages, when specified ranges or limits are exceeded and at the end of sweeps.

OFF

Beeper switched off.

### 2.15.3 Keyboard Settings

The settings refer to both the UPL front panel and the external keyboard (if available).

Rep rate

(Repetition rate)

Number of generated key codes per second (unit: Hz) with repetitive triggering.

Specified range: 0 (no repetitive triggering) to 50 Hz

Default: 10 Hz

Rep delay

(Repetition delay)

Time delay until repetitive triggering responds (Unit: s).

Specified range: 0.25 to 1.0 s

Default: 0.5 s

### 2.15.4 Language of Help Texts

Language

Selecting the language used for online help. Key functions of the external keyboard remain unchanged but they can be changed for instance via the auxiliary program BOOTSET.BAT.

**Note:** *The selected language is not changed when a setup or default setup is loaded.*

ENGLISH

Help texts are displayed in English

GERMAN

Help texts are displayed in German

The external keyboard functions are assigned with the aid of various AUTOEXEC.BAT files generated through copying with the auxiliary program BOOTSET.BAT.

For UK, AUTOEX\_E.BAT and for GR, AUTOEX\_D.BAT is copied to C:\AUTOEXEC.BAT. These files then call up the configuration file C:\UPL\USERKEYB.BAT where the standard keyboard assignment can be overwritten or further user-defined actions performed.

2.15.5 Display Settings

<b>Extern disp</b>	(External Display)
<b>INTERN ONLY</b>	<p>Display on the built-in LCD screen only.</p> <p><b>Note:</b> With model UPL-66 this menu item is ignored and COLOR set instead. Otherwise there would be a risk of (inadvertently) selecting (eg by loading a setup with this setting) and switching off the external monitor switched off. In this case UPL could only be operated "blind".</p>
<b>BOTH COLOR</b>	<p>Additional display on the external VGA monitor (see 2.17 <b>Connecting External Devices</b>); use a colour monitor for colour output. The display has been optimized for colour display, thus leading to reduced contrast quality on the built-in LCD screen.</p>
<b>BOTH AUTO</b>	<p>Additional display on the external VGA monitor (see 2.17 <b>Connecting External Devices</b>); the display mode (colour or monochrome) is adapted to the built-in LCD screen. Since the display has been optimized for the built-in LCD, the contrast quality is not reduced.</p>
<b>BOTH BW</b>	<p>Additional display on the external VGA monitor (see 2.17 <b>Connecting External Devices</b>), however only monochrome. The contrast quality on the built-in monochrome LCD screen is not reduced in this mode.</p>

2.15.5.1 Switching the Measurement Display ON/OFF

<b>Meas Disp</b>	(Measurement Display)
<b>OFF</b>	<p>Measured value and status displays are switched off. This increases the performance of the measurement routines. Sweeps are up to 15% faster. To be recommended for sweeps and FFTs if maximum performance is required. The status display reads the message</p> <p style="text-align: center;">"MEAS DISPLAY OFF" "Ctrl D to resume"</p>
<b>ON</b>	<p>The measured value displays are switched on, measured value and status display are activated.</p>

**Note:** The MEAS DISP OFF/ON states can be switched via an external keyboard using the key combination Ctrl D.

### 2.15.5.2 Reading Rate of Measurement Results

Read Rate	
MAX SPEED	Maximum output speed of measurement results
6/S	6 measurement results / second
3/S	3 measurement results / second
1/S	1 measurement result / second

**Note:** The setting is only effective in the measurement mode Continuous. With sweeps, start condition timechart and single triggered measurements, the measurement results are always output at maximum speed.

The output speed over the IEC/IEEE bus is not influenced, and is always at a maximum.

### 2.15.5.3 Resolution of Measurement Results

Read Resol	
CHOICE ...	<p>A selection box appears after the SELECT key is pressed, in which the resolution of the measured value in trailing decimal places can be inputted for each measurement result window.</p> <p>0: automatic display of the trailing decimal places</p> <p>1 to 4: 1 to 4 trailing decimal places, whereby the result may be filled out with zeros</p>

### 2.15.5.4 Graphics Display with Selectable Colours

When individual traces, trace groups (see section 2.9.3.3 Scan Count >1) and bars are displayed, a specific colour or shade of gray can be assigned to each trace or bar for easy distinction. Colour or shade of gray depends on the colour or monochrome representation selected under the menu item `Extrn Disp` (see section 2.15.5 Display Settings).

In addition a line pattern and line width can be assigned to sweep traces and trace groups.

Settings for colour/shade of gray, line pattern, line width are made in the OPTIONS panel under

DISPLAY \_\_\_\_\_  
 TRACES COLOR/LINE \_\_\_\_\_

The settings for colour and line pattern for max. 17 scans in channel A and channel B are stored in the self-explanatory text file `C:\UPL\REF\TRCCOL.CFG`.

**In exceptional cases** this file can be edited using an ASCII editor in the DOS operating system, on the condition that positions and length (correct number of trailing blanks) of the text are not changed.

**Note:** If the file has been destroyed by mistake, it can be newly created using commands `Scan conf = DEFAULT` with a default setting.

All scans of TRACE A are green (uninterrupted, narrow line), and all scans of TRACE B yellow (dotted, narrow line).

The colour and line-pattern settings stored in this file are setup-independent and **remain unchanged when a setup or the default setup is loaded.**

**Trace groups:**

For trace group display (see 2.9.3.3 Scan Count >1) a colour/shade of gray and a line pattern can be assigned to max. 17 scans in channel A and channel B (DISPLAY panel: Scan count  $\geq 2$ ).

If more than 17 scans are displayed on the UPL, the 18th scan is assigned the colour and line pattern of the 1st scan, etc.

**Single sweep traces:**

If only one sweep trace is displayed in channel 1 and channel 2

(DISPLAY panel: Scan count = 1), the colour/shade of gray and the line pattern specified under Scannr.A = 1 and Scannr.B = 1 will be assigned. Settings for Scannr.A/B = 2...17 are meaningless.

**Display of FFT, waveform and filter simulation:**

ANALYZER panel:

FUNCTION = FFT | WAVEFORM | FILTER SIM

For displaying the traces in channel 1 and channel 2 for the above-mentioned measurement functions the colour/shade of gray specified under Scannr.A = 1 and Scannr.B = 1 is assigned. Assigning a line pattern is not useful and not performed.

Settings for Scannr.A/B = 2...17 are meaningless.

**Bargraph for DFD, THIRD OCT and MOD DIST measurement:**

ANALYZER panel:

FUNCTION = DFD | THIRD OCT | MOD DIST

For a vertical bar display of channel 1 or channel 2 for these measurement functions, the colour/shade of gray specified under Scannr.A = 1 and Scannr.B = 1 is assigned. Assigning a line pattern is not useful and not performed.

Settings for Scannr.A/B = 2...17 are meaningless.

**Bargraph display:**

The horizontal bars for BarA, BarB and BarX are displayed in the colour/shade of gray specified under Scannr.A = 1. If a limit violation occurs for one the bars (DISPLAY panel: LIMIT CHECK...) the colour/shade of gray changes as specified under Scannr.B = 1. Settings for Scannr.A/B = 2...17 are meaningless.

**PROTOCOL panel:**

Parameters are displayed in the colour/shade of gray specified under Scannr.A = 1, comments are printed as specified under Scannr.B = 1. Variable parameters are always printed in red.

**Result display:**

The six measured values in the result display are represented in the colour/shade of gray specified under Scannr.A = 1, if no display of trace groups has been selected (DISPLAY panel: Scan count  $\geq 2$ ).

## Scan conf

## MANUAL

Colour/shade of gray and line pattern for each scan number entered with commands `Scannr.(A)` and `Scannr.(B)` can be separately changed.

## DEFAULT

Automatic assignment of colour and line pattern to 17 scans of Trace A and Trace B. All scans of Trace A are green (uninterrupted), those of Trace B yellow (dotted), thin lines.

## AUTO COLOR

Automatic assignment of colours to 17 scans of Trace A and Trace B, GREEN, YELLOW, BLUE, CYAN, MAGENTA and WHITE being assigned repeatedly in exactly this order. BLACK, DARK GRAY and LIGHT GRAY are assigned to the monochrome display.

Traces A and B are distinguished by the type of lines used, `————` for trace A and `.....` for trace B.

**Note:** *If WHITE proves to be unfavourable for a scan because the limit lines are (normally) drawn in white, different colours can be assigned to these scans using the following commands.*

## AUTO LINE

Automatic assignment of line patterns to 17 scans of Trace A and Trace B, with the 4 thin line patterns `————`, `-----`, `.....` and `.-.-.-` being assigned repeatedly in this order.

To distinguish the traces, trace A is shown in green and trace B in yellow

Scannr.(A)  
Scannr.(B)

Scan number 1 to 17, to which a colour/shade of gray or a line pattern is to be assigned using commands `Color(A/B)` and `Line(A/B)`.

If the **scan number 0** is entered, all 17 scans are assigned the same colour/shade of gray and the same line pattern, when command

`Color(A/B)`

or

`Line(A/B)`

is entered.

Specified range: 0 to 17

Default: 0

Color (A)  
Color (B)

GREEN  
YELLOW  
BLUE  
CYAN  
MAGENTA  
WHITE  
  
BLACK  
DARK GRAY  
LIGHT GRAY

Assignment of colour/shade of gray to individual scans

**Colour** of scan number specified with command  
Scannr.(A)

or

Scannr.(B),  
if colour display is selected using command Extrn Disp = BOTH COLOR.

**Shades of gray** specified with command  
Scannr.(A)

or

Scannr.(B),  
if monochrome display is selected using command Extrn Disp

**Note:** *If colour/shade of gray is selected while Scannr.(A/B) = 0, all 17 scans will be assigned the same colour. To avoid this being done inadvertently, a query has to be confirmed before the command is executed.*

Line (A)  
Line (B)

\_\_\_\_\_

-----

.....

-.-.-.-

=====

=====  
: : : : :  
: : : : :

Line pattern for scan number specified with

Scannr.(A)

or

Scannr.(B).

Normal line width

Triple line width

**Note:** *If line pattern is selected while Scannr.(A/B) = 0, all 17 scans will be assigned the same pattern. To avoid this being done inadvertently, a query has to be confirmed before the command is executed.*

2.15.6 Calibration

**Calibration ANL**

**Zero Auto**

OFF

ON

ONCE

Dynamic offset calibration

DC offset calibration of the A/D converter or analog board is OFF; the most recently valid calibration factors are used.

**Note:** Calibration should be switched off for short periods only (e.g. for the execution of a sweep), as otherwise large measurement errors may occur.  
If autorange is used for the measurement, "Zero Auto ONCE" should be called up before calibration is switched off to make sure that **all** ranges which may be required are calibrated.

The DC offset of the A/D converter or the analog board are cyclically calibrated for each voltage range. The length of the calibration interval is 10 minutes at operating temperature; the intervals are shorter when the UPL warms up.

**Note:** A cyclic calibration is not performed while a sweep is running; it is delayed until the sweep is terminated or stopped. This does not apply to precision measurements (Dynamic Mode PRECISION) since the measurement accuracy has priority over the sweep speed.

Immediate offset calibration of the A/D converter or analog board for all ranges. Then the setting returns to the previously selected menu item.

**Note:** Only the **currently** selected analyzer instrument is calibrated.

**Calibration GEN**

**Low Dist**

OFF

ONCE

Displayed only when the low-distortion generator is fitted. Permits automatic calibration of low-distortion generator.

Calibration of low-distortion generator inactive.

Automatic calibration of low-distortion generator. Then the setting changes to OFF.  
Allowed only after an operating time of at least one hour.

**Calibration DIG**



**PhaseToRef**

- OFF**
- ONCE**

Displayed only with Jitter option UPL-B22 installed.  
Permits automatic calibration of digital Phase To Ref measurement and generation.

Calibration of digital Phase To Ref measurement inactive.

Automatic calibration of digital Phase To Ref measurement. Then the setting changes to OFF.

## 2.15.7 Version Display and Service Functions

The version numbers of software, analog and digital hardware and of options are displayed in the OPTIONS panel. Released software options are marked by INST (installed). As these menu items cannot be edited, they cannot be selected by the cursor.

### VERSIONS

#### SOFTWARE -----

Software	<version number>
Setup	<version number>
CPU board	<processor type>
Anlg board	<version number>
Dig. board	<version number>

#### OPTIONS -----

B1 Low Dist	< version number >
B4 Rem Ctrl	INST/-NA-
B2 DigAudio	<version number>
B29 Dig96	<version number>
U8 GSM DAI	<version number>
B5 Speaker	<version number>
B21 DA Prot	INST/-NA-
B22 DA Jitt	INST/-NA-
B23 Coded	INST/-NA-
B10 SeqCtrl	INST/-NA-
B6 Coher	INST/-NA-
B33 ITU O33	INST/-NA-
B8 PhoneTst	INST/-NA-
B9 3G Tests	INST/-NA-

Any software, hardware or option which is not installed is marked by the letters -NA- (Not Available). Otherwise the version number is displayed for an installed hardware option or INST (installed) for a released software option.

Software options are released by entering the instrument-specific installation key under the menu item "InstallKey"; the installation key comes with a detailed description.

The service functions are also contained in the OPTIONS panel. They are given under menu item DIAGNOSTIC, protected by a password and not accessible to the user.

Only one of hardware options B2, B29 and U8 can be installed.

### 2.15.8 Transfer of Parameters (Parameter Link Function)

**Param. Link**

**CHOICE...**

"Parameter Link" offers the possibility of transferring generator and analyzer settings to another signal or test function or to another instrument. The corresponding selection box is opened by pressing the SELECT key. The selected options are marked by a tick, see next page.

If a setting is made in UPL that enables the transfer of parameters in accordance with the options selected (marked with a tick), the user is prompted to confirm the transfer:

Really Parameter Link?

Yes

No

If YES is entered, the parameter setting is transferred to the new signal function when the signal function is changed. For the transfer, a corresponding command line must exist and the setting to be transferred must be selectable for the old and the new function.

Example:  
 Parameter Link with switchover from  
 RMS measurement function to DC measurement function

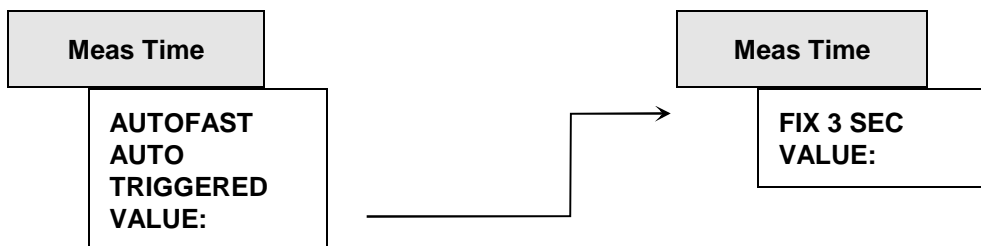

When switching from RMS to DC measurement mode, the setting VALUE: can be transferred. Transfer of the settings AUTO FAST, AUTO and TRIGGERED is not possible as these are not available for the DC measurement function.

Numerical values are transferred only if a corresponding command line exists and if the unit for a value in question is available for the new function or instrument. Transferring values from an analog to a digital instrument and vice versa is therefore not possible, nor is it useful. If the range of values of the new function or instrument is limited so that it does not allow transfer of the value despite appropriate unit, the value to be transferred is set to the upper or lower limit value of this range.

**Explanation of menu items of parameter link box****Changing Gen Function keeps****FUNCTION parameters**

When the signal function is changed, the settings of the old function are transferred to the new function.

**Changing Gen Instrument keeps****Output Config.**

When an instrument is changed, the configuration settings (those relating to the generator outputs) are transferred to the new instrument. No settings will be transferred for changeovers made between analog and digital instruments.

**Changing Gen Instrument keeps****FUNCTION + Parameters**

When an instrument is changed, the signal function and associated settings are transferred to the new instrument provided the signal function and settings are permissible for the new instrument.

**Changing Anl Instrument keeps****FUNCTION parameters**

When the measurement function is changed, the settings of the old function are transferred to the new function.

**Changing Anl Instrument keeps****Input Config.**

When an instrument is changed, the configuration settings (settings relating to the analyzer inputs) are transferred to the new instrument. No settings will be transferred for changeovers made between analog and digital instruments.

**Changing Anl Instrument keeps****START COND**

When an instrument is changed, the START COND settings are transferred to the new instrument.

**Changing Anl Instrument keeps****INPUT DISP**

When an instrument is changed, the INPUT DISP settings are transferred to the new instrument.

**Changing Anl Instrument keeps****FREQ/PHASE**

When an instrument is changed, the FREQ/PHASE settings are transferred to the new instrument provided that the function can be applied in the new instrument.

**Changing Anl Instrument keeps****FUNCTION + Parameters**

When an instrument is changed, the measurement functions and associated settings are transferred to the new instrument provided the measurement function and settings are permissible for the new instrument.

**Function tracking Gen → Anl****MDIST, DFD, POL, FM → W&F**

When the signal function of the generator is changed, the appropriate measurement function for the analyzer is set.

If any signal functions, measurement functions or configuration settings cannot be transferred, a warning will be output.

## 2.15.9 Selecting the Sampling Mode

With option UPL-B29 (digital audio 96 kHz) only

If the new hardware option UPL-B29 is used, UPL can be operated in two different sampling modes to be selected under DIGITAL AUDIO I/O in the OPTIONS panel or via hotkeys on the external keyboard. The selection of the sampling mode influences the generator as well as the analyzer and is therefore all performed in the OPTIONS panel.

Sample Mode	Sampling mode
<p><b>BASE RATE</b></p>	<p>In the base rate mode (BRM), option UPL-B29 performs basically as UPL-B2.            Clock frequencies up to 55 kHz can be generated and analyzed.            Maximum performance of UPL without reduction of functions.</p> <p>Hotkey (external keyboard):    ALT B</p>
<p><b>HIGH RATE</b></p>	<p>In the high rate mode (HRM), UPL can generate and analyze clock frequencies up to 106 kHz. Some measurement functions in two-channel operation are performed at lower speed. Analyzer functions are slightly reduced:</p> <ul style="list-style-type: none"> <li>• no RUB&amp;BUZZ measurement</li> <li>• THIRD OCT measurement only analog</li> <li>• THIRD OCT, WAVEFORM, PEAK and QPEAK measurements only without filter</li> <li>• digital phase measurement not possible with all measurement functions</li> </ul> <p>Hotkey (external keyboard):    ALT H</p>

**Note:** *In the HRM, the performance and the number of analog measurements are also reduced. This mode should therefore only be selected if the higher sampling rate is required for the generator or analyzer.*

## 2.16 Macro-Operation

With the UPL, setting and measurement sequences can be written as BASIC programs or else recorded via the built-in program generator (see 3.16.4.3 Logging Mode - UPL-B10). Option UPL-B10 (Automatic Sequence Control) is required to do this. The generated BASIC programs can be stored (preferred file extension: .BAS) and called and used in various ways:

### 1. Call from BASIC user interface:

Once the BASIC user interface has been activated by pressing F3 (on the external keyboard) or BACKSP (on the UPL keyboard), the program can be loaded with LOAD (softkey or F11) and then started with RUN (softkey or F6). The program name needs to be typed during loading. After the program has been quit, the UPL user interface is reactivated with F3 or the LOCAL key.

### 2. Automatic start of a BASIC program on switch-on:

The UPL can be configured to load and execute (once) a particular program at switch-on. After the program has been quit, the UPL user interface is reactivated with F3 or the LOCAL key. The BASIC program can be either of the following:

- the program INIT.BAS under C:\UPL\USER\, if the power-up mode has been set to 2 with the aid of utility programs BASSET or UPLSET.
- any program whose name is entered with "-bn<filename>" as a call parameter when UPL is started.

### 3. Call from UPL user interface:

Via the menu item "Exec Macro" on the OPTIONS panel, a BASIC file name can be selected with the aid of the standard file box. In the file box, all files with the extension .BAS are listed as standard. The selected BASIC program is loaded and started automatically. After the program has been quit, the UPL user interface is automatically reactivated.

Advantages of this method:

- All BAS files (macros) available in the selected directory are displayed in the file box.
- Faster and more convenient file handling: the file can be selected directly from the UPL file box and does not need to be typed (possibly plus path) after activating the BASIC user interface.
- As no file name needs to be typed, a macro of this type can also be started without an external keyboard (which is required for typing text into a BASIC user interface).

### 4. Call from an external control program via IEC/IEEE-bus interface:

Any BASIC program can be loaded and started with the IEC/IEEE-bus command SYST:PROG:EXEC. After the program has been quit, a 1->0 transition is generated in the RUN bit (#14) of the operation register. This is communicated to the controller via SRQ or serial poll so that it can fetch the measurement results. Data exchange between the external control program and the BASIC program can be performed via the measurement-result displays and the measurement-result buffers.

Advantages of this method:

- Modular measurement tasks; the controller is not directly involved with *how* the measurement is executed in UPL.
- Reduction of controller workload; once the macro has been started, the controller can handle other tasks.
- The measurement algorithms implemented in the BASIC programs of UPL-B10 also be called with a single keystroke in manual mode (see above).

**Exec Macro**

The file bearing the name shown here is loaded and executed as a BASIC file. It is essential this file was generated with the Rohde&Schwarz BASIC, eg in the autocontrol option of either UPD or UPL (UPD-K1 or UPL-B10).

Recommended file extension: .BAS

If the file cannot be opened or if it contains invalid BASIC lines, a BASIC error message is issued.

For infor about entering file names, see 2.3.2.5



## 2.17 Connecting External Devices

**Important:**

*It is recommended to use shielded cables for connection of external devices!*

*Otherwise spurious emissions may slightly increase, adversely affecting a very sensitive device under test.*

All connectors below are located on the UPL rear panel (see 2.1.2 Rear-panel View).

### IEC/IEEE bus

Option: UPL-B4 (IEC-625/IEEE-488 interface)

Applications:

- Remote control of UPL from a host computer; select the address in the OPTIONS panel: "UPL IECadr" (see 2.15.1 IEC/IEEE-bus Address).
- SCREEN HARD COPY on a plotter connected to the IEC/IEEE bus; settings in the OPTIONS panel: "Destin → PLOTTER", "Plot on → IEC BUS", "IEC-Adr" (see 2.14 Printing / Plotting / Storing the Screen Contents (OPTIONS Panel)).

For IEC/IEEE-bus operation, see 3 Remote Control

### RS-232 (COM1, COM2)

2 serial interfaces

The serial interfaces COM1 and COM2 have the following standard configuration:

- transmission rate 9600 baud
- even parity,
- 7 data bits,
- 1 stop bit,
- none retry.

Use of COM1 (free for user-defined instruments):

- Connection of mouse or rollkey; permits alternative operation of panels and softkeys (see 1.1.7 Connecting a Mouse, 2.3 General Instructions for Use).

Use of COM2 (reserved for instrument software):

- Remote control of UPL from a host computer. For remote-control operation see **3 Remote Control**.
- SCREEN HARD COPY on a plotter connected to COM2; settings in the OPTIONS panel: "Destin → PLOTTER", "Plot on → COM2" (see 2.14.1 Screen copy to printer (pixel-oriented)).

The interfaces can be reconfigured

- at operating system level using the DOS command MODE (changing to DOS with the SYSTEM key),
- automatically on power up of the UPL by making an appropriate entry into the AUTOEXEC.BAT file,
- when using the Universal Sequence Controller UPL-B10.

## SYNTAX

```
mode comm [:] [b[,b[,d[,s[,r]]]]]
```

```
mode comm [:] [baud=b] [parity=p] [data=d] [stop=s] [retry=r]
```

## Parameter

**comm**

Denotes the number of the pin for asynchronous data transmissions (COM). Valid values for *m* are 1 or 2.

If one of the following five parameters is omitted, **mode** uses the last setting of the omitted parameter. If the short form of the syntax is used (without the words **baud =**, **parity =**, **data** etc.), the **mode** command identifies the parameters by their position. If no value is entered for a particular parameter, the comma preceding the next parameter must be entered.

**baud=*b***

Denotes the first two positions of the transmission rate in bits per second. The following list contains the valid values for *b* and the corresponding transmission rates:

11	110 baud
15	150 baud
30	300 baud
60	600 baud
12	1200 baud
24	2400 baud
48	4800 baud
96	9600 baud

This parameter can be abbreviated by omitting **baud =** and entering a value for *b*.

**parity =*p***

Determines how the parity bit is used by the system to check transmission errors. *p* may assume one of the following values: **n** (none), **e** (even) or **o** (odd). The standard value is **e**. This parameter can be abbreviated by simply omitting **parity =** and specifying a value *p*.

**data =*d***

Denotes the number of data bits per character: Valid values for *d* are 7 or 8. The standard value is 7 data bits. This parameter can be abbreviated by simply omitting **data =** and specifying a value for *d*.

**stop =*s***

Denotes the number of stop bits defining the end of a character: 1 or 2. If the transmission rate 110 has been set, 2 stop bits are used as standard. Otherwise, the standard value is 1. This parameter can be abbreviated by simply omitting **stop =** and entering a value for *s*.

**retry = r**

Determines what is to happen in the case of a time exceeded error if **mode** attempts to send an output to a serial printer. The option causes a part of **mode** to remain resident in the working memory. The following list contains the valid values for *r* and a short description of their meaning.

- e Output an error following a status check of a busy pin
- b Indicate "busy" following a status check of a busy pin
- p Try until the interface accepts the output.
- r Indicate "ready" following a status check of a busy pin
- n Do not try again (standard). **none** can also be indicated for this value.

This parameter can be abbreviated by omitting **retry =** and specifying a value for *r*.

Serial interface:

Typical connections to external device with 9-pin connector (PC) using the acknowledge signal lines.

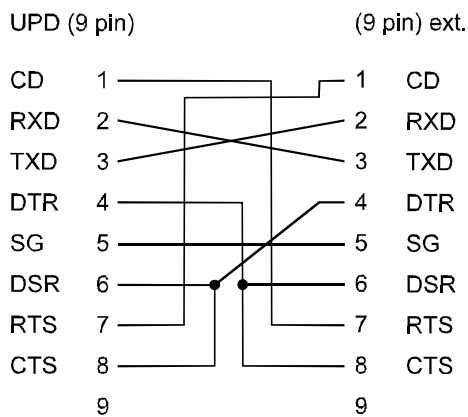

Fig. 2-44 9-pin serial interface

Typical connections to external device with 25-pin serial connector using the acknowledge signal lines.

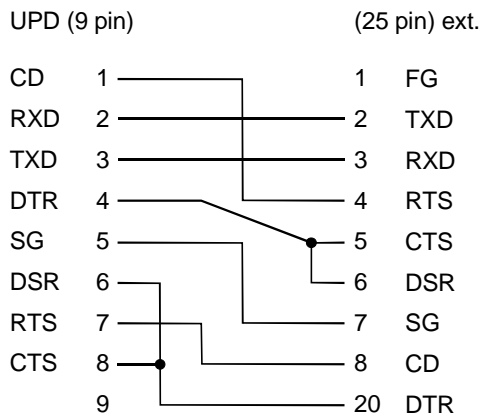

Fig. 2-45 25-pin serial interface

25-pin serial interface without acknowledge signal lines

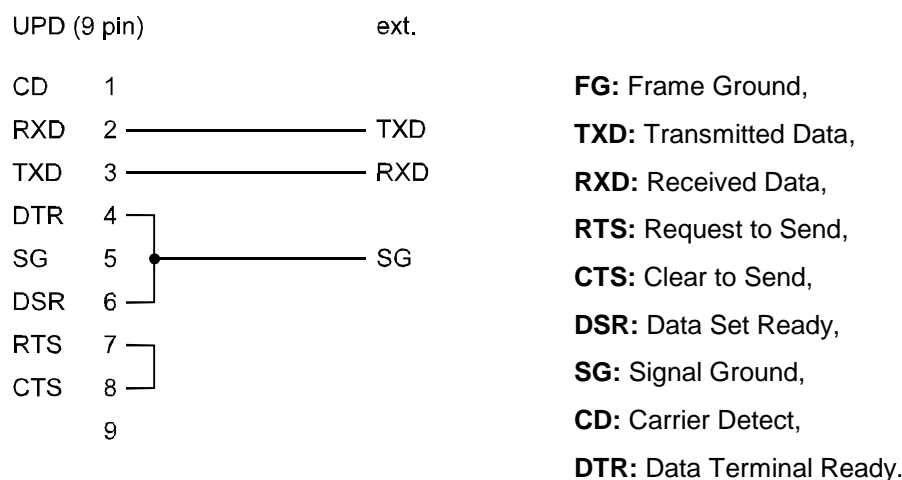

Fig. 2-46 25-pin serial interface without acknowledge signal lines

**Note:** The connection cable between UPL (9-pin connector) and the external device (e.g. plotter) should be configured as described in the instrument manual (of the plotter, for instance). The UPL side can be connected up as in the case of connection of an ISA (IBM-PC)-compatible computer.

## Centronics

Parallel interface for connection of a printer (see 2.14.5 Output of Measurement Traces and Lists)

## VGA (external VGA monitor)

CRT interface for connection of a (colour or monochrome) VGA monitor

Advantages:

- Larger screen size
- Colour trace representation possible even for an UPL with monochrome screen

Switchover to the external monitor in the OPTIONS panel using the menu item "Extrn disp → BOTH..." (see 2.15.5 Display Settings)

**Note:** When connecting an external monochrome VGA monitor, the file C:CONFIG.SYS must be changed (for more detailed explanation see comment in this file).

## 2.18 UPL Used as Computer

The UPL software is created on the basis of the MS-DOS<sup>®</sup> operating system from Microsoft. MS-DOS commands and programs are available when exiting the UPL software.

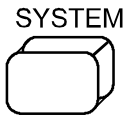

This key (or key combination CTRL-F9 on the external keyboard) is used to exit the UPL software. A dialog box is then displayed in which the command must be confirmed in order to avoid the inadvertent exit to the MS-DOS<sup>®</sup> operating system.

**Note:** *The key combinations CTRL-C or CTRL-PAUSE (via external keyboard only) have the same function as the SYSTEM key. Pressing these keys inadvertently therefore does not cause a program interruption.*

At the operating system level, the user is responsible for not changing or deleting the files required by the UPL. Also, the directory structure used should be maintained (see 1.2.1 Enabling Software Options). The CONFIG.SYS and AUTOEXEC.BAT files required for starting the UPL should be modified by experienced users only.

The following three ways are possible for restarting the UPL software:

1. Call the UPL.BAT batch file by way of >UPL (where ">" is the input request by MS-DOS<sup>®</sup> and need not be entered).
2. Press the CTRL, ALT and DEL keys simultaneously in order to trigger a warm start.
3. Switch the UPL off and (after a few seconds) on again.

Due to the License Agreement with Microsoft, office applications are not allowed to be installed on the system.

### 2.18.1 Setting the Realtime Clock

If the display of time or date is no longer correct in the UPL, the PC realtime clock must be set. This is effected at the operating system level using the DOS commands TIME and DATE. Exit from the current mode and access to the operating system is made using the SYSTEM key (cf.).

## A

A weighting.....	2.208	ANALYZER panel .....	2.142
A WITH * .....	2.343	Analyzers	
A WITH o.....	2.343	reference values .....	2.172
Abort.....	2.364	ANLG - ANLG .....	2.297
Abort event.....	2.358, 2.363	ANLG – DIGI.....	2.297
AC coupling.....	2.147	ANLG 25 kHz.....	2.65
AC coupling input unit.....	2.151	ANLR key.....	2.3, 2.278
AC supply network.....	1.1	ANLR SYNC.....	2.94
AC supply voltages.....	1.1	ANLR TRACK .....	2.101
AC-3 .....	2.135	ANLR-TRACK .....	2.118
AC-3 format.....	2.135	Application .....	2.297
Activating		application setups .....	2.297
STATUS panel .....	2.293	ARBITRARY .....	2.85
Activation panels .....	2.31	ARBITRARY signals	
ACTUAL .....	2.298, 2.299	measuring on .....	2.181
Actual instrument setup .....	2.298, 2.299	Arbitrary waveform .....	2.85
Actual setup.....	2.298, 2.299	Arith. symm. bandwidth RMS sel.....	2.186
Actual setup and data.....	2.299	Arithmetic averaging, settling .....	2.42, 2.175
ACTUAL+DATA.....	2.299	ASCII .....	2.305, 2.354
Address		ASCII format .....	2.305
IEC/IEEE bus .....	3.4	Asterisk .....	3.15
Addressed commands .....	3.295	Asymmetrical sine burst .....	2.85
AES Ch1.....	2.262	AT o DOWN .....	2.340
AES Ch1&2 .....	2.262	AT o UP .....	2.340
AES Ch2.....	2.262	Atten .....	2.285
AES/EBU protocol definition .....	2.78	Attenuation.....	2.284
AES/EBU receivers		Attrib .....	2.300
reset.....	2.365	Attribute.....	2.300
ALL.....	2.348	AUD IN RCLK .....	2.74
All di .....	2.200	Audio Bits.....	2.75, 2.157
All even di.....	2.200	AUDIO DATA .....	2.71, 2.153
All odd di.....	2.200	AUDIO IN.....	2.71, 2.72, 2.74, 2.156
ALL ONE .....	2.74	AUDIO OUT.....	2.71, 2.74
ALL ZERO .....	2.74	AUTO ..2.157, 2.159, 2.174, 2.179, 2.185, 2.202, 2.207, 2.248	
AM.....	2.132	AUTO COLOR .....	2.397
Ampl Var.....	2.89, 2.105, 2.122, 2.126	AUTO FAST.....	2.179, 2.185, 2.248
Amplitude		AUTO LINE .....	2.397
distribution.....	2.86	AUTO LIST	
ratio (MOD DIST)		Generator-Sweep.....	2.93
generator.....	2.111	AUTO ONCE.....	2.335, 2.348
Amplitude accuracy .....	2.226	AUTO Range	
Amplitude entry		Analyzer.....	2.149
FM.....	2.132	generator .....	2.67
Amplitude list (list sweep) .....	2.141	AUTO SCALE .....	2.335, 2.338, 2.348
Amplitude modulation .....	2.132	AUTO SCALE .....	2.335
Amplitude ratio (MOD DIST)		AUTO SWEEP	
analyzer.....	2.212	analyzer .....	2.187
Amplitude Variation.....	2.89	Generator.....	2.93
Analog		Automatic	
analyzer.....	2.146	sweep .....	2.187
Analog Ampl .....	2.139	sweep .....	2.93
Analog Freq.....	2.139	Automatic control, size of data memory.....	3.356
Analog generator .....	2.66	Automatic range selection .....	2.149
Analog interfaces		AUX GEN.....	2.138
Input connectors.....	2.9	Availability	
Analog notch filter.....	2.201, 2.205, 2.213	phase measurement .....	2.240
ANALOG OUT.....	2.138	sweep parameters.....	2.91
Analyzer		AVERAGE.....	2.175
availability of functions .....	2.144	AVERAGE, settling .....	2.42
configuration.....	2.146	Averaging	
Filters .....	2.278	FFT.....	2.223
input peak measurement .....	2.144	measurement results.....	2.42
input peak measurements .....	2.235	Averaging method in the FFT.....	2.223
instruments.....	2.142	Avg Count.....	2.223, 2.245
measurement functions .....	2.165	Avg Mode.....	2.223
measurement range limits .....	2.143		
reference value.....	2.169, 2.172		
Settings .....	2.16		
synchronization.....	2.94		
ways of starting .....	2.159		

## B

B WITH \* ..... 2.343  
 B WITH o ..... 2.343  
 BACK softkey ..... 2.337  
 BACKSP ..... 2.5  
 BAL  
   Generator ..... 2.139  
 BAL XLR  
   analyzer ..... 2.148, 2.154  
   Generator ..... 2.66, 2.139  
 Balanced Output ..... 2.69  
 Band limit  
   THD+N / SINAD ..... 2.208  
 Band limits  
   analyzer instruments ..... 2.143  
 BAND PASS ..... 2.287  
 BAND STOP ..... 2.287  
 Bandpass ..... 2.184  
   center frequency ..... 2.194  
   RMS sel ..... 2.184  
 Bandpass ..... 2.287  
 Bandstop ..... 2.287  
 bandwidth  
   third octave ..... 2.252  
   twelfth octave ..... 2.256  
 Bandwidth  
   analyzer ..... 2.186  
   RMS Select ..... 2.186  
 Bandwidth bandpass RMS sel ..... 2.186  
 BAR 1 ..... 2.348  
 BAR 2 ..... 2.348  
 BAR 3 ..... 2.348  
 Bar chart  
   MOD DIST ..... 2.213  
 BARGRAPH ..... 2.327  
 BARGRAPH display ..... 2.347, 2.349  
 BARGRAPH display parameters ..... 2.347  
 BARGRAPH X ..... 2.347  
 BARGRAPH1 ..... 2.347  
 BARGRAPH2 ..... 2.347  
 BASIC-Macro ..... 3.329  
 Battery replacement ..... 4.8  
 baud ..... 2.409  
 Baud Rate ..... 2.391  
 Beats  
   DC measurement ..... 2.198  
   RMS measurement ..... 2.181  
 Beeper ..... 2.393  
 Beeper On/Off ..... 2.393  
 BIN ENTRY ..... 2.79, 2.81  
 BINARY ..... 2.354  
 Binary block data ..... 3.364  
 Binary data blocks ..... 3.12  
 Binary form ..... 2.305  
 BIOS-SETUP ..... 4.2  
 BIPHASE CLK ..... 2.74  
 Biquads ..... 2.229  
 BLACKMAN-HARRIS ..... 2.222, 2.245  
 BLOCK ..... 2.182, 2.193, 2.250  
 Boards replacement ..... 4.7  
 Boolean parameter (command) ..... 3.13  
 BOTH ..... 2.153  
 BOTH AUTO ..... 2.394  
 BOTH BW ..... 2.394  
 BOTH COLOR ..... 2.394  
 Bottom ..... 2.335  
 Bounding Box ..... 2.378  
 BP 1% ..... 2.186  
 BP 1/12 OCT ..... 2.186  
 BP 1/3 OCT ..... 2.186  
 BP 3% ..... 2.186

BP FAST ..... 2.186  
 BP FIX: ..... 2.186  
 Broadband noise ..... 2.199  
 BS 1% ..... 2.186  
 BS 1/12 OCT ..... 2.186  
 BS 1/3 OCT ..... 2.186  
 BS 3% ..... 2.186  
 BS FAST ..... 2.186  
 BS FIX: ..... 2.186  
 BURST ..... 2.89, 2.105, 2.122, 2.126  
   burst duration ..... 2.90, 2.105, 2.123, 2.126  
   Burst duration SINE BURST ..... 2.108  
   Burst on Del ..... 2.108, 2.110  
   Burst signal SINE ..... 2.106

## C

C 448 kb/s ..... 2.135  
 C MESSAGE ..... 2.208  
 Cable Sim ..... 2.72  
 Cable Simulation ..... 2.72  
 Calculation of filters ..... 2.285, 2.291  
 Calibration ..... 2.399  
   DIG ..... 2.399  
 Calibration ANL ..... 2.399  
 Calibration GEN ..... 2.399  
 Calibration of low-distortion generator ..... 2.399  
 CANCEL ..... 2.5, 2.13, 2.34, 2.35  
 CANCEL .....  
 Carr Freq ..... 2.132  
 Carr Volt ..... 2.132  
 Carrier frequency  
   FM ..... 2.132  
 CCIR 409-J standard W&F ..... 2.217  
 CCIR unwt'd ..... 2.208  
 CCIR wtd ..... 2.208  
 CCIT ARM ..... 2.208  
 CCITT 0.41 ..... 2.208  
 CEN TO o ..... 2.340  
 Center ..... 2.224  
 Center Freq ..... 2.289, 2.290  
 Center frequency  
   bandpass RMS sel ..... 2.194  
   DFD ..... 2.115  
   notch filter ..... 2.174  
 Center frequency ..... 2.290  
 Centronics ..... 2.411  
 Ch Stat. L ..... 2.79  
 Ch. Stat. R ..... 2.81  
 Chan delay ..... 2.220, 2.245  
 Chan Mode ..... 2.135  
 CHAN STAT L ..... 2.353  
 CHAN STAT R ..... 2.353  
 CHAN STATUS ..... 2.157  
 Changing  
   an instrument ..... 2.33  
   functions ..... 2.34  
   the panels ..... 2.29, 2.30, 2.31  
 Changing a function  
   parameter link ..... 2.34  
 Changing an instrument  
   parameter link ..... 2.33  
 Changing between the instruments ..... 2.34  
 Changing the unit at a later date ..... 2.35

- Channel
  - sequence..... 2.352
- Channel delay..... 2.220
- Channel Mode..... 2.135
- Channel status..... 2.84
- Channel status data, user data, validity, parity..... 2.78
- Channel(s)
  - analyzer..... 2.146, 2.153
  - generator..... 2.66
  - Generator..... 2.139
- Character
  - data (command)..... 3.13
  - string (command)..... 3.14
- Characteristic notch..... 2.174
- Check..... 2.350
- CHECKSUM ERROR..... 4.5
- CHOICE..... 2.403
- Clock rate generator..... 2.73
- Clock rate error..... 2.352
- CMOS CHECKSUM ERROR..... 4.5
- Coded Audio..... 2.134
- CODED AUDIO..... 2.85
- Coded Audio Signal Generation..... 2.134
- COHERENCE..... 2.165
- Coherence Measurement..... 2.244
- Colon..... 3.15
- Color..... 2.27, 2.398
- Color palette information..... 2.294
- Colour..... 2.377
- Colour display..... 2.394
- Colour display PROTOCOL analysis..... 2.352
- Colour monitor..... 2.394
- Colour monitor..... 2.394
- COM2..... 2.379, 2.390
- COM2 interface..... 2.390
- COM2 PARAMETER..... 2.390
- Comma..... 3.15
- Command
  - addressed..... 3.295
  - Common..... 3.295
  - common commands..... 3.39
  - header..... 3.7
  - hierarchy..... 3.7
  - keyword..... 3.7
  - line
    - delimiter..... 3.9
    - structure..... 3.9
    - numeric suffix..... 3.8
    - parameters..... 3.13
    - permissibility..... 3.19
    - processing..... 3.18
    - structure..... 3.7
    - synchronization..... 3.21
    - syntax elements..... 3.15
- command line option
  - tappl..... 2.296
- command line parameter
  - tthdnwin..... 2.210
- COMMENT..... 2.336
- Comments for hardcopy..... 2.299
- Comments on hardcopy..... 2.298
- Common
  - analyzer..... 2.148
- Common Ampl..... 2.140
- Common commands..... 3.39, 3.295
- form..... 3.7
- Common Freq..... 2.140
- COMMON MODE..... 2.138
- COMMON ONLY..... 2.71
- Common parameters
  - all analyzer functions..... 2.166
  - all filters..... 2.285
  - all generator functions..... 2.87
  - generator signals..... 2.86
  - SINE, DFD, MOD DIST signals..... 2.86
- COMMON/INP..... 2.153
- Comp..... 2.231
- COMPLETE..... 2.298, 2.299
- Complete setup..... 2.298, 2.299
- COMPRESS..... 2.135
- COMPRESSED..... 2.231
- Computer operation of UPL..... 2.412
- CONDition register..... 3.25
- Conditional tracing of measured values..... 2.159
- Configuration
  - analog analyzer..... 2.146
  - analog generator..... 2.66, 2.139, 2.140, 2.141
  - digital analyzers..... 2.153
  - digital generator..... 2.71
- Configuration File PS.CFG..... 2.385
- Connecting
  - external devices..... 2.408
  - external VGA monitor..... 2.11
- CONT..... 2.358
- CONT key..... 2.161
- Continuous measurement..... 2.360
- Continuous measurement without trigger condition..... 2.159
- Contrast..... 1.3
- Control file..... 2.321
- Control panel
  - CONTROL..... 2.5, 2.7
  - CURSOR / VARIATION..... 2.7
  - EDIT..... 2.5
  - Front-panel..... 2.3
- conversion factor..... 2.170
- Conversion factor..... 2.269
- Conversion formula of units..... 2.57
- Copy..... 2.373
- COPY..... 2.27
- coupling
  - AC..... 2.178
  - DC..... 2.178
- Coupling
  - analyzer inputs..... 2.147
- Crest Fact..... 2.102, 2.120
- Crosstalk..... 2.266
- CRT monitor..... 2.411
- Ctrl D..... 2.394
- Cursor
  - graphics..... 2.337, 2.343
  - panel..... 2.31
- Cursor IMAX A..... 2.343
- Cursor IMAX B..... 2.343
- CURVE..... 2.338, 2.373
- Curve plot
  - cursor..... 2.337
  - overrange..... 2.337
  - underrange..... 2.337
- CURVE PLOT..... 2.327
- CURVE/GRID..... 2.373



## D

d2 (IEC 118) ..... 2.215  
d2 (IEC 268) ..... 2.215  
d3 (IEC 118) ..... 2.215  
d3 (IEC 268) ..... 2.215  
Dangerous contact voltages ..... 2.1  
data ..... 2.409  
Data Bits ..... 2.391  
Data entry ..... 2.34  
Data input or output during measurements ..... 2.39  
Data strings (command) ..... 3.14  
DC ..... 2.85, 2.165  
    component ..... 2.87  
    coupling ..... 2.143  
    measurement ..... 2.165, 2.198  
    noise HP ..... 2.208  
    offset ..... 2.87  
    offset calibration ..... 2.399  
    voltage ..... 2.198  
DC coupling ..... 2.147  
DC coupling input unit ..... 2.151  
DC Offset ..... 2.99, 2.101, 2.106, 2.109, 2.111  
    2.114, 2.117, 2.125, 2.127, 2.128  
DC Suppres ..... 2.166, 2.178, 2.184, 2.220  
Decimal point ..... 3.15  
DEEM 50/15 ..... 2.208  
Deemph 50 ..... 2.208  
Deemph 75 ..... 2.208  
Deemph J.17 ..... 2.208  
DEFAULT ..... 2.298, 2.397  
Default setup ..... 2.298  
DEFAULT.SET ..... 2.296  
DEFINE PHASE ..... 2.102  
DEFINE VOLT ..... 2.102  
DEL BEF WR ..... 2.328, 2.330  
Delay  
    filter ..... 2.285  
    restart of measurement ..... 2.162  
Delay value with external sweep ..... 2.50  
Delete ..... 2.321  
DELeTe BEFore WRite ..... 2.330  
Delimiter  
    command line ..... 3.9  
    response to query ..... 3.11  
Destin ..... 2.371, 2.372  
Deviation ..... 2.132  
    FM ..... 2.132  
Deviation settling ..... 2.176  
DFD  
    analyzer ..... 2.165  
    Generator ..... 2.85  
Dialog window  
    multisine ..... 2.103  
DIFF FREQ ..... 2.115  
Difference frequency distortion ..... 2.114, 2.214  
    measurement ..... 2.165, 2.214  
Difference value curves ..... 2.339  
Differences to IEC/IEEE-Bus Remote Control (B10) ..... 3.341  
Differences to remote control via IEC/IEEE bus (RS-232)  
    ..... 3.364  
DIG INP AMP ..... 2.166, 2.235  
DIG OUT AMP ..... 2.170  
DIGI – ANLG ..... 2.297  
DIGI – DIGI ..... 2.297  
DIGITAL ..... 2.65  
Digital generator ..... 2.71  
DIN 45403 ..... 2.114  
DIN 45507 standard W&F ..... 2.217  
DIN/IEC ..... 2.217  
DIN-IEC 268-3 ..... 2.114

Directories ..... 2.37  
Directory structure ..... 1.9  
Display ..... 2.7, 2.327  
DISPLAY key ..... 2.3  
Display modes  
    Switchover using the mouse ..... 2.29  
Display of lists ..... 2.344  
Display of lists parameters ..... 2.344  
Display of traces and spectra ..... 2.330, 2.337  
Distant interferences suppression ..... 2.222  
Distortion measurement ..... 2.165  
Distortion measurement THD+N/SINAD ..... 2.203  
Distortion measurements THD ..... 2.199  
Distribution  
    function ..... 2.86  
    noise ..... 2.122  
Dither ..... 2.85, 2.86, 2.99, 2.101, 2.111, 2.114, 2.128  
Dolby Digital ..... 2.135  
Domain ..... 2.117  
DOS operating system ..... 2.53  
Double cross ..... 3.15  
Drive ..... 2.38  
drivename ..... 2.373  
DUAL FILE ..... 2.302, 2.330, 2.331, 2.344  
Dual trac ..... 2.302  
Dwell ..... 2.94, 2.389  
    file ..... 2.94  
    time ..... 2.94  
    value ..... 2.94  
DWELL FILE ..... 2.94  
Dwell time ..... 2.304  
Dwell time printout ..... 2.389  
DWELL VALUE ..... 2.94, 2.304  
Dyn Mode ..... 2.201, 2.205, 2.206, 2.213, 2.215  
Dynamic  
    offset calibration ..... 2.399  
Dynamic ..... 2.201, 2.205, 2.215  
Dynamic Mode ..... 2.213  
Dynamic Mode PRECISION ..... 2.399

## E

EDG TRG CH1 ..... 2.161  
EDG TRG CH2 ..... 2.161  
Editing files and directories ..... 2.321  
EMC problems ..... 2.154  
ENABLE register ..... 3.26  
ENHANCED ..... 2.78  
ENTER ..... 2.5, 2.13, 2.16, 2.34, 2.35  
Entering a new file name ..... 2.37  
Entering file names ..... 2.36, 2.37  
Entry of amplitude  
    RANDOM (noise) ..... 2.125  
    SINE ..... 2.141  
Entry of data ..... 2.34  
Entry of figures ..... 2.31  
Entry of values  
    brief introduction ..... 2.14  
Epilog for HPGL ..... 2.294  
EQUAL A ..... 2.332  
EQUAL L ..... 2.81  
EQUAL VOLT ..... 2.102  
Equal. file ..... 2.88, 2.99, 2.102, 2.106, 2.114, 2.120  
    ..... 2.130, 2.211, 2.225  
Equalization ..... 2.304  
Equalization ..... 2.389  
Equalization data ..... 2.302

- Equalization file ..... 2.304  
 equalization of analyzer signal ..... 2.210, 2.225  
 equalization of generator signals ..... 2.88  
 EQUALIZATN ..... 2.389  
 EQUALIZATN ..... 2.304  
 Equalizer ..... 2.88, 2.99, 2.102, 2.106, 2.114, 2.120  
 ..... 2.130, 2.210, 2.225  
 equalizer file, generation ..... 2.211, 2.225  
 Equalizer file, generator ..... 2.88  
 Equalizer table printout ..... 2.389  
 Equivalent ..... 2.122  
 Error messages ..... 2.51, 2.53  
   DFD measurement ..... 2.214  
   during program run ..... 2.53  
   Fatal ..... 2.54  
   MOD DIST measurement ..... 2.212  
   THD+N/SINAD measurement ..... 2.203  
 Error Messages  
   IEC/IEEE bus ..... 3.296  
 Error messages during measurement ..... 2.53  
 Error queue ..... 3.35  
 ESE (event status enable register) ..... 3.29  
 ESR (event status register) ..... 3.29  
 EVENT register ..... 3.26  
 Examples of application  
   external sweep with settling process ..... 2.48  
   quantising noise measurement ..... 2.175  
   Settling by arithmetic averaging ..... 2.42  
 Exec macro ..... 2.407  
 Explanations of Front- and Rearpanel Views ..... 2.3  
 EXPONENTIAL ..... 2.42, 2.175, 2.223  
 EXPORT ..... 2.305  
 Extension of file names ..... 2.294  
 Extern disp ..... 2.394  
 External  
   sweep ..... 2.159  
 external clock ..... 2.73  
 External Keyboard ..... 2.3
- F**
- Factor ..... 2.192, 2.249  
 FALLING ..... 2.232  
 FAST ..... 2.193, 2.206, 2.238, 2.250  
   analyzer ..... 2.201, 2.205, 2.213, 2.215  
 FAST DECAY ..... 2.254  
 Fast Fourier Transformation ..... 2.220  
 Fast frequency response measurement ..... 2.271  
 Fatal error  
   with error message ..... 2.53  
   without error message ..... 2.54  
 FDAS ..... 2.292  
 FFT ..... 2.101, 2.118, 2.165, 2.220, 2.278  
   amplitude accuracy ..... 2.226  
   frequency measurement ..... 2.226  
   implementation ..... 2.227  
   POST FFT ..... 2.172  
   Resolution ..... 2.173  
   Round noise ..... 2.226  
   Size ..... 2.173, 2.209  
   undersampling ..... 2.226  
   Window ..... 2.173  
 FFT ..... 2.15  
 FFT Size ..... 2.218, 2.221, 2.245  
 File  
   short form ..... 2.284  
 FILE ..... 2.3, 2.79, 2.81, 2.331, 2.332, 2.344, 2.354  
 FILE + AES3 ..... 2.79, 2.81  
 FILE + CRC ..... 2.79, 2.81  
 File attributes ..... 2.300  
 FILE DEF ..... 2.82, 2.374  
 File extensions ..... 2.294  
 File extensions ..... 2.321  
 FILE INTERN ..... 2.333  
 FILE NAME ..... 2.344  
 FILE panel ..... 2.294  
 File selection ..... 2.37  
 FILE/EPS ..... 2.372  
 FILE/HPGL ..... 2.372  
 FILE/PCX ..... 2.372  
 FILE/PS ..... 2.372  
 File-defined filter ..... 2.292  
 Filename ..... 2.36, 2.80, 2.81, 2.82, 2.125, 2.190, 2.301  
   ..... 2.306, 2.331, 2.351, 2.378  
 FILENAME RMS-sel. sweep ..... 2.191  
 Filter ..... 2.182, 2.194, 2.197, 2.208, 2.221, 2.229  
   ..... 2.232, 2.251, 2.254, 2.258, 2.278, 2.286, 2.287, 2.289  
   attenuation ..... 2.284  
   parameters ..... 2.291  
 FILTER ..... 2.172, 2.290  
 FILTER key ..... 2.3  
 Filter simulation ..... 2.229  
 FILTER SIMULATION ..... 2.165  
 First steps (readout of measurement results) ..... 3.340  
 First steps (readout of measurement results) (RS-232) .. 3.358  
 FIX 1000 MS ..... 2.197  
 FIX 200 MS ..... 2.197, 2.198  
 FIX 3 SEC ..... 2.197  
 FIX 50 MS ..... 2.197  
 FIX Range  
   Analyzer ..... 2.149  
   generator ..... 2.67  
 FIX: ..... 2.191  
 FLAT ..... 2.42, 2.175  
 FLAT TOP ..... 2.245  
 FLAT\_TOP ..... 2.222  
 FLOAT ..... 2.148  
 Floating inputs ..... 2.151  
 Floating reference values ..... 2.268  
 FM ..... 2.132  
 FNCT Ch1 ..... 2.262  
 FNCT Ch1&2 ..... 2.262  
 FNCT Ch2 ..... 2.262  
 Fnct Settl ..... 2.175, 2.182, 2.194, 2.197, 2.198  
   ..... 2.202, 2.208, 2.213, 2.215, 2.218  
 FOREVER ..... 2.254  
 Format ..... 2.135, 2.305, 2.354  
 Format Pha ..... 2.241  
 FrameCol ..... 2.374  
 FREQ ..... 2.95, 2.117  
 Freq Ch1 ..... 2.129  
 FREQ CH1 ..... 2.160, 2.191, 2.330, 2.344, 2.347  
 FREQ Ch1&2 ..... 2.128  
 Freq Ch2 ..... 2.129  
 FREQ CH2 ..... 2.160, 2.191, 2.330, 2.344, 2.347  
 FREQ FILE ..... 2.97, 2.141  
 Freq Mode ..... 2.128  
 FREQ MODE ..... 2.191, 2.249  
 FREQ MODE RMS sel. Sweep ..... 2.191  
 Freq No (i) ..... 2.103  
 Freq Settl ..... 2.175, 2.239, 2.242, 2.243  
 FREQ&PHASE ..... 2.128

- Frequency ..... 2.106, 2.109, 2.129, 2.135, 2.139, 2.140  
     difference ..... 2.115  
     generator ..... 2.99  
     Offset ..... 2.111  
     results ..... 2.59  
     units ..... 2.59  
 FREQUENCY ..... 2.136, 2.137  
 Frequency and phase measurement ..... 2.237  
 Frequency entry  
     SINE ..... 2.129, 2.139, 2.140  
 Frequency input  
     SINE ..... 2.99  
 frequency measurement  
     fast ..... 2.178  
 Frequency measurement ..... 2.237  
 Frequency measurement time ..... 2.238  
 Frequency measurement with FFT ..... 2.226  
 Frequency modulation ..... 2.132  
 Frequency response measurement  
     fast ..... 2.271  
 Frequency response measurement ..... 2.15  
 Frequency shift keying ..... 2.85  
 Frequency Sweep RMS sel ..... 2.187  
 Frequency units  
     reference value ..... 2.67, 2.75  
 Frequency, Phase and Group Delay ..... 2.240  
 Frequenzeingabe  
     SINE ..... 2.129  
 Front-panel ..... 2.3  
 FRQ FST CH1 ..... 2.160  
 FRQ FST CH2 ..... 2.160  
 Frq lim Low ..... 2.255  
 Frq Lim Low ..... 2.258  
 Frq lim Upp ..... 2.255  
 Frq Lim Upp ..... 2.259  
 Frq Offset ..... 2.86, 2.99, 2.111, 2.114, 2.128  
 FrqLim Low ..... 2.208, 2.251  
 FrqLim Upp ..... 2.208, 2.251  
 FSK ..... 2.85  
 Full scale value ..... 2.58  
 Full screen mode ..... 2.32, 2.29, 2.30  
 full-screen mode 3-panel display key ..... 2.32  
 FUNC CH1 ..... 2.330, 2.344, 2.347  
 FUNC CH2 ..... 2.330, 2.344, 2.347  
 Function  
     analyzer ..... 2.165, 2.166  
     generator ..... 2.85  
 FUNCTION  
     Generator ..... 2.85  
 Functions  
     changing of ..... 2.34  
 Functions of softkey ..... 2.341  
 Fundamental ..... 2.203  
 Fundamental frequency ..... 2.203  
 Fundamentl ..... 2.202, 2.207  
 Fuses ..... 1.2
- G**  
 Gain factor ..... 2.174  
     for notch filters ..... 2.174  
     MULTISINE ..... 2.104  
 GAUSS ..... 2.122  
 Gaussian distribution ..... 2.86  
 GEN CLK ..... 2.72, 2.74, 2.155  
 GEN CROSSED ..... 2.148  
 GEN key ..... 2.64  
 GEN key ..... 2.3
- GEN MLTSINE ..... 2.188  
 GEN TRACK ..... 2.170, 2.171, 2.174, 2.191, 2.202  
     2.207, 2.248, 2.249, 2.333  
 GEN1 ..... 2.148  
 GEN2 ..... 2.148  
 General Instructions for Use ..... 2.29  
 Generating a  
     sweep list ..... 2.303  
 Generation of a sweep list ..... 2.303  
 Generation of an  
     sweep list ..... 2.175  
 Generator  
     analog ..... 2.139  
     channels ..... 2.66  
     common parameters ..... 2.86  
     configuration ..... 2.66  
     frequency offset ..... 2.86  
     functions ..... 2.85  
     instruments ..... 2.65  
     settings ..... 2.17  
     signal functions ..... 2.85  
     sweeps ..... 2.91  
 GENERATOR ..... 2.64  
 Generator source impedance ..... 2.66  
 Generator sweep  
     linear step size ..... 2.96  
 Generator tracking  
     fundamental THD ..... 2.202  
     linearity measurement ..... 2.268  
     Notch filter frequency ..... 2.174  
 GENTRACK  
     RMS measurement speed ..... 2.185  
     RMS measuring speed ..... 2.180  
 Gibb's phenomenon ..... 2.196  
 GRAPH ..... 2.3, 2.32  
 Graphic Display  
     Colour Selection ..... 2.395  
 Graphic window ..... 2.31  
 Graphical data presentation ..... 2.327  
 Graphical display  
     MOD DIST measurement ..... 2.213  
     THD measurement ..... 2.202  
 GROUND  
     analyzer ..... 2.148  
 Group delay ..... 2.144  
 GROUP DELAY ..... 2.331, 2.344, 2.347  
 Group of scans ..... 2.326  
 Group of traces ..... 2.303, 2.330  
 group-delay measurement ..... 2.233
- H**  
 H COPY key ..... 2.5, 2.371  
 HAMMING ..... 2.222, 2.245  
 Handshake ..... 2.392  
 HANN ..... 2.222, 2.245  
 Hard copy ..... 2.371  
 Hard copy of screen ..... 2.5  
 Hardcopy  
     PCX Images ..... 2.298  
 hardware options ..... 2.401  
 HARM ..... 2.343  
 Harmonics ..... 2.200  
 HCOPY key ..... 2.298  
 Header ..... 3.7  
 Headphone/Speaker output ..... 2.260  
 Headphones ..... 2.260  
 help ..... 2.15

- Help ..... 2.15  
     functions ..... 2.55  
     texts ..... 2.55  
 Help during entry ..... 2.36  
 Help for graphics softkeys ..... 2.55  
 Help functions ..... 2.393  
 HELP key ..... 2.7  
 HEX ..... 2.354  
 Hex display of measurement results ..... 2.58  
 High level time for SINE BURST ..... 2.108  
 HIGH PASS ..... 2.286  
 Highpass filter ..... 2.286  
 Histogram  
     DFD ..... 2.215  
     MODDIST ..... 2.213  
     THD ..... 2.199  
 HLINE ..... 2.340, 2.341  
 HOLD ..... 2.330, 2.333, 2.344  
 Hold time ..... 2.254  
 HPGL data ..... 2.372
- I**
- IEC 118 ..... 2.115  
 IEC 268 ..... 2.115  
 IEC 386 standard W&F ..... 2.217  
 IEC 61937 ..... 2.134  
 IEC Adr ..... 2.379  
 IEC BUS ..... 2.379, 2.390  
 IEC TUNER ..... 2.208  
 IEC/IEEE bus  
     address ..... 3.4  
     connection ..... 2.408  
     interface ..... 3.293  
     functions ..... 3.294  
     messages ..... 3.295  
 IEC/IEEE-bus  
     address ..... 2.390  
 IEC/IEEE-bus control ..... 3.345  
 IEC/IEEE-bus interface ..... 2.390  
 IMAX A ..... 2.343  
 IMAX B ..... 2.343  
 Impedance  
     analyzer ..... 2.148  
 Implementing the FFT ..... 2.227  
 Info Disp ..... 2.300  
 Info Text ..... 2.300  
 INP RMS CH1 ..... 2.330  
 INP RMS CH2 ..... 2.330  
 Input ..... 2.148, 2.154  
     analyzer ..... 2.148  
     channels ..... 2.146  
     generator ..... 2.66  
     impedance ..... 2.148  
 INPUT Ch1 ..... 2.262  
 INPUT Ch1&2 ..... 2.262  
 INPUT Ch2 ..... 2.262  
 INPUT COMMON ..... 2.262  
 Input connectors of analyzers  
     analog ..... 2.9  
     digital ..... 2.9  
 INPUT DISP ..... 2.235  
     DIGital INPut AMPlitude ..... 2.236  
     PEAK ..... 2.236  
     PHASE ..... 2.235  
     PHASe TO REF ..... 2.236  
     RMS ..... 2.236  
 Input during a measurement, data output ..... 2.39  
 Input interface ..... 2.154  
 INPUT JITTER ..... 2.262  
 input peak value ..... 2.235  
 Input unit (IEC/IEEE-bus) ..... 3.18  
 INPUT/PHAS ..... 2.235  
     PHASE ..... 2.235  
 INPUT? - Press SHOW I/O ..... 2.53  
 Installation  
     hardware options ..... 1.5  
     MS-DOS operating system ..... 1.8  
     software options ..... 1.5  
     UPL operating and measurement software ..... 1.8  
     UPL software ..... 1.8  
 Installation der UPL-Bedien- und Meßsoftware ..... 1.9  
 Instructions for Use, General ..... 2.29  
 Instrument  
     change ..... 2.33  
 Instrument model (IEC/IEEE-bus) ..... 3.18  
 Instrument status, loading and storing ..... 2.296  
 Integration effect ..... 2.198  
 Integration time ..... 2.181  
 Interchannel delay ..... 2.220  
 Interface functions ..... 3.294  
 Interface message  
     DCL ..... 3.18  
     GET ..... 3.19  
     LLO ..... 3.5  
 Interface messages ..... 3.295  
 Interfaces  
     COM1, COM2 ..... 2.408  
     RS-232 ..... 2.408  
 Interference level  
     measurement results ..... 2.59  
     units ..... 2.59  
 Interfering  
     frequency ..... 2.112  
     signal ..... 2.111  
     sinewave signal ..... 2.212  
 Intermodulation  
     components ..... 2.214  
 Intermodulation measurement  
     DFD ..... 2.214  
     MOD DIST ..... 2.212  
 Intermodulation product ..... 2.212  
 INTERN ..... 2.154  
 INTERN ONLY ..... 2.394  
 Internal  
     signal connection analyzer - generator ..... 2.148  
 Internal signal paths ..... 2.151  
 Interpol ..... 2.233  
 Interpolated maximum ..... 2.343  
 Interpolated values ..... 2.337  
 Interpolation steps ..... 2.233  
 Interpolation to a common X Axis ..... 2.325  
 Interpretation file for channel status data ..... 2.354  
 Interpretation file for user data ..... 2.355  
 Interpretation mode ..... 2.354  
 INTERVAL ..... 2.90, 2.95, 2.105, 2.108, 2.110, 2.123, 2.126  
 Interval for SINE BURST  
     monitoring interval ..... 2.196  
     Monitoring interval for peak value detection ..... 2.197  
 interval length ..... 2.90  
 Interval time ..... 2.95, 2.197  
 Interval time ..... 2.95  
 Introduction  
     operation UPL ..... 2.15  
 INTV FILE ..... 2.98  
 Intv Time ..... 2.197  
 Invert1/n ..... 2.306  
 IST flag ..... 3.29

## J

JIS standard W&F .....	2.217
JITTER .....	2.71, 2.138
Jitter Freq .....	2.140
Jitter Peak Ampl .....	2.140
Jitter Ref .....	2.155
JITTER/PHAS .....	2.71, 2.153

## K

KAISER .....	2.222
KEEP .....	2.341
Key	
[LOCAL]	
lock .....	3.5
DISPLAY .....	2.327
FILE .....	2.294
GRAPH .....	2.32
H COPY .....	2.371
OFF LCD .....	2.394
OPTIONS .....	2.381
OUTPUT OFF .....	2.371
SHOW I/O .....	2.370
STATUS .....	2.293
STOP CONT .....	2.370
Key combinations	
ALT .....	2.31
Ctrl D .....	2.394
of external keyboard .....	2.3, 2.32
Keyboard settings .....	2.393
Keys of the front panel .....	2.5, 2.31
Keys, front panel	
ANLR .....	2.278
GEN .....	2.64
TAB .....	2.64, 2.142, 2.278
Keyword	
form .....	3.8
Keywords of the protocol file .....	2.354

## L

L 448 kb/s .....	2.135
LANDSCAPE .....	2.376
Language .....	2.393
Language of help texts .....	2.393
LCD .....	2.7
Contrast .....	2.394
LED	
REM .....	3.4
Left .....	2.336
Left Mrgn .....	2.375
LEFT/BOTTOM .....	2.348
Legend of graphic symbols .....	2.1
LEV all di .....	2.200
LEV even di .....	2.200
LEV odd di .....	2.200
LEV SEL di .....	2.200
LEV TRG CH1 .....	2.161
LEV TRG CH2 .....	2.161
Level	
ratio .....	2.113
Level control monitor output .....	2.260
Level entry	
Coded Audio .....	2.137

## Level measurement

DC .....	2.198
PEAK .....	2.196
QUASI-PEAK .....	2.196
RMS .....	2.178
RMS SELECT .....	2.184
LEVEL NOISE .....	2.205
LEVEL THDN .....	2.205
Level units .....	2.58
LFE 448 kb/s .....	2.135
LIM LOW&UP .....	2.350
LIM LOWER .....	2.389
Lim Lower .....	2.350
LIM LOWER .....	2.304, 2.350
LIM REPORT .....	2.389
Lim Upper .....	2.350
LIM UPPER .....	2.304, 2.350, 2.389
Limit	
check .....	2.318, 2.319, 2.337, 3.349, 2.350, 3.19
curve .....	2.350
over/underrange .....	2.317
violation .....	2.318
Limit curve	
printing .....	2.389
storing .....	2.304
value .....	2.326
Limit curve .....	2.350
Limit exceeded .....	2.350
Limit exceeded, printout .....	2.389
Limit files	
editing .....	2.312
generated from trace file .....	2.314
generation by means of application program .....	2.317
header .....	2.312
measured values .....	2.312
Limit frequency of analyzer instruments .....	2.143
Limit frequency/cutoff frequency	
FFT frequency measurement .....	2.237
Limit report list .....	2.317
Limit value .....	2.351
LIN .....	2.348
LIN POINTS	
Analysator .....	2.189
generator .....	2.96
LIN Spacing .....	2.335
LIN STEPS .....	2.189
generator .....	2.96
Line .....	2.398
Line Count .....	2.253
Line diagram .....	2.327
Linear step size	
generator sweep .....	2.96
Linearity Measurements .....	2.268
List sweep .....	2.91
buffers .....	2.91
generator .....	2.91, 2.93
storing .....	2.303
LLO .....	3.5
LOAD INSTRUMENT .....	2.296
Loading	
and Storing .....	2.294
files .....	2.294
instrument setups .....	2.296
Loading of setups .....	2.299
Loading the default setup .....	2.15
LOCAL .....	2.7
Local timecode and CRC .....	2.79
lock error .....	2.365
LOG .....	2.348
LOG POINTS	
analyzer .....	2.189

- generator..... 2.96
- LOG Spacing..... 2.335
- LOG STEPS
  - analyzer..... 2.189
  - generator..... 2.96
- Logarithmic step size
  - generator sweep..... 2.96
  - RMS sel. sweep..... 2.189
- LONG CABLE..... 2.72
- Long form (command)..... 3.8
- Loudspeaker..... 2.260
- Loudspeaker Measurements..... 2.246
- Low Dist..... 2.99, 2.399
- low frequency enhancement..... 2.135
- Low Level..... 2.107
- Low level time for SINE BURST..... 2.107
- LOW PASS..... 2.286
- Low-distortion generator..... 2.109
- Low-distortion generator..... 2.203
- Lower case (command)..... 3.37
- Lower Freq..... 2.121
- LOWER FREQ..... 2.112
- Lower frequency limit..... 2.153
- Lower frequency range limit..... 2.146
- LOWERV..... 2.149
- Lowpass filter..... 2.286
- LPT1..... 2.379
- LS 448 kb/s..... 2.135
  
- M**
- Mainlobe..... 2.222
- MANU LIST
  - Generator-Sweep..... 2.93
- MANU LIST..... 2.188
- MANU SWEEP
  - analyzer..... 2.188
  - Generator-Sweep..... 2.93
- MANUAL..... 2.335, 2.348, 2.397
- Manual control..... 3.5
- Manual Operation..... 2.1
- Manual sweeps
  - generator..... 2.93
  - operation..... 2.360
- MARKER..... 2.341, 2.342, 2.343
- Marks comment lines..... 2.322
- MAX..... 2.332, 2.334, 2.345, 2.347
- Max hold..... 2.254
- Max Hold..... 2.257
- MAX HOLD..... 2.328
- Max Volt..... 2.67, 2.75
- Maximum of measurement series..... 2.343
- Maximum peak value..... 2.165
- Maximum values bargraph..... 2.349
- MD5-Signaturverfahren (RS232)..... 3.364
- MEAN FREQ..... 2.115, 2.121
- MEAS CH1..... 2.170, 2.171, 2.333
- MEAS CH2..... 2.170, 2.171, 2.333
- Meas Disp..... 2.394
- Meas Mode..... 2.153, 2.196, 2.200, 2.205, 2.215
- Meas time..... 2.238, 2.248, 2.253
- Meas Time..... 2.179, 2.180, 2.185, 2.198, 2.206, 2.224, 2.257
  - RMS measurement..... 2.179
  - RMS SELECT measurement..... 2.185
- Measured value
  - buffer..... 2.160
  - stabilization..... 2.41, 2.47, 2.1772, 177
- Measured value and status displays..... 2.394
- Measured value resolution..... 2.45, 2.176
- Measurement
  - range selection..... 2.149
- Measurement Display
  - ON/OFF..... 2.394
  - Readin Rate..... 2.395
  - Reading Resolution..... 2.395
- Measurement function
  - reference values..... 2.169
- Measurement range..... 2.150
- Measurement range limit
  - analyzer instruments..... 2.143
  - lower..... 2.146
  - upper..... 2.143
- Measurement rate..... 2.179, 2.185
- Measurement results, display window..... 2.40
- Measurement time..... 2.253, 2.257
- Measurement valid/invalid..... 2.39
- Measurement, input during..... 2.39
- Measurements..... 2.358
- Measuring..... 2.299
- Measuring time..... 2.179, 2.185
- Measuring time FFT..... 2.227
- Memory expansion..... 4.4, 4.5
- Messages on operating state..... 2.51
- Meßzeit..... 2.257
- Min Freq..... 2.146, 2.153
- Min VOLT..... 2.163
- Minimum value of resolution during settling..... 2.45
- Minimum voltage..... 2.163
- Mod Depth..... 2.132
- MOD DIST
  - analyzer..... 2.165, 2.212
  - generator..... 2.111
  - Generator..... 2.85
- Mod Freq..... 2.89, 2.105, 2.123, 2.126, 2.132
- MODDIST signal
  - measuring on..... 2.180
- Mode..... 2.115, 2.298, 2.299, 2.330, 2.350
  - LOCAL..... 3.4
  - REMOTE..... 3.4
- Modulation
  - factor analysis..... 2.109
- MODULATION..... 2.85, 2.132
- modulation deviation
  - AM..... 2.89, 2.105, 2.123
- Modulation deviation
  - AM..... 2.126
- Modulation distortion..... 2.85
- modulation distortion
  - measurement..... 2.212
- modulation frequency
  - AM..... 2.89, 2.139
- Modulation frequency
  - AM..... 2.126
  - FM..... 2.132
- MODULATION function..... 2.89
- Modulationshub
  - AM..... 2.126
  - FM..... 2.132
- Monitor output..... 2.261
- MORE..... 2.341
- mouse
  - scrolling in the panel..... 2.32
- mouse..... 2.36
  
- Mouse
  - connection of..... 2.408
  - numeric entry..... 2.35
- mouse functions..... 2.64, 2.142, 2.278
- Mouse Operation..... 2.29
- Multichannel..... 2.135
- Multisine

dialog window ..... 2.103  
 MULTISINE ..... 2.85, 2.101

## N

NAB ..... 2.217  
 NAB standard W&F ..... 2.217  
 NARROW ..... 2.206  
 Next step ..... 2.94  
 NEXTHARM ..... 2.343  
 No of sine ..... 2.103  
 Noise  
   distribution ..... 2.122  
   spacings ..... 2.117  
   suppression (THD) ..... 2.199  
   weighting (THD+N/SINAD) ..... 2.203  
 Noise ..... 2.117  
 NOISE ..... 2.205  
 Noise component ..... 2.86  
 Nominal AC supply voltage ..... 1.1  
 NONE ..... 2.78  
 NORMAL ..... 2.182, 2.193, 2.223, 2.250  
 Normalize ..... 2.334  
 Normalized frequency response ..... 2.305  
 Normfreq ..... 2.305  
 NOT EQUAL A ..... 2.332  
 Notch ..... 2.289  
   analog filter ..... 2.174  
   characteristic ..... 2.174  
   freq ..... 2.174  
   gain ..... 2.174  
 Notch (Gain) ..... 2.174, 2.182, 2.194, 2.197, 2.221  
 NOTCH FLT ..... 2.289  
 Notch Freq ..... 2.174  
 Note on delay ..... 2.47  
 NTRansition register ..... 3.26  
 number of thirds ..... 2.253  
 Numeric values (command) ..... 3.13

## O

o CURSOR ..... 2.332, 2.334, 2.342, 2.345  
 o TO \* ..... 2.340  
 Octave ..... 2.290  
 Octave ..... 2.290  
 Octave filter ..... 2.290  
 Octave Filter ..... 2.290  
 OCTAVE FLT ..... 2.290  
 OFF LCD key ..... 2.394  
 ON TIME ..... 2.90, 2.95, 2.105, 2.108, 2.110, 2.123, 2.126  
 one-dimensional sweep ..... 2.95  
 ONTIM FILE ..... 2.98  
 Opening the instrument ..... 4.7  
 Operating mode (IEC/IEEE)  
   LOCAL ..... 3.358  
   REMOTE ..... 3.358  
 Operating states of sweep system ..... 2.363  
 Operating system level ..... 2.294  
 OPERATION ..... 2.327, 2.328, 2.352  
 OPTICAL ..... 2.154  
 OPTIMIZED ..... 2.102, 2.120  
 Optimizing  
   Frequency Response ..... 2.277  
   measurement speed ..... 2.272  
   settling parameters ..... 2.49

Option  
   Universal Sequence Controller (UPL B10) ..... 3.337  
 Options  
   enabling ..... 1.5, 1.7  
 OPTIONS key ..... 2.5  
 Order of a Filter ..... 2.286  
 Orientation ..... 2.376  
 OTHER TRACE ..... 2.333  
 Output ..... 2.7, 2.66, 2.139  
   Impedance ..... 2.66  
   power ..... 2.70  
 Output BAL ..... 2.69  
 output clock rate ..... 2.73  
 Output clock rate ..... 2.157  
 Output impedance ..... 2.139  
 Output of block data (B10) ..... 3.342  
 Output of commands  
   Output of commands ..... 3.341  
   Output of commands (B10) ..... 3.341  
 OUTPUT OFF key ..... 2.371  
 output UNBAL ..... 2.68  
 output voltage  
   bal ..... 2.75  
   unbal ..... 2.75  
 Output voltage  
   limit value ..... 2.67, 2.75  
   limitation ..... 2.75  
 Overlapping execution ..... 3.19  
 OVERlay/Max Hold ..... 2.330  
 Overloading DC measurement ..... 2.198  
 Overshoots ..... 2.196  
 Overview of measurement and sweep systems ..... 2.358

## P

PAGE ..... 2.13  
 Pair of traces ..... 2.303, 2.325, 2.330, 2.332  
 Panel ..... 2.31, 2.39, 2.79, 2.81  
   ANALYZER ..... 2.142  
   DISPLAY ..... 2.327, 2.330, 2.347  
   FILE ..... 2.294  
   FILTER ..... 2.278  
   OPTIONS ..... 2.390  
   scrolling ..... 2.32  
   STATUS ..... 2.293  
 Panel ..... 2.327  
 PANEL ..... 2.81  
 PANEL + AES 3 ..... 2.79, 2.819  
 PANEL + CRC ..... 2.79, 2.81  
 PANEL OFF ..... 2.78  
 Panel selection ..... 2.31  
 Panelfile ..... 2.83  
 Panels  
   changing ..... 2.29, 2.30  
   changing between ..... 2.31  
   changing using the keyboard ..... 2.31  
   changing using the mouse ..... 2.31  
   position on the screen ..... 2.32  
 Paper Size ..... 2.379  
 Parallel poll ..... 3.34  
 Param. Link ..... 2.403  
 Parameter (command) ..... 3.13  
 Parameter Link ..... 2.33, 2.34, 2.403  
 Parameters  
   changing ..... 2.34  
   display panel ..... 2.330, 2.347  
   list display ..... 2.344  
   selection ..... 2.34

- Parity ..... 2.391, 2.409
- Parser ..... 3.19
- Partial setup, loading and storing ..... 2.296
- Part-screen graphics ..... 2.357
- Passb Low ..... 2.287
- Passb Upp ..... 2.287
- Passband ..... 2.286
- Password protection ..... 2.402
- Path ..... 2.36
- PDF ..... 2.86, 2.99, 2.111, 2.114, 2.122, 2.128
- PEAK ..... 2.235
- PEAK & S/N ..... 2.165
- PEAK measurement ..... 2.196
- Peak value detector ..... 2.165, 2.196
- Peak weighting ..... 2.196
- Peak-to-peak amplitude
- MOD DIST ..... 2.113
  - MULTISINE ..... 2.104
  - POLARITY ..... 2.127
  - SINE ..... 2.100, 2.139, 2.140
  - SINE BURST ..... 2.107
  - SINE<sup>2</sup> BURST ..... 2.109
- Periodic tracings of measured values ..... 2.160
- PERMANENT ..... 2.263
- Permissible range of values ..... 2.36
- Phas Ch2
- 1 ..... 2.130
- Phas Settl ..... 2.175, 2.242
- PHAS TO REF ..... 2.235
- Phase
- digital ..... 2.71
  - frame (jitter) ..... 2.235
  - measurement results ..... 2.59
  - optimization ..... 2.117
  - position sine voltage with MULTISINE ..... 2.101
  - reference value ..... 2.172
  - units ..... 2.59
- PHASE ..... 2.330, 2.344, 2.347
- Frame Phase ..... 2.235
- Phase difference ..... 2.240
- phase measurement ..... 2.144
- Phase No (i) ..... 2.103
- Phase Reference value ..... 2.172
- PHASE TO REF ..... 2.166
- PhaseToRef ..... 2.400
- Phone ..... 2.263
- Phone Out ..... 2.177
- PINK ..... 2.118
- Pink noise ..... 2.118
- Plot on ..... 2.379
- Plots/Page ..... 2.380
- PLOTTR/HPGL ..... 2.372
- Points
- analyzer ..... 2.163, 2.190
  - generator ..... 2.97
- Polarity
- measurement ..... 2.219
  - Polarity measurement ..... 2.85
  - test ..... 2.127
  - Test ..... 2.219
- POLARITY ..... 2.85
- analyzer ..... 2.127
  - generator ..... 2.165
- Polarity reversal ..... 2.219
- Polarity Test ..... 2.219
- Poles ..... 2.292
- PORTRAIT ..... 2.376
- Post FFT ..... 2.183
- POST FFT ..... 2.173, 2.209
- Post FFT RMS measurement ..... 2.183
- Post-FFT ..... 2.218
- Potential reference ..... 2.149
- Power supply ..... 1.1
- PPE (parallel poll enable register) ..... 3.29
- Pre Gain ..... 2.177, 2.263
- PRECISION ..... 2.238
- analyzer ..... 2.201, 2.205, 2.213, 2.215
- Precision of frequency measurement ..... 2.238
- Preparation for use (RS232) ..... 3.357
- Print
- format ..... 2.376
- Printer
- output ..... 2.389
- PRINTER ..... 2.371
- Printing traces and lists ..... 2.389
- Printname ..... 2.373
- Printout ..... 2.376
- PRINTR/HPGL ..... 2.372
- PRINTR/PS ..... 2.372
- Pm Hight ..... 2.379
- Pm Resol ..... 2.376
- Pm Width ..... 2.379
- Program example
- Readout of results in R&S BASIC ..... 3.360
- Program examples
- Readout of Measurement results (B-10) ..... 3.340
  - Readout of measurement results in Borland-C 3.0... 3.361
  - Result readout in QuickBASIC ..... 3.359
- Programming examples ..... 3.300
- Programming model
- UPL analyzer ..... 3.17
  - UPL generator ..... 3.16
- Prolog for HPGL ..... 2.294
- PROTO AUTO ..... 2.352
- Proto File ..... 2.354, 2.355
- protocol ..... 2.78
- PROTOCOL ..... 2.78, 2.165, 2.328, 2.352
- PROTOCOL analysis ..... 2.352
- PTRansition register ..... 3.25
- Pulse duration SINE2 BURST ..... 2.110
- Pulse spectrum ..... 2.222
- ## Q
- Q PK & S/N ..... 2.165
- Quantising noise measurement ..... 2.175
- Quasi-PEAK measurement ..... 2.196
- Quasi-peak weighting ..... 2.191
- Query
- form ..... 3.7
  - response ..... 3.11
- Question mark ..... 3.15



## R

- R 448 kb/s ..... 2.135
  - Rackmounting..... 1.1
  - RAM drive..... 1.7, 2.134
  - RANDOM ..... 2.85
  - Range..... 2.149
    - overranges ..... 2.51
    - rated value ..... 2.149, 2.150
    - spacing..... 2.150
    - unterranges ..... 2.51
  - Ranges..... 2.150
  - READ ONLY..... 2.300
  - Read Rate ..... 2.395
  - Read Resol..... 2.395
  - READ.ME..... 1.9
  - READ/WRITE..... 2.300
  - Reading in responses (B10) ..... 3.341
  - Reading out block data (B10) ..... 3.342
  - Readout of measurement results
    - in Borland-C 3.0 ..... 3.361
    - in R&S BASIC ..... 3.360
    - Univ. Sequence Controller UPL-B10..... 3.340
  - Readout of Measurement Results
    - in QuickBASIC ..... 3.359
  - REAL..... 2.305
  - Rear view ..... 2.10, 2.11
  - RECTANGLE..... 2.86
  - RECTANGULAR..... 2.222, 2.245
  - Ref Freq ..... 2.67
    - Analysator ..... 2.243
    - analyzer..... 2.171, 2.239, 2.241
  - Ref Frq ..... 2.75
  - REF GEN ..... 2.74
  - Ref Imped..... 2.146
  - REF IN..... 2.72, 2.74, 2.156
  - Ref Out
    - Data ..... 2.74
    - Source..... 2.74
  - Ref Phase..... 2.172, 2.242
  - Ref Volt..... 2.68, 2.76, 2.232
  - Reference..... 2.169, 2.170, 2.181, 2.186, 2.197, 2.198, 2.201
    - ..... 2.206, 2.220, 2.236, 2.248, 2.254, 2.258, 2.332
    - ..... 2.333, 2.345, 2.347
    - impedance..... 2.146
    - point DC measurement..... 2.198
    - trace was stored in the file..... 2.333
    - traces ..... 2.332
    - traces ..... 2.302, 2.324
    - value depend..... 2.335
    - variable..... 2.302
  - Reference measurement potential ..... 2.149
  - Reference value
    - storage on key stroke ..... 2.172
  - Reference values
    - floating..... 2.268
    - group-delay measurement..... 2.172
    - phase measurement..... 2.172
  - Rejection ..... 2.206
  - Release control..... 3.345
  - Remote control ..... 3.1
  - Remote control via RS-232 interface ..... 3.357
  - Remote via ..... 2.390
  - Rep delay ..... 2.393
  - Rep rate..... 2.393
  - Repetition delay..... 2.393
  - Repetition rate ..... 2.393
  - Repetitive triggering..... 2.393
  - Replace
    - the SETUP battery ..... 4.8
  - Resolution
    - FFT ..... 2.173, 2.210, 2.218, 2.224, 2.227, 2.245
    - Settling..... 2.50, 2.176
  - Resolution value..... 2.50
  - Restart
    - of a measurement ..... 2.359
    - of sweep ..... 2.160
    - of the last valid setting ..... 2.53
    - of the UPL..... 2.54
    - of the UPL with default setting ..... 2.54
  - retry..... 2.410
  - Return to manual operation (RS-232)..... 3.358
  - RIFE-VINC 1 ..... 2.222, 2.245
  - RIFE-VINC 2 ..... 2.222, 2.245
  - RIFE-VINC 3 ..... 2.222, 2.245
  - Right ..... 2.336
  - RIGHT/TOP ..... 2.348
  - Ripple..... 2.287
  - RISING..... 2.232
  - RMS..... 2.178, 2.235
  - RMS & S/N..... 2.165
  - RMS S/N ..... 2.178
  - RMS SELECT ..... 2.165, 2.184
  - RMS value incl. S/N ..... 2.178
  - rollkey ..... 2.53
  - Rotary knob..... 2.7
  - Rounding noise ..... 2.227
  - RS-232 interface ..... 2.390
  - RS 448 kb/s ..... 2.135
  - RS-232 (COM1, COM2) ..... 2.408
  - RS-232 interface
    - Differences to the IEC/IEEE bus ..... 3.364
    - First steps (readout of measurement results)..... 3.358
    - Preparation for use..... 3.357
    - Return to manual operation..... 3.358
  - RS-232 Interface
    - Switchover to Remote Control..... 3.358
  - RTS/CTS..... 2.392
  - RUB & BUZZ..... 2.165
  - Rub & Buzz Measurements ..... 2.246
  - Rub&Buzz ..... 2.278
  - RUMBLE UNW..... 2.208
  - RUMBLE WTD..... 2.208
- ## S
- S/N measurement ..... 2.167
  - S/N Sequ..... 2.167, 2.178, 2.196
  - Sample..... 2.42, 2.50
  - Sample frequency
    - maximum ..... 2.157
  - Sample Frequency
    - analyzer ..... 2.157
    - generator ..... 2.73
  - Sample Frq
    - Analyzer..... 2.157
    - Generator..... 2.73
  - Sample Mode ..... 2.405
  - Sample rate
    - filter..... 2.291
  - Samples ..... 2.175
  - Sampling Frequency
    - Measurement..... 2.243
  - Scale..... 2.335, 2.348
  - Scale B ..... 2.332
  - Scan conf..... 2.397
  - Scan Count ..... 2.329
  - Scan count =1 ..... 2.324
  - Scan count >1 ..... 2.325
  - Scan index ..... 2.337

Scan index.....	2.7, 2.325	Short name of filters.....	2.284
Scannr.....	2.397	Shortname.....	2.285
SCPI		SHOW I/O.....	2.5, 2.370
introduction.....	3.7	key.....	2.370
keywords.....	3.8	messages.....	2.53
SCREEN.....	2.373	SHOW I/O.....	2.40
Screen copies		Signal amplification.....	2.261
plotting.....	2.381	Signal period matching.....	2.179, 2.185
printing.....	2.381	Signal spectrum.....	2.222
storing.....	2.381	Signal-to-noise measurement.....	2.167
Scrolling in the panel.....	2.32	Signaturverfahren MD5 (RS232).....	3.364
SELECT.....	2.5, 2.16	Simulation.....	2.172, 2.278
SELECT di.....	2.200	Simulation.....	2.229
Selection		SINAD.....	2.205
commands.....	2.83	Sine.....	2.85
file.....	2.37	SINE.....	2.85, 2.89, 2.105, 2.122, 2.126
of a Parameter.....	2.34	SINE.....	2.99
Selection of analyzer.....	2.142	SINE BURST.....	2.85
Selection of function		Sine burst signal.....	2.85
brief introduction.....	2.14	SINE <sup>2</sup> BURST.....	2.85
Selection of generator.....	2.65	SINE <sup>2</sup> BURST.....	2.127
Selective rms measurement.....	2.165	SINE <sup>2</sup> BURST signal.....	2.219
Selective rms value.....	2.184	Sinewave amplitude	
SELECTP.....	2.379	MULTISINE.....	2.104
Selftest.....	1.3	SINE.....	2.100
Semicolon.....	3.15	SINE BURST.....	2.107
Sequence Control (opt. UPL B10).....	3.337	SINE <sup>2</sup> BURST.....	2.109
Sequence of operation in the panels.....	2.29, 2.30	Sinewave amplitude SINE.....	2.139, 2.140
Serial poll.....	3.34	Sinewave frequency	
Series of data.....	2.302	MULTISINE.....	2.103
Series of measured values.....	2.324	SINE BURST.....	2.106
Service functions.....	2.401	SINE <sup>2</sup> BURST.....	2.109, 2.110, 2.112, 2.113, 2.115
Service request.....	3.33	Sinewave signal.....	2.138
SET TO.....	2.340	Single	
SETREF.....	2.341, 2.343	key.....	2.160
Setting and displaying auxiliary.....	2.390	SINGLE.....	2.5
Setting parameters.....	2.13	SINGLE.....	2.363, 2.364
Setting the Display Parameters.....	2.18	SINGLE key.....	2.360
Setting, switching off the displays.....	2.394	Single measurement.....	2.5, 2.160
Settling.....	2.164, 2.175	Single measurement at fixed intervals.....	2.163
delay with external sweep		Single measurements.....	2.358
control.....	2.45	Single sine.....	2.101
resolution.....	2.45	Sinusamplitude SINE.....	2.130
introduction.....	2.41	SLOW.....	2.206
optimizing the parameters.....	2.48	SLOW DECAY.....	2.254
process		Smoothed display.....	2.233
measurement run with external sweep.....	2.47	SMPTE.....	2.111
Settling.....	2.41	SMPTE measurement procedure.....	2.212
SETTLING		Softkey menus.....	2.337
check.....	2.48	Softkeys.....	2.9, 2.35
Settling by arithmetic averaging.....	2.42	Softkeys.....	2.339
Settling condition.....	2.42	software options.....	2.401
Settling delay with external sweep.....	2.50	installing.....	1.5
Settling parameter		Software options	
optimizing.....	2.49	enabling.....	1.5
Settling parameters.....	2.42	.....	1.7
settling process		installation.....	1.5
combination.....	2.41	.....	1.7
Settling process.....	2.175	new installation of.....	1.5
possible combinations.....	2.41	.....	1.7
Settling process.....	2.41	Software Options	
Settling time		enabling.....	1.5
filter.....	2.284	source.....	2.66
Settling tolerance.....	2.42	Source.....	2.139, 2.353
SETUP.....	1.3, 2.298	Source impedance.....	2.66, 2.139
Shape.....	2.118	Source impedance.....	2.66
Shape file.....	2.119	Space.....	3.15
Shielded cables.....	2.408	Spacing.....	2.96, 2.101, 2.118, 2.189, 2.335, 2.348
Short circuit		Span.....	2.224
generator output.....	2.70	Span FFT.....	2.227
Short form (command).....	3.8	SPC LIM REP.....	2.327
		SPEAKER.....	2.177, 2.183, 2.194, 2.197, 2.198, 2.202

.....	2.213, 2.215, 2.218, 2.225, 2.229, 2.233, 2.251, 2.255
.....	2.259, 2.262
Speaker off.....	2.260
SPECTR LIST.....	2.327
SPECTRUM.....	2.328
Spectrum Analysis.....	2.220
SPEKER.....	2.219
Spk Volume.....	2.177, 2.263
Spurious emissions.....	2.408
SRE (service request enable register).....	3.28
SRQ (service request).....	3.33
Standard.....	2.217
STANDARD.....	2.231
Standard W&F.....	2.217
Start.....	2.163, 2.173, 2.189, 2.210, 2.218, 2.223, 2.245
generator sweep.....	2.96
START.....	2.5
START COND.....	2.159, 2.160
START COND.....	2.39
Start condition.....	2.159
START key.....	2.160
START key.....	2.360, 2.363, 2.364
Start of arithmetic averaging.....	2.42
Start Options.....	1.10
Start/stop limits for triggering.....	2.163
Starting and stopping of measurements or sweeps.....	2.358
State diagram	
measurement.....	2.359
sweep.....	2.360
STATIC.....	2.78
Status	
display.....	2.117
Status byte.....	3.28
Status diagram	
sweep.....	2.360
Status display	
ANL status.....	2.51
GEN ORUN.....	2.73
GEN status.....	2.51
SWP status.....	2.52
Status display.....	2.51, 2.52
Status displays.....	2.358
Status information.....	2.40
STATUS key.....	2.3
Status operation register.....	3.30
Status panel.....	2.32
STATUS panel.....	2.293
Status questionable register.....	3.31
Status register	
condition part.....	3.25
enable part.....	3.26
error queue.....	3.35
event part.....	3.26
event status enable register.....	3.29
event status register.....	3.29
IST flag.....	3.29
ntransition part.....	3.26
overview.....	3.27
parallel poll enable register.....	3.29
ptransition part.....	3.25
service request enable register.....	3.28
status byte.....	3.28
status operation register.....	3.30
status questionable register.....	3.31
structure.....	3.25
summary bit.....	3.26
Status reporting system.....	3.24
resetting.....	3.36
use.....	3.33
steady readout by settling.....	2.41
Step	
generator.....	2.97
RMS sel. sweep.....	2.190
Step size	
linear generator sweep.....	2.96
logarithmic generator sweep.....	2.96
STEREO SINE.....	2.85, 2.128
Stop.....	2.163, 2.173, 2.210, 2.218, 2.224, 2.245, 2.409
generator sweep.....	2.96
Stop.....	2.5
STOP.....	2.358
Stop Bits.....	2.391
STOP CONT key.....	2.370
STOP key.....	2.161
STOP/CONT.....	2.5
STOP/CONT.....	2.363, 2.364
Stopb Low.....	2.287, 2.289
Stopb Up.....	2.287, 2.289
Stopband.....	2.286
STORE.....	2.169, 2.171, 2.172, 2.303
STORE CH1.....	2.169, 2.171
STORE CH2.....	2.169, 2.171
STORE INSTRUMENT.....	2.299
STORE TRACE/LIST.....	2.303
Store traces and sweep lists.....	2.303
Storing complete instrument setup.....	2.299
Storing of setups.....	2.299
Strings.....	3.14
Suffix, numeric.....	3.8
Sum transfer function.....	2.229
Summary bit.....	3.26
SUPERFAST.....	2.206
Superimposed sinewave voltages.....	2.101
supplementary software	
installation.....	1.6
sweep.....	2.399
External.....	2.361
frequency sweeps.....	2.361
level sweeps.....	2.361
level trigger.....	2.361
Time-chart.....	2.361
Time-tick.....	2.361
Sweep	
automatic lists-.....	2.188
direction.....	2.96
frequency of selective rms measurement.....	2.187
lists RMS sel. sweep.....	2.191
manual lists.....	2.188
one-dimensional.....	2.91
steps are skipped.....	2.94
stop.....	2.5
two-dimensional.....	2.91
Sweep.....	2.358
Sweep Control.....	2.93
SWEEP CTRL2.99, 2.106, 2.109, 2.111, 2.115, 2.129, 2.133, 2.136, 2.141, 2.187, 2.188	
sweep direction.....	2.96
SWEEP LIST.....	2.327, 2.330
Sweep Mode.....	2.182, 2.193, 2.250
Sweep parameter	
X axis).....	2.95
Sweeps	
analyzer.....	2.187
generator.....	2.91
Switching off.....	1.4
Switching on.....	1.3
Switching on the UPL.....	2.13
Switching sweeps on and off.....	2.362
Switchover to Remote Control (RS232).....	3.358
Switchover to UPL user interface.....	3.343
SWP CONT RUNNING.....	2.363
SWP INVALID.....	2.363
SWP LIM REP.....	2.327
SWP MANU RUNNING.....	2.363

- SWP OFF ..... 2.363  
 SWP SNGL RUNNING ..... 2.363  
 SWP STOPPED ..... 2.363  
 SWP TERMINATED ..... 2.363  
 SYNC IN ..... 2.72  
 Sync Mode ..... 2.72  
 Sync Out  
   Source ..... 2.74  
   Type ..... 2.74  
 SYNC PLL ..... 2.74  
 Sync To  
   analyzer ..... 2.156  
   generator ..... 2.72  
 SYNC TO ANALYZER ..... 2.73  
 Synchronization (command) ..... 3.21  
 Syntax elements (command) ..... 3.15  
 SYSTEM ..... 2.5, 2.412  
 System files ..... 2.294  
 SYSTEM key ..... 2.233
- T**
- Test signal  
   intermodulation measurement ..... 2.111, 2.114  
   polarity measurement ..... 2.127  
 Text commands ..... 2.84  
 THD ..... 2.165  
 THD measurement ..... 2.199  
 THD+N ..... 2.205  
 THD+N / SINAD measurement ..... 2.208  
 THD+N/SINAD ..... 2.165  
 THD+N/SINAD measurement ..... 2.203  
 third analysis  
   lower band limit ..... 2.255  
   upper band limit ..... 2.255  
 Third analysis ..... 3.333  
 Third Analysis ..... 2.252  
 THIRD OCT ..... 2.118  
 Third Octave ..... 2.278  
 Third-octave ..... 2.290  
 Third-octave Filter ..... 2.290  
 Third-octave noise ..... 2.118  
 Time ..... 2.117, 2.162  
 TIME CHART ..... 2.160  
 Time domain display ..... 2.230  
 TIME TICK ..... 2.160  
 Timeout ..... 2.50, 2.177  
 Tolerance ..... 2.176  
 Tolerance ..... 2.50  
 Tolerance band ..... 2.42  
 TOP ..... 2.335  
 TOSLINK ..... 2.154  
 Total Gain factor ..... 2.104  
 Total Peak ..... 2.104  
 Total RMS ..... 2.105  
 TOTAL VOLT ..... 2.113, 2.116  
 TRACE A ..... 2.303, 2.305, 2.330, 2.344, 2.350, 2.389  
 TRACE A + B ..... 2.350, 2.389  
 Trace and spectrum display ..... 2.337  
 TRACE B ..... 2.303, 2.305, 2.330, 2.344, 2.350, 2.389  
 Trace data storing ..... 2.303  
 Trace Len ..... 2.233  
 Trace length ..... 2.233  
 Trace length of the signal ..... 2.233  
 Trace printout ..... 2.389  
 TRACEA ..... 2.341  
 TRACEB ..... 2.341  
 Traces ..... 2.302
- Traces to be used ..... 2.337  
 Tracing of measured values  
   continuous ..... 2.160  
   due to frequency change ..... 2.160  
   due to voltage change ..... 2.160  
   fixed number ..... 2.163  
   fixed time interval ..... 2.163  
 Tracing of measured values at regular intervals ..... 2.160  
 Transfer function ..... 2.292  
 Transfer Function ..... 2.244  
 Transfer of parameters ..... 2.403  
 Triangle ..... 2.86, 2.122  
 Triangular distribution ..... 2.86  
 Trig Chan ..... 2.233  
 Trig Level ..... 2.183, 2.232  
 Trig Slope ..... 2.232  
 Trigger  
   Waveform ..... 2.230  
 Trigger ..... 2.159  
 Trigger condition for tracing measured values ..... 2.159  
 Trigger event ..... 2.160  
 trigger source ..... 2.233  
 TRIGGERED  
   RMS measurement ..... 2.180  
 True rms measurement ..... 2.165, 2.178  
 twelfth analysis  
   lower band limit ..... 2.258  
   upper band limit ..... 2.259  
 Twelfth Analysis ..... 2.256  
 two-dimensional sweep ..... 2.295  
 Two-tone signal to SMPTE ..... 2.111  
 Type ..... 2.389
- U**
- UNBAL  
   Generator ..... 2.66, 2.139  
 UNBAL BNC  
   analyzer ..... 2.154  
 Unbal Out ..... 2.71  
 Unbalanced output ..... 2.68  
 Unbalanced output (Output UNBAL, BNC) ..... 2.69  
 UNDERSAMPLE ..... 2.231  
 Undersampling FFT ..... 2.226  
 UNDO ..... 2.341  
 Unit ..... 2.168, 2.201, 2.206, 2.213, 2.215, 2.218, 2.232  
   ..... 2.245, 2.332  
 UNIT ..... 2.344, 2.347  
 Unit Ch1 ..... 2.168, 2.181, 2.186, 2.197, 2.198, 2.220  
   ..... 2.236, 2.239, 2.241, 2.243, 2.248, 2.254, 2.258  
 Unit Ch2 ..... 2.168, 2.181, 2.186, 2.197, 2.198, 2.220  
   ..... 2.236, 2.239, 2.241, 2.243, 2.248, 2.254, 2.258  
 Unit/Label ..... 2.332  
 Units  
   conversion formulas for entry of values ..... 2.61  
   conversion formulas ..... 2.57  
   display of measurement results ..... 2.57  
   for measurement results ..... 2.57  
   for value inputs ..... 2.57  
   function labelling ..... 2.329  
   IEC-bus notation ..... 2.59  
   list of all ..... 2.57  
   measurement result output ..... 2.168  
   of measurement results ..... 2.168  
   output of measurement result ..... 2.239  
   result display ..... 2.241
- Universal Sequence Controller

- Switchover to UPL..... 3.343
  - Universal Sequence Controller (UPL B10)..... 3.337
  - Universal Sequence Controller UPL-B10..... 3.337
    - Differences to IEC/IEEE-bus Control..... 3.341
    - First steps (readout of measurement results)..... 3.340
    - Output of block data..... 3.342
    - Reading in responses..... 3.341
    - Reading out Block data..... 3.342
  - UNZOOM..... 2.341
  - UPL IEC adr..... 2.390
  - UPL software
    - command line options..... 1.11
    - command line parameters at power-up..... 1.13
    - integration of programs..... 1.10
    - restarting..... 1.10
  - UPL-B1..... 2.401
  - UPL-B10..... 1.5, 2.401
  - UPL-B10 Universal sequence controller..... 3.337
  - UPL-B2..... 2.401
  - UPL-B21..... 1.5, 2.78, 2.401
  - UPL-B22..... 1.5, 2.401
  - UPL-B23..... 1.5, 1.7, 2.85, 2.134, 2.401
  - UPL-B29..... 2.401
  - UPL-B33..... 1.5, 2.401
  - UPL-B4..... 1.5, 2.401
  - UPL-B5..... 2.401
  - UPL-B6..... 1.5, 2.401
  - UPL-B8..... 1.5, 2.401
  - UPL-B9..... 1.5, 2.401
  - UPLCFG..... 1.13
  - Upper case (command)..... 3.37
  - Upper Freq..... 2.121
  - UPPER FREQ..... 2.112
  - Useful signal..... 2.111
  - Useful sinewave signal..... 2.212
  - User data..... 2.82
  - USER DEF..... 2.101, 2.118, 2.297
  - User files..... 2.294
  - USER L..... 2.353
  - User Label..... 2.329
  - User Mode..... 2.82
  - USER R..... 2.353
  - User-definable filter..... 2.284
  - USERKEYB.BAT..... 1.10, 1.13
- V**
- Valid Chan..... 2.78
  - Validity bit..... 2.352
  - VALUE..... 2.73
  - Value commands..... 2.84
  - Value entry, rotary knob, numeric keypad..... 2.35
  - Value of axes, printout..... 2.389
  - VARI (PLL)..... 2.155
  - Vari Mode..... 2.136
  - Variation..... 2.89, 2.105, 2.123, 2.126, 2.164
  - Variation mode..... 2.136
  - Variation Mode..... 2.136
  - Version display..... 2.401
  - VGA
    - interface..... 2.411
    - monitor..... 2.394
    - monitor connector 15-contact..... 2.11
  - VGA monitor..... 2.394
  - VIDEO 50..... 2.72
  - VIDEO 60..... 2.72
  - VIEW OFF..... 2.342
  - VIEW PCX..... 2.298
  - Virtual Drive
    - installation..... 1.7
  - VOLT..... 2.95
  - Volt Ch1..... 2.130
  - VOLT CH1..... 2.161
  - VOLT CH1&2..... 2.128
  - Volt Ch2..... 2.130
    - 1..... 2.131
  - VOLT CH2..... 2.161
  - VOLT FILE..... 2.97, 2.141
  - VOLT LF\UF..... 2.112
  - Volt Mode..... 2.128
  - Volt No (i)..... 2.104
  - Volt Range..... 2.67
  - VOLT RMS..... 2.122, 2.125
  - VOLT&RATIO..... 2.128
  - Voltage..... 2.107, 2.109, 2.127, 2.130, 2.133, 2.139, 2.140
    - generator..... 2.100
    - increase..... 2.101
    - range..... 2.149
    - sweeps..... 2.97
  - VOLTAGE..... 2.136, 2.137
  - voltage check..... 2.67
  - voltage limitation..... 2.67
  - VOLTAGE PEAK..... 2.121, 2.125
  - Voltage selector..... 1.1
  - Voltsource..... 2.305
  - Volume..... 2.261
- W**
- W&F..... 2.165
  - Waterfall..... 2.223
  - WATERFALL..... 2.328
  - Waveform..... 2.165
  - WAVEFORM..... 2.165
  - Waveform display..... 2.230
  - Ways of presentation..... 2.15
  - Ways of Starting the Analyzer, Ext. Sweep..... 2.159
  - Weighting..... 2.217
  - Weighting filters..... 2.279
  - WHITE..... 2.118, 2.374
  - White noise..... 2.118
  - WIDE..... 2.206
  - Width..... 2.290
  - Width of a Filter..... 2.289
  - Window..... 2.245
  - Window..... 2.210, 2.218, 2.222
    - FFT..... 2.173
  - Window functions..... 2.222
  - Window functions of FFT..... 2.228
  - WORD CLK..... 2.72, 2.74
  - Word width
    - digital generator..... 2.75
  - Work dir..... 2.321
  - working directory..... 2.296
  - Working Directory..... 2.38
  - WOW & FL..... 2.165
  - Wow & Flutter..... 2.217
  - Wow&Flutter..... 2.165
  - WRD CLK INV..... 2.72
  - Write protection..... 2.300

**X**

X AXIS.....	2.303, 2.389
X Axis (sweep) .....	2.95
X Pos.....	2.336
X scaling.....	2.376
X-axis (sweep).....	2.91
XLR output .....	2.139
XON/XOFF.....	2.392

**Y**

Y Pos.....	2.336
Y scaling.....	2.376

**Z**

Z Axis .....	2.95, 2.389
Z AXIS.....	2.303
Z sweep.....	2.91
Z-axis .....	2.91
ZERO .....	2.79, 2.81, 2.82
Zero Auto.....	2.399
Zeros .....	2.292
ZOOM.....	2.340
Zoom Fact .....	2.223
Zoom factor .....	2.223
Zooming frequency range FFT.....	2.223
Zooming zone .....	2.224
Z-parameter.....	2.91

<b>-Π</b> ... + .....	2.229, 2.241
-----------------------	--------------

**#**

* CURSOR .....	2.314, 2.334
----------------	--------------

**\***

* CURSOR.....	2.312, 2.314
*CURSOR.....	2.307, 2.321

**+**

+1000 ppm .....	2.86
-----------------	------

**=**

= SPEAKER .....	2.247, 2.263
-----------------	--------------

**0**

0 dB .....	2.164, 2.174
------------	--------------

**1**

1/3 OCT FLT .....	2.273
1/12 OCTAVE .....	2.256
1/3 OCT FLT .....	2.290
1/3 OCTAVE .....	2.155, 2.165, 2.2402, 2.52
1024 kHz.....	2.72
12 dB Auto .....	2.164
1-k block.....	2.306

**2**

2 Sigma.....	2.206, 2.217
2Sigma weighting.....	2.21, 2.206
2/0 192 kb/s .....	2.135

**3**

30 dB Auto .....	2.164
32 kHz.....	2.73
32.0 (PLL) .....	2.145, 2.155
3-panel display.....	2.29, 2.32
30 dB Auto .....	2.174

**4**

44,1 kHz.....	2.73
44.1 (PLL) .....	2.145, 2.155
48 kHz.....	2.73
48.0 (PLL) .....	2.145, 2.155
42 Hz.....	2.135

**5**

5.1 448 kb/s .....	2.135
--------------------	-------

**9**

997 Hz.....	2.135
-------------	-------